

NX7437 Series

Data Sheet

R08DS0036EJ0100

Rev.1.00

Mar 03, 2011

LASER DIODE

1 490 nm InGaAsP MQW-FP LASER DIODE COAXIAL MODULE FOR OTDR APPLICATION

DESCRIPTION

The NX7437 Series is a 1 490 nm Multiple Quantum Well (MQW) structured Fabry-Perot (FP) laser diode coaxial module with single mode fiber. This module is specified to operate under pulsed condition and designed for light source of Optical Time Domain Reflectometer (OTDR).

FEATURES

- High output power $P_f = 90 \text{ mW} @ I_{FP} = 400 \text{ mA}^{*1}$
- Long wavelength $\lambda_c = 1 490 \text{ nm}$
- NX7437AG-AA has a built-in monitor PD.

*1 Pulse Conditions: Pulse width (PW) = 10 μs , Duty = 1%



PACKAGE DIMENSIONS (UNIT: mm)

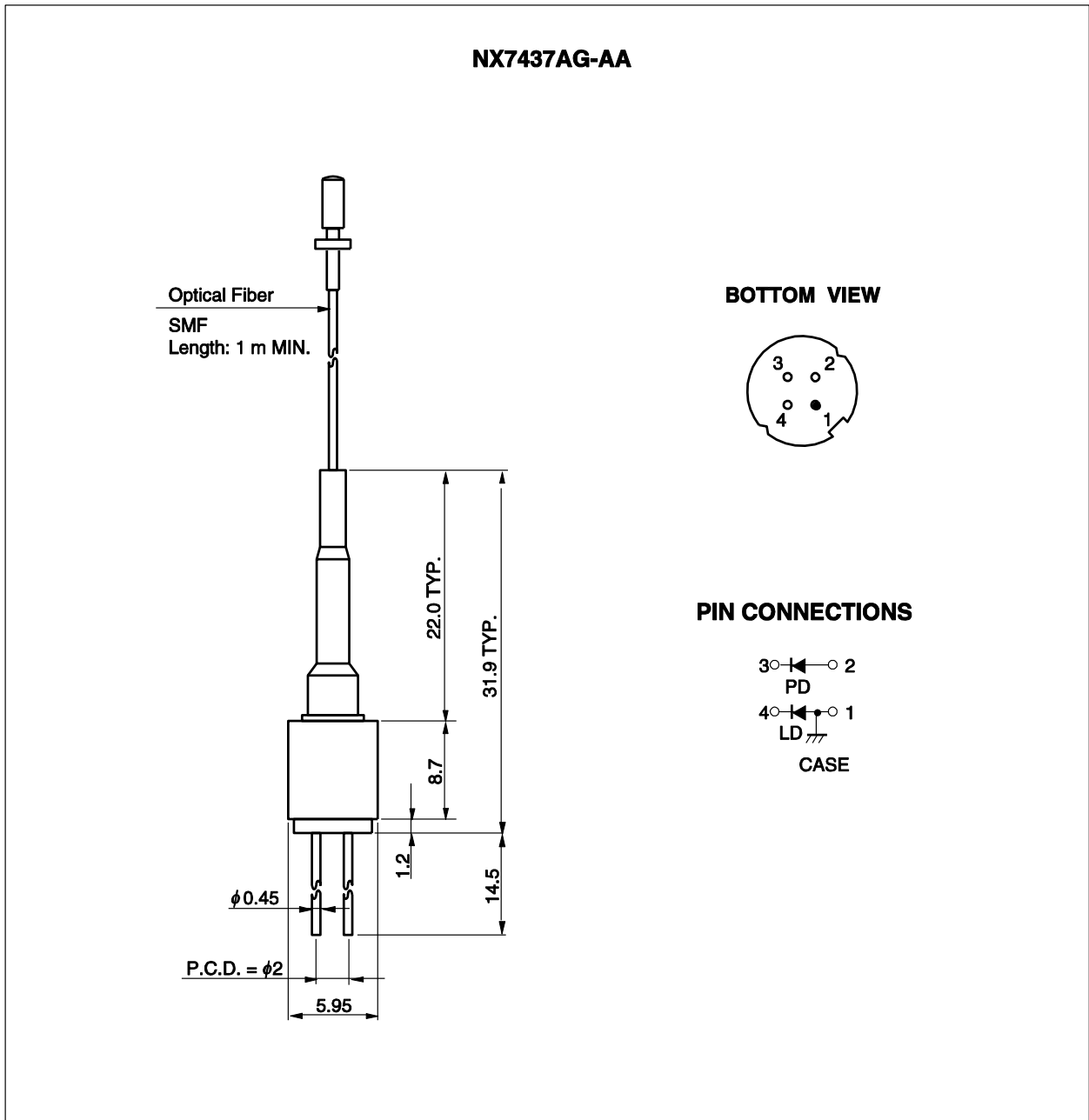

NX7437BF-AA

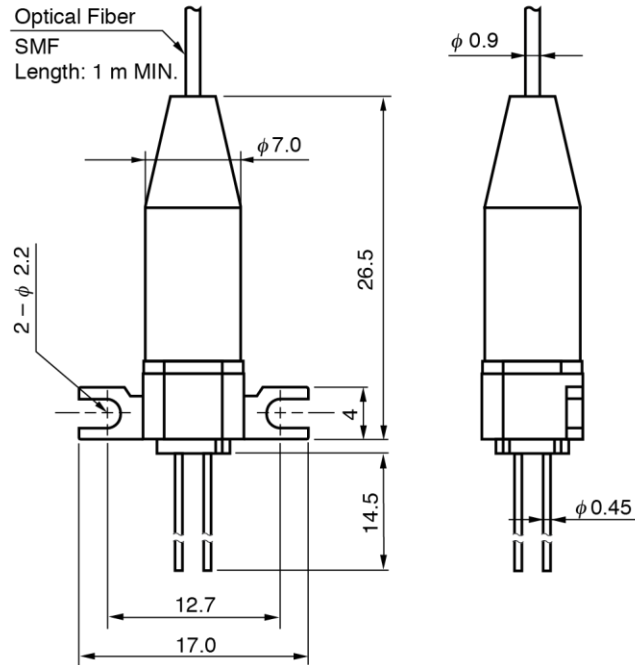

PIN CONNECTIONS

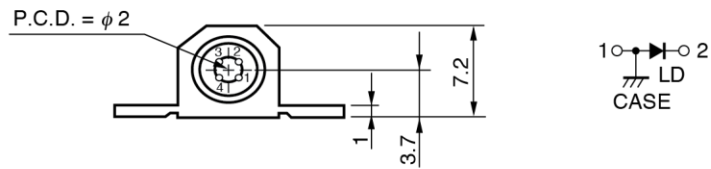

OPTICAL FIBER CHARACTERISTICS

Parameter	Specification	Unit
Mode Field Diameter	9.5±1	μm
Cladding Diameter	125±2	μm
Maximum Cladding Noncircularity	2	%
Maximum Core/Cladding Concentricity	1.6	%
Outer Diameter	0.9±0.1	mm
Cut-off Wavelength	1 140 to 1 280	nm
Minimum Fiber Bending Radius	30	mm
Fiber Length	1 000 MIN.	mm

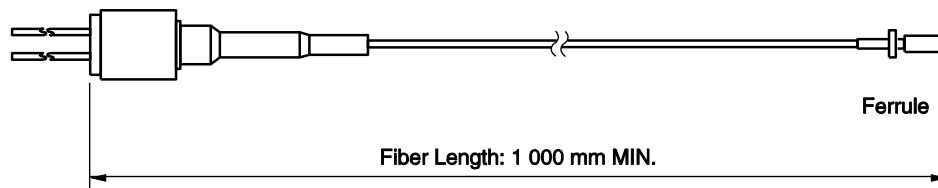

ORDERING INFORMATION

Part Number	Flange Type
NX7437AG-AA	without flange
NX7437BF-AA	flat mount flange

ABSOLUTE MAXIMUM RATINGS

Parameter	Symbol	Ratings	Unit
Pulsed Forward Current ^{*1}	I _{FP}	600	mA
Reverse Voltage	V _R	2.0	V
Reverse Voltage (monitor PD, NX7437AG-AA only)	V _{RM}	10	V
Forward Current (monitor PD, NX7437AG-AA only)	I _{FPM}	2.0	mA
Operating Case Temperature	T _C	-20 to +60	°C
Storage Temperature	T _{stg}	-40 to +85	°C
Lead Soldering Temperature	T _{slid}	350 (3 sec.)	°C
Relative Humidity (noncondensing)	RH	85	%

*1 Pulse Condition: Pulse Width (PW) = 10 μ s, Duty = 1%

ELECTRO-OPTICAL CHARACTERISTICS (T_c = 25°C)

Parameter	Symbol	Conditions	MIN.	TYP.	MAX.	Unit
Forward Voltage	V _{FP}	I _{FP} = 400 mA, PW = 10 μs, Duty = 1%			3.0	V
Threshold Current	I _{th}			15	50	mA
Optical Output Power from Fiber	P _f	I _{FP} = 400 mA, PW = 10 μs, Duty = 1%	60	90		mW
Center Wavelength	λ _c	RMS (-20 dB), I _{FP} = 400 mA, PW = 10 μs, Duty = 1%	1 470		1 510	nm
Spectral Width	σ	RMS (-20 dB), I _{FP} = 400 mA, PW = 10 μs, Duty = 1%		5	10	nm
Rise Time	t _r	10-90%			2.0	ns
Fall Time	t _f	90-10%			2.0	ns
Monitor Current (NX7437AG-AA only)	I _m	P _{fcw} = 2 mW, V _{RM} = 2 V	0.02		0.8	mA

ELECTRO-OPTICAL CHARACTERISTICS (T_c = 0 to +60°C)

Parameter	Symbol	Conditions	MIN.	TYP.	MAX.	Unit
Optical Output Power from Fiber	P _f	I _{FP} = 400 mA, PW = 10 μs, Duty = 1%	40			mW
Spectral Width	σ	RMS (-20 dB), I _{FP} = 400 mA, PW = 10 μs, Duty = 1%		5	10	nm

TYPICAL CHARACTERISTICS ($T_c = 25^\circ\text{C}$, unless otherwise specified)

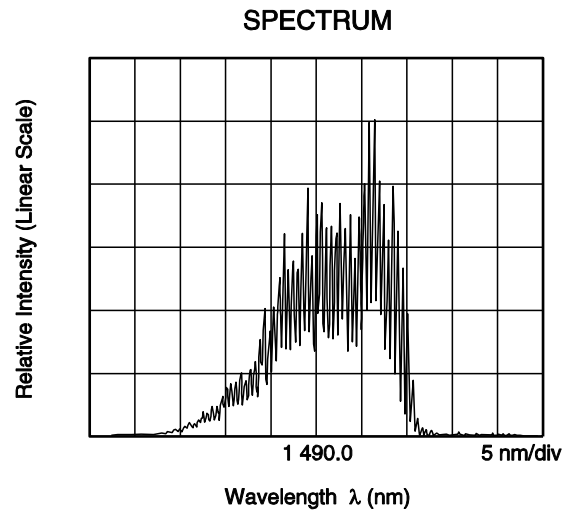
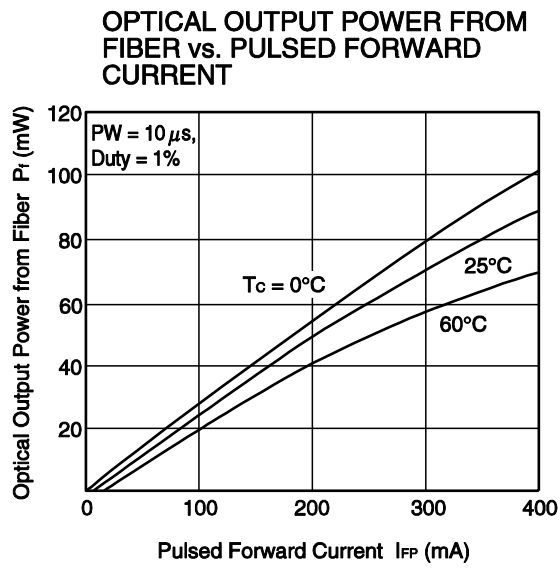

Remark The graphs indicate nominal characteristics.

REFERENCE

Document Name	Document No.
Opto-Electronics Devices Pamphlet ^{*1}	PX10160E

*1 Published by the former NEC Electronics Corporation.

SAFETY INFORMATION ON THIS PRODUCT



SEMICONDUCTOR LASER

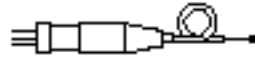

AVOID EXPOSURE TO INVISIBLE LASER RADIATION
Laser Radiation is emitted from this aperture

<p>Warning Laser Beam</p>	<p>A laser beam is emitted from this diode during operation. The laser beam, visible or invisible, directly or indirectly, may cause injury to the eye or loss of eyesight.</p> <ul style="list-style-type: none"> • Do not look directly into the laser beam. • Avoid exposure to the laser beam, any reflected or collimated beam.
<p>Caution GaAs Products</p>	<p>This product uses gallium arsenide (GaAs). GaAs vapor and powder are hazardous to human health if inhaled or ingested, so please observe the following points.</p> <ul style="list-style-type: none"> • Follow related laws and ordinances when disposing of the product. If there are no applicable laws and/or ordinances, dispose of the product as recommended below. <ol style="list-style-type: none"> 1. Commission a disposal company able to (with a license to) collect, transport and dispose of materials that contain arsenic and other such industrial waste materials. 2. Exclude the product from general industrial waste and household garbage, and ensure that the product is controlled (as industrial waste subject to special control) up until final disposal. • Do not burn, destroy, cut, crush, or chemically dissolve the product. • Do not lick the product or in any way allow it to enter the mouth.
<p>Caution Optical Fiber</p>	<p>A glass-fiber is attached on the product. Handle with care.</p> <ul style="list-style-type: none"> • When the fiber is broken or damaged, handle carefully to avoid injury from the damaged part or fragments.

Revision History	NX7437 Series Data Sheet
-------------------------	---------------------------------

Rev.	Date	Description	
		Page	Summary
1.00	Mar 03, 2011	-	First edition issued

All trademarks and registered trademarks are the property of their respective owners.