

Regulator IC with the Soft-Start Monolithic IC MM192x Series

Outline

This IC is 1A regulator IC with soft-start. When Cs pin is connected with a capacitor, the output voltage is started up slowly. This IC can reduce a rush current by the soft-start.

Therefore a transformer in a power supply for this IC can be small, and it is possible to reduce a total cost in the power supply system. And this IC can be turned off by Cont pin.

Package TO-252-5 or HSOP-8 were used for this device.

Features

1. Input Voltage Range	2.4V~12V
2. Output Voltage Range	12V~5.1V
3. Output Voltage accuracy 1 ($V_{OUT} < 1.5V$) :	$V_{OUT} \pm 30mV$
4. Output Voltage accuracy 2 ($V_{OUT} \geq 1.5V$) :	$V_{OUT} \pm 2\%$
5. Maximum Output Current	1A
6. Supply Current	1mA typ. (No-Load Input Current) 1 μ A max. (OFF)
7. Dropout Voltage	0.3V max. ($I_o=500mA$), 0.6V max. ($I_o=1A$)
8. Line Regulation	10mV typ., 20mV max. ($I_o=250mA$)
9. Load Regulation	20mV typ., 100mV max. ($I_o=1mA\sim 1A$)
10. Output Capacitor	1 μ F
11. Output Rise Time	10msec typ. (C_s Capacitor=0.1 μ F)
12. With ON/OFF Control Pin	

Package

TO-252-5
HSOP-8A

Applications

1. DVD Recorders
2. Blu-ray Disc Recorders
3. TVs

Block Diagram

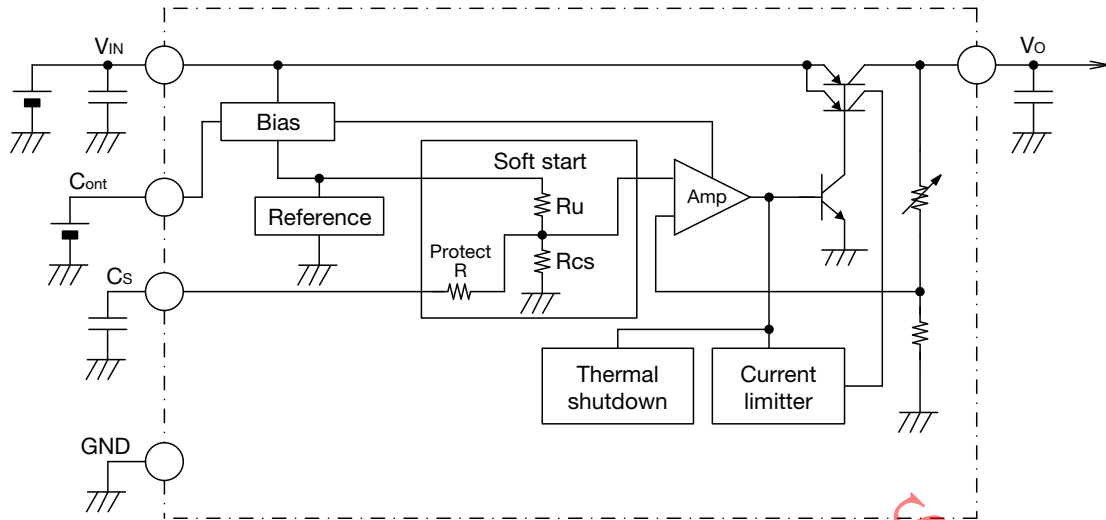

Pin Assignment

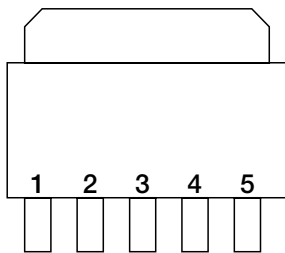

TO-252-5
(TOP VIEW)

1	Cont
2	V _{IN}
3	GND
4	V _O
5	C _s

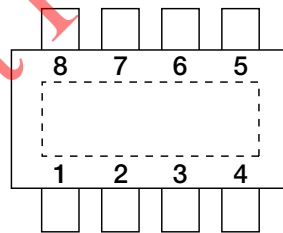

HSOP-8A
(TOP VIEW)

1	V _O
2	NC
3	GND
4	C _s
5	Cont
6	NC
7	NC
8	V _{IN}

Phased Out Products

Pin Description

TO-252-5

Pin No.	Pin name	Functions
1	Cont	ON/OFF-Control pin
		Cont OUTPUT
		Low OFF
		High ON
Connect Cont pin with V _{IN} pin, when it is not used.		
2	V _{IN}	Voltage-supply pin
3	GND	Ground
4	V _O	Output pin
5	Cs	Soft-start pin

HSOP-8A

Pin No.	Pin name	Functions
1	V _O	Output pin
2	NC	No connection
3	GND	Ground
4	Cs	Soft-start pin
5	Cont	ON/OFF-Control pin
		Cont OUTPUT
		Low OFF
		High ON
Connect Cont pin with V _{IN} pin, when it is not used.		
6	NC	No connection
7	NC	No connection
8	V _{IN}	Voltage-supply pin

Absolute Maximum Ratings (Except where noted otherwise Ta=25°C)

Item	Symbol	Ratings	Units
Storage Temperature	T _{STG}	-40~+150	°C
Supply Voltage	V _{IN}	13.2	V
Power Dissipation	Pd	2.5(Note1)	TO-252-5
		1.8(Note2)	HSOP-8A
			W

Note1 : With the double sided PC Board of glass epoxy
(Copper plane 80%, 150 × 100 × 1.0mm)

Note2 : With the double sided PC Board of glass epoxy
(Copper plane 80%, 37 × 37 × 1.6mm)

Recommended Operating Conditions (Except where noted otherwise Ta=25°C)

Item	Symbol	Ratings	Units
Operating Ambient Temperature	T _{JOP}	-40~85	°C
Operating Voltage	V _{OP}	V _O <2.0V 2.4~12	V
		V _O ≥2.0V V _O (typ.)+0.5~12	
Output Current	I _O	0~1	A

Electrical Characteristics 1 (Except where noted otherwise $V_{IN}=V_O+1V$, $V_{Cont}=V_{IN}$, $T_a=25^\circ C$)

Item	Symbol	Measurement conditions	Min.	Typ.	Max.	Units
Input Current(OFF)	I_{inoff}	$V_{Cont}=0V$			1	μA
No-Load Input Current	I_{in}	$I_o=0mA$		1	2	mA
Output Voltage Tolerance	V_o	$I_o=250mA$ $V_o \geq 1.5V$	-2		2	%
		$I_o=250mA$ $V_o < 1.5V$	-30		30	mV
Line Regulation	V_{LINE}	$V_{IN}=V_o+1.5 \sim V_o+2.5V$, $I_o=250mA$		10	20	mV
Load Regulation	V_{LOAD}	$1mA \leq I_o \leq 1A$		20	100	mV
Dropout Voltage 1	V_{io1}	$V_{IN}=V_o-0.2V$, $I_o=500mA$			0.3	V
Dropout Voltage 2	V_{io2}	$V_{IN}=V_o-0.2V$, $I_o=1A$			0.6	V
Ripple Rejection	RR	$f=1kHz$, $V_{ripple}=1V$, $I_o=250mA$ (Note3)		70		dB
V_{OUT} Temperature Coefficient	$\Delta V_{OUT}/\Delta T$	$-40 \leq T_{OP} \leq 85^\circ C$ (Note3)		± 100		ppm/ $^\circ C$
Output Rise Time	t_r	$V_{Cont}=L \rightarrow H \sim V_o \times 0.9$, $C_s=0.1\mu F$ (Note3)		10		ms
Cs Discharge Resistance	R_{cs}		63	90	117	k Ω
Cont Pin Input Current	I_{Cont}	$V_{Cont}=5V$	10	20	30	μA
Cont Pin High Threshold Level	V_{ContH}		2			V
Cont Pin Low Threshold Level	V_{ContL}				1	V
Thermal shutdown	TSD	(Note3, 4)	110	130	150	$^\circ C$

Note3 : The parameter is guaranteed by design.

Note4 : The parameter has Thermal shutdown hysteresis.

Phased Out Products

Electrical Characteristics 2 (Except where noted otherwise $V_{IN}=V_O+0.5V$, $I_O=1mA$, $T_a=25^\circ C$)

Model No.	Measurement Conditions	Output Voltage (V)			
		Min.	Typ.	Max.	
MM1921C	$T_a=25^\circ C$ $V_{IN}=2.4V$ $I_O=250mA$	1.170	1.2	1.230	
MM1921Z		1.230	1.26	1.290	
MM1921D		1.270	1.3	1.330	
MM1921E		1.370	1.4	1.430	
MM1921F		1.470	1.5	1.530	
MM1921G		1.568	1.6	1.632	
MM1921H		1.666	1.7	1.734	
MM1921J		1.764	1.8	1.836	
MM1921K		1.862	1.9	1.938	
MM1922A		$T_a=25^\circ C$ $V_{IN}=V_O+1V$ $I_O=250mA$	1.960	2.0	2.040
MM1922B			2.058	2.1	2.142
MM1922C	2.156		2.2	2.244	
MM1922D	2.254		2.3	2.346	
MM1922E	2.352		2.4	2.448	
MM1922F	2.450		2.5	2.550	
MM1922G	2.548		2.6	2.652	
MM1922H	2.646		2.7	2.754	
MM1922J	2.744		2.8	2.856	
MM1922K	2.842		2.9	2.958	
MM1923A	2.940		3.0	3.060	
MM1923B	3.038		3.1	3.162	
MM1923C	3.136		3.2	3.264	
MM1923D	3.234		3.3	3.366	
MM1923E	3.332		3.4	3.468	
MM1923F	3.430		3.5	3.570	
MM1923G	3.528		3.6	3.672	
MM1923H	3.626		3.7	3.774	
MM1923J	3.724		3.8	3.876	
MM1923K	3.822		3.9	3.978	
MM1924A	3.920		4.0	4.080	
MM1924B	4.018		4.1	4.182	
MM1924C	4.116		4.2	4.284	
MM1924D	4.214	4.3	4.386		
MM1924E	4.312	4.4	4.488		
MM1924F	4.410	4.5	4.590		
MM1924G	4.508	4.6	4.692		
MM1924H	4.606	4.7	4.794		
MM1924J	4.704	4.8	4.896		
MM1924K	4.802	4.9	4.998		
MM1925A	4.900	5.0	5.100		
MM1925B	4.998	5.1	5.202		
MM1923W	3.283	3.35	3.417		
MM1923Y	3.773	3.85	3.927		

Phased Out Products

Measuring Circuit

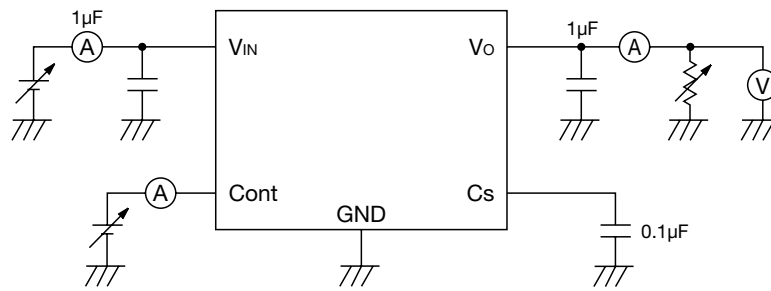

(Reference example of external parts)

- Output capacitor Co Ceramic capacitor (B temperature characteristics) 1μF
- Input Capacitor C_{IN} Ceramic capacitor 1μF
- Softstart Capacitor Cs Ceramic capacitor 0.1μF

Application Circuit

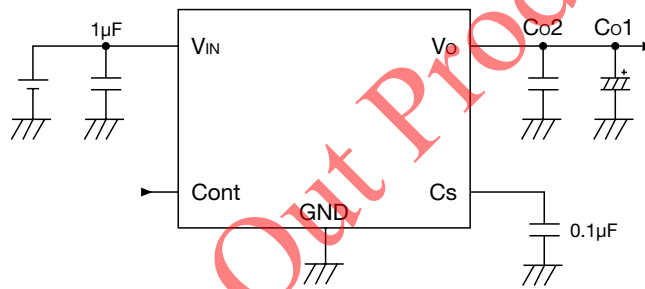

C _{in}	Co1			Co2		
	Capacity	Kind	Characteristics	Capacity	Kind	Characteristics
-40°C ≤ Top ≤ 85°C				1.0μFor more	Ceramic	B type/X5R
	Free	AL electrolytic	Standard	1.0μFor more	Ceramic	B type/X5R
Using only by AL electrolytic does not recommend.						

· Note

1. The output capacitor is required between output and GND to prevent oscillation.
2. The ESR of capacitor must be defined in ESR stability area.
3. The wire of Vcc and GND is required to print full ground plane for noise and stability.
4. The input capacitor must be connected a distance of less than 1cm from input pin.
5. In case the output voltage is above the input voltage, the overcurrent flow by internal parasitic diode from output to input. Therefore please connect a schottky barrier diode from output to input.

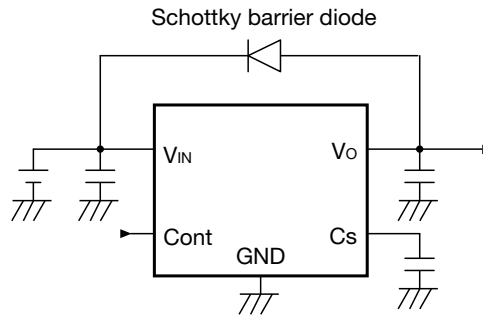

6. Please connect the soft-start capacitor(Cs) more than 0.01 μ F, if not, there's possible to occur oscillation.
7. The output capacitor and the softstart capacitor must be connected it within the limits a rush current peak level 1A showed in the typical performance characteristics.
8. When rush current exceeds 1A, it is restricted with the current limit set up with the chip, an output rise time is uncontrollable by soft-start capacitor.
9. When use connecting Vin and Cont, in the case of starting Vin in input rise time longer then the set-up soft-start time, an output rise time is decied by a Vin input rise time.
 Moreover, in this case, in the case of the Vo-model \leq 2.4V, since there is a period when output voltage is raised to input voltage by Vin \leq 2.4V, Vin input rise time earlier than the set-up soft-start time is recommended.
10. When use Vin in a smallll dropout voltage, there's possible to occur oscillation.
 In this case, connect the input capacitor(Cin) or output capacitor(Co) more than 10 μ F is recommended.

Phase-OUT Products

Timing Chart

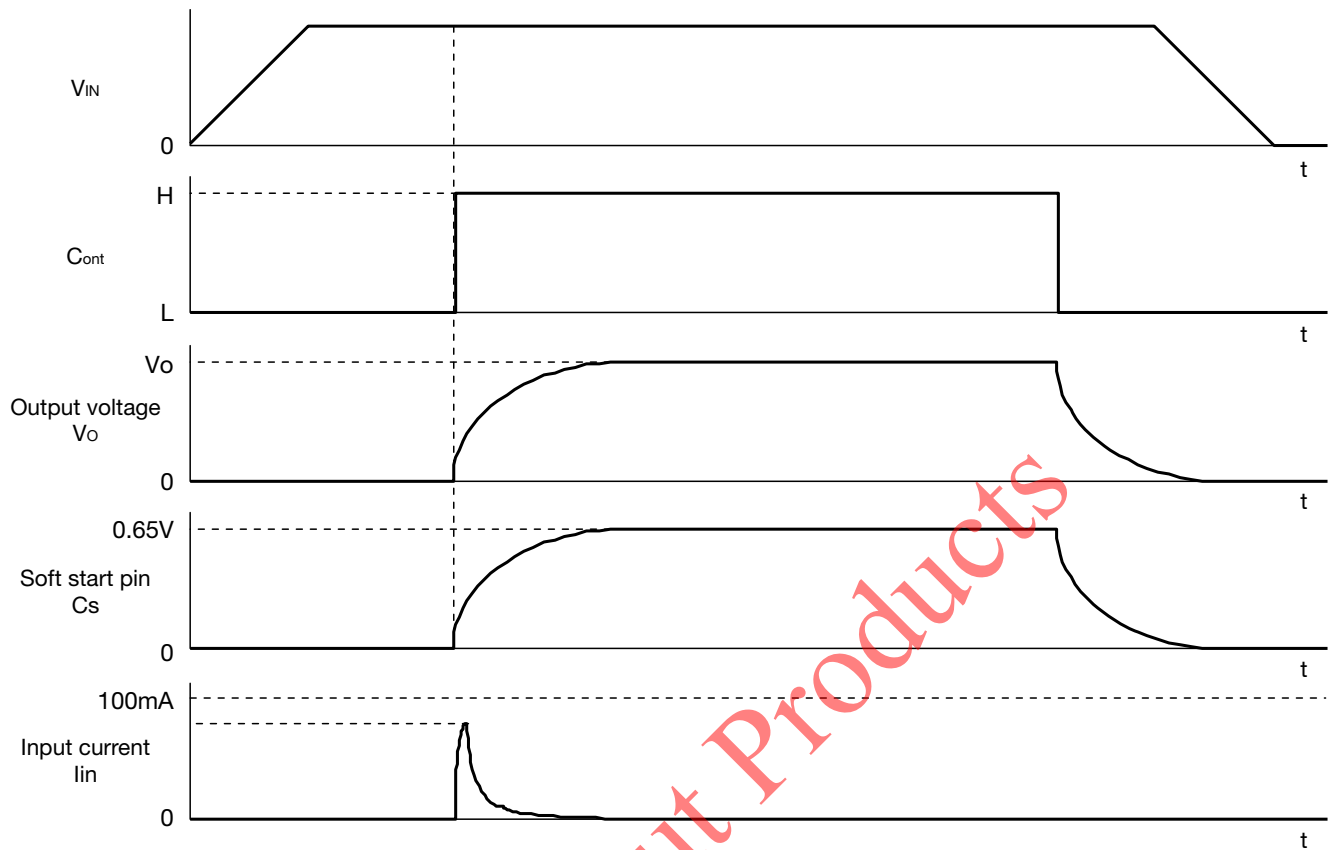

Phased Out Products

About Power Dissipation

This IC's GND pin and Heat Spreader Bottom effectively radiate heat. By increasing these copper foil pattern area of PCB, Power dissipation improves. Please kindly design PCB pattern taking care of above features about power dissipation.

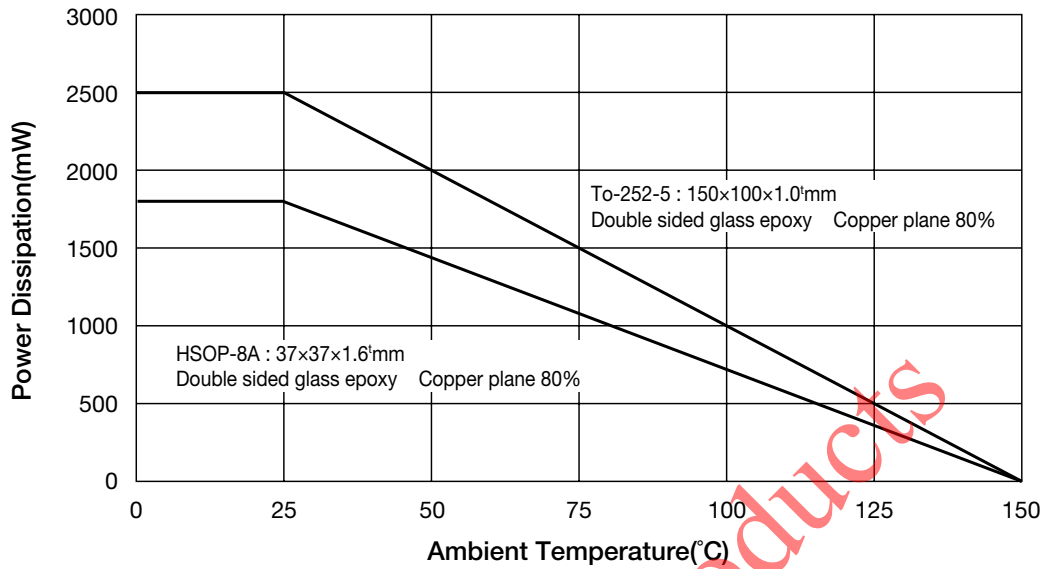

Land Pattern Recommendation

HSOP-8A

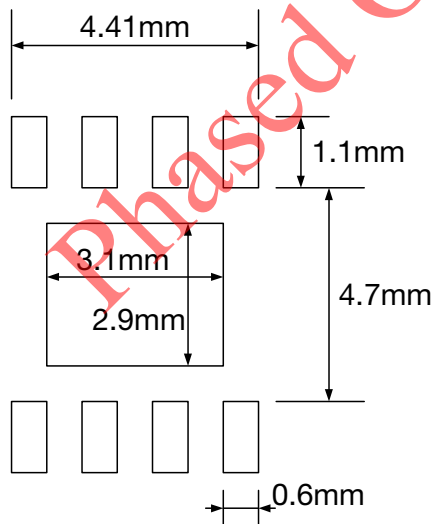

TO-252-5

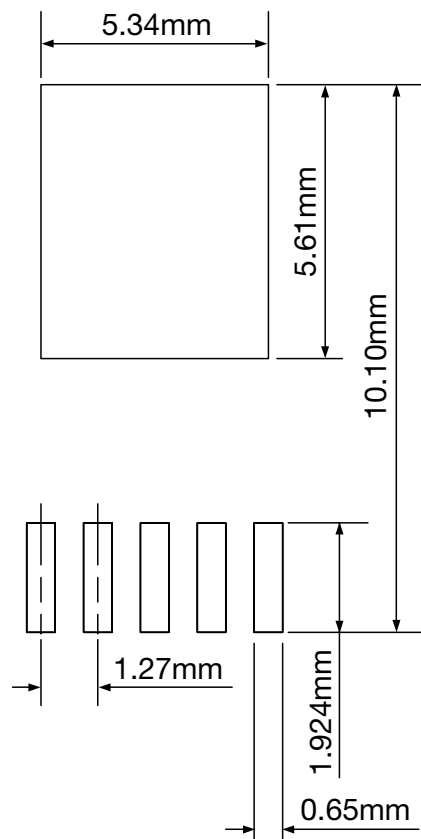

Note : These Dimensions are the reference values.

Characteristics (Vo=1.26V) (Except where noted otherwise VIN=2.4V, VCont=VIN, Cin=1.0μF, Co=1.0μF, Cs=0.1μF, Ta=25°C)

Output - Input voltage

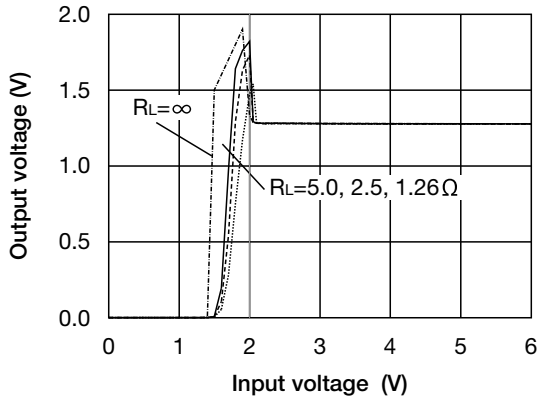

Line regulation

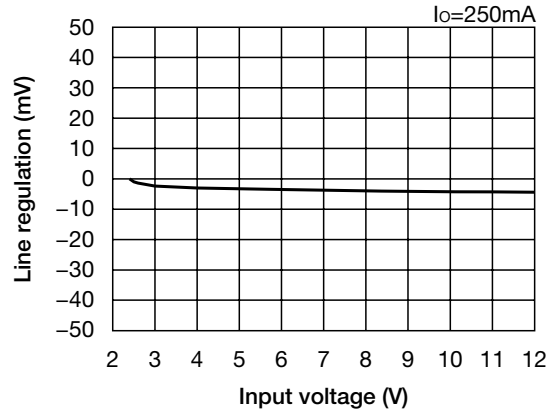

Load current - Output voltage

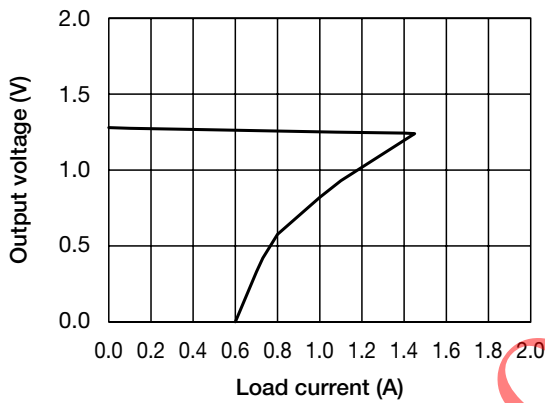

Load regulation

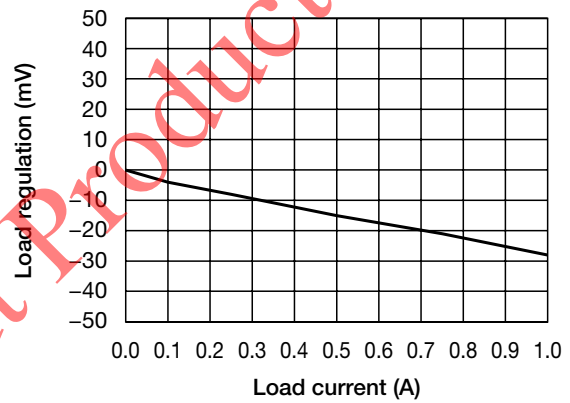

Input voltage - Input current

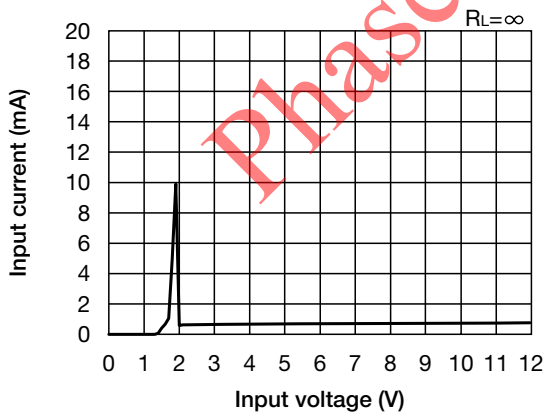

Phased Out Products

Output voltage - Temperature

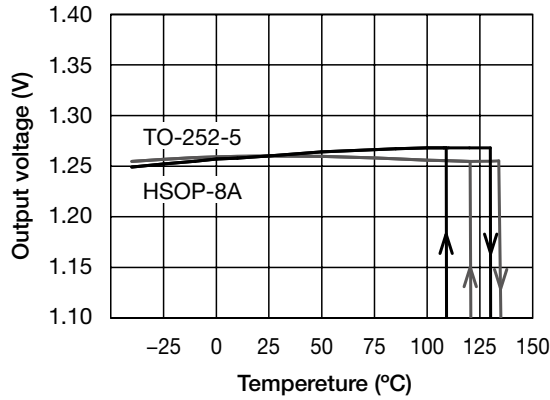

Output rise time

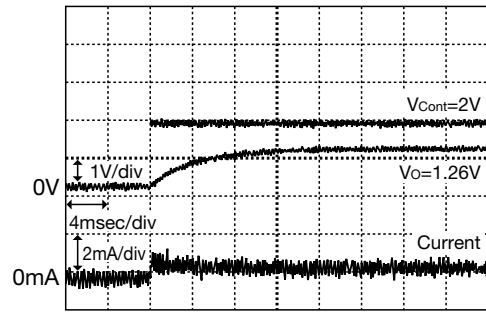

Rush current peak level

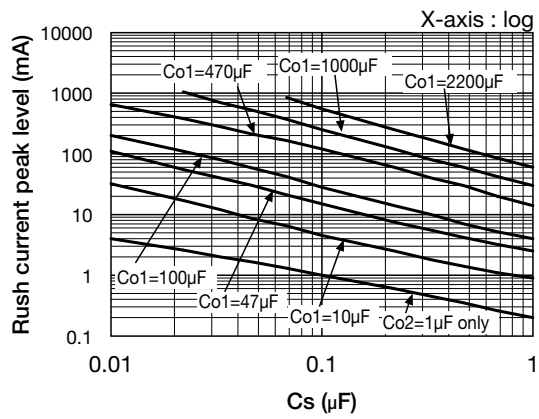

* Please refer to NOTE 7,8.

ESR Stable area

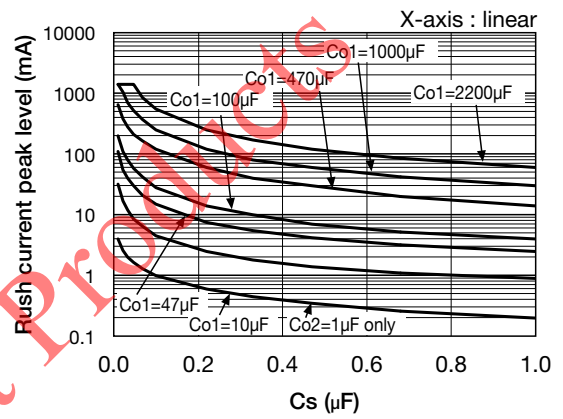

* Please refer to NOTE 7,8.

Phased Out Product

Characteristics (Vo=3.3V) (Except where noted otherwise $V_{IN}=V_O+1V$, $V_{Cont}=V_{IN}$, $C_{in}=1.0\mu F$, $C_o=1.0\mu F$, $C_s=0.1\mu F$, $T_a=25^\circ C$)

■ Output - Input voltage

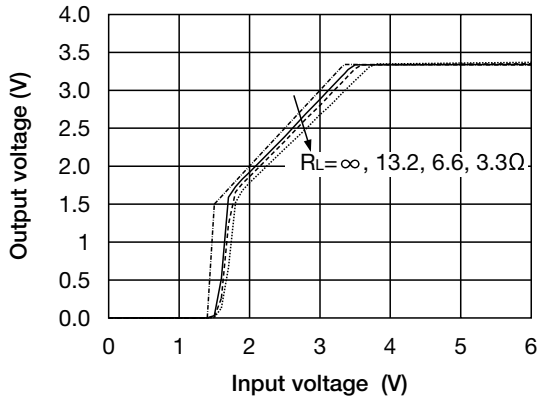

■ Line regulation

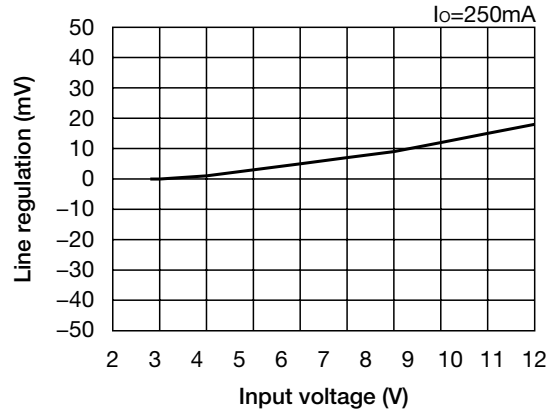

■ Load current - Output voltage

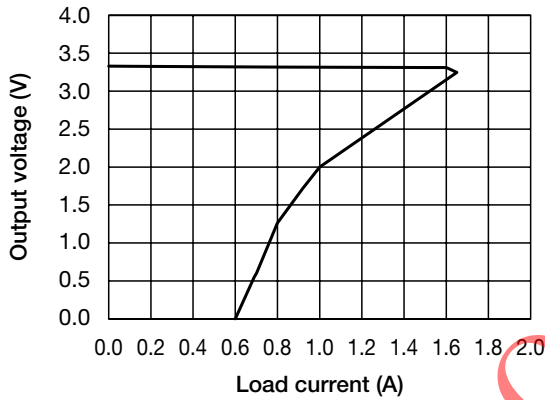

■ Load regulation

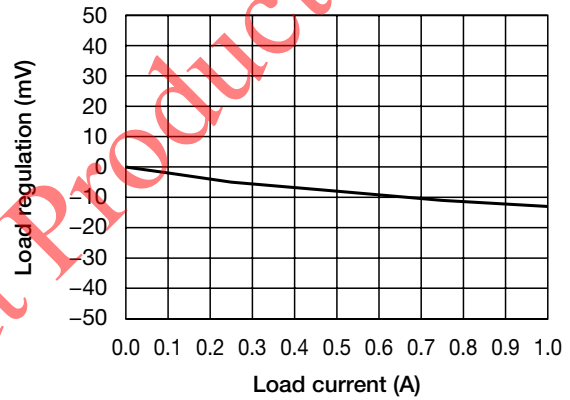

■ Input voltage - Input current

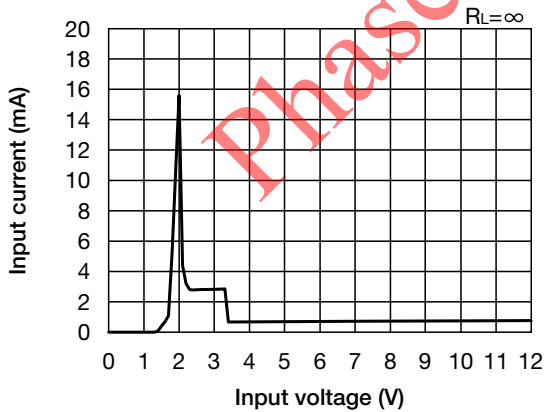

■ Dropout voltage

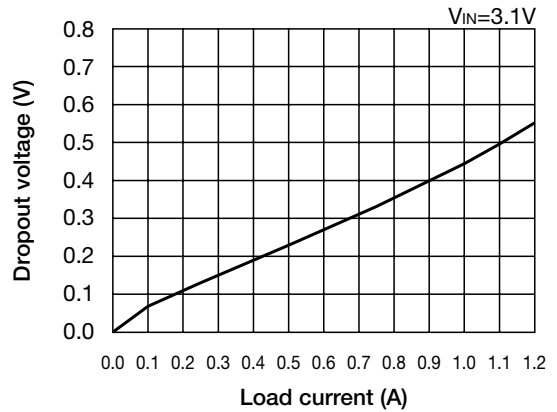

Output voltage - Temperature

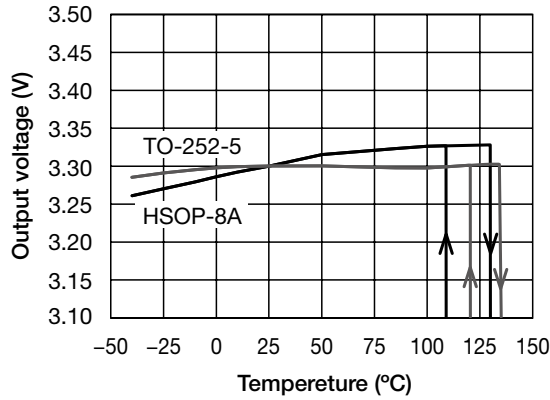

Output rise time

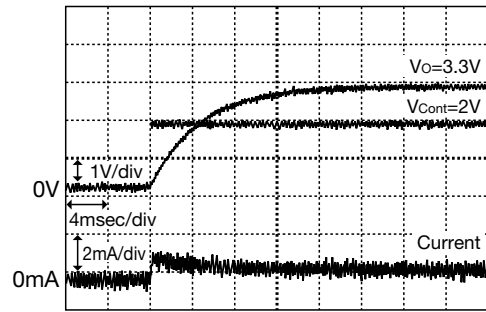

Rush current peak level

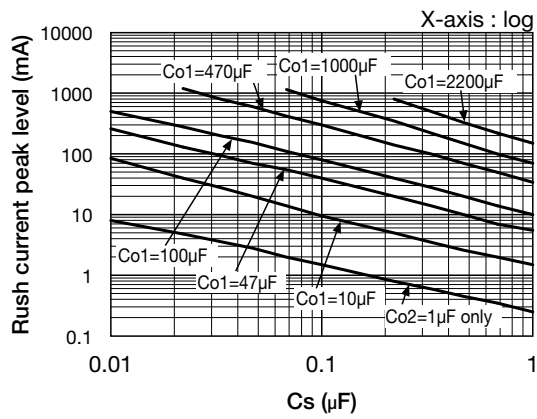

* Please refer to NOTE 7,8.

Rush current peak level

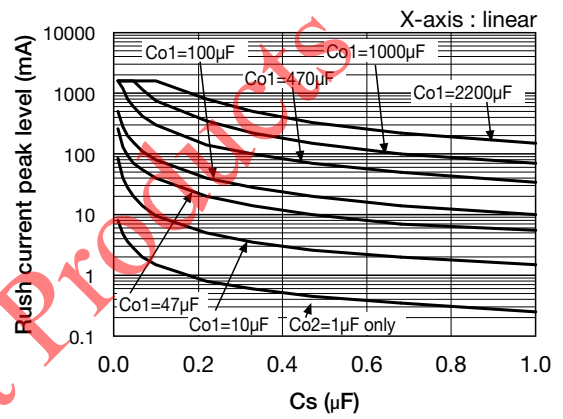

* Please refer to NOTE 7,8.

Phased Out Product

Characteristics (Vo=5.1V) (Except where noted otherwise $V_{IN}=V_O+1V$, $V_{Cont}=V_{IN}$, $C_{in}=1.0\mu F$, $C_o=1.0\mu F$, $C_s=0.1\mu F$, $T_a=25^\circ C$)

Output - Input voltage

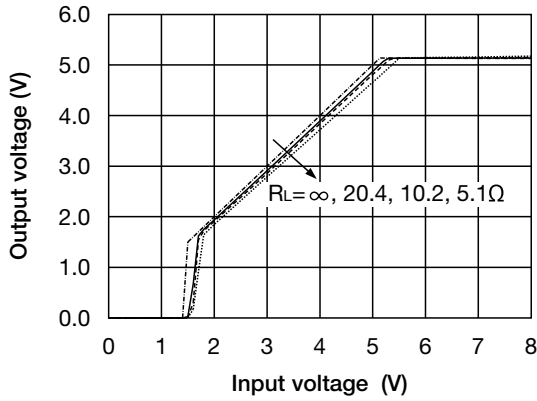

Line regulation

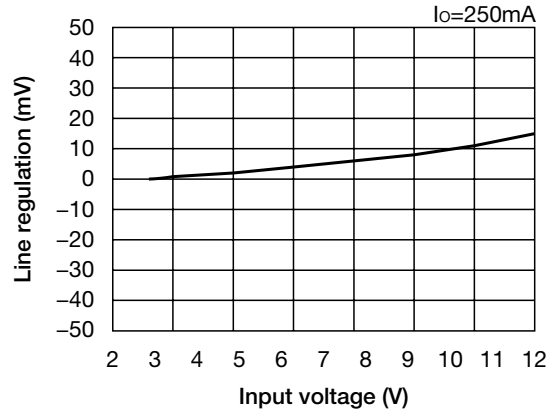

Load current - Output voltage

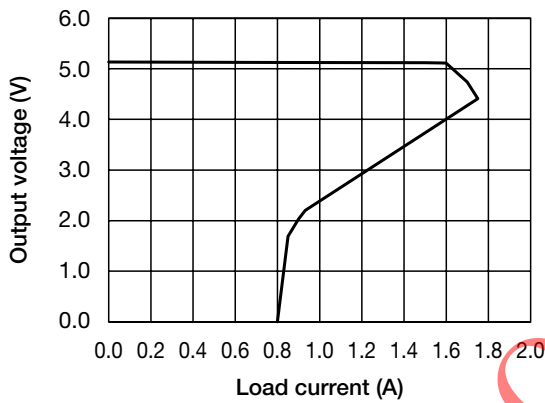

Load regulation

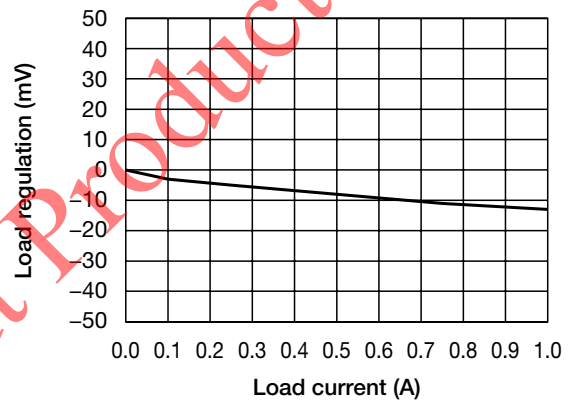

Input voltage - Input current

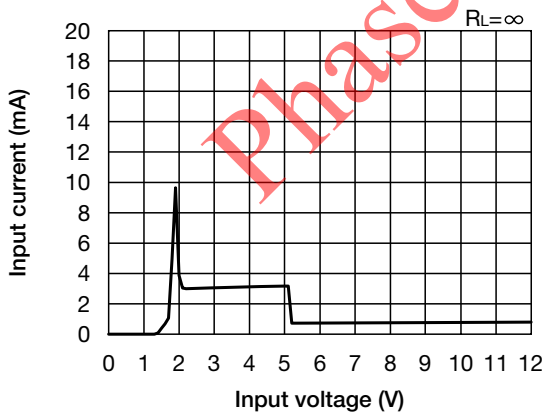

Dropout voltage

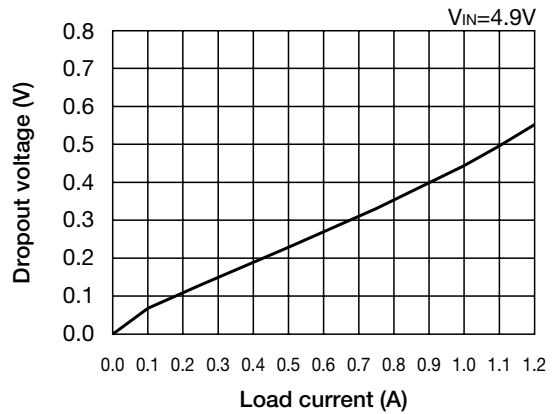

Output voltage - Temperature

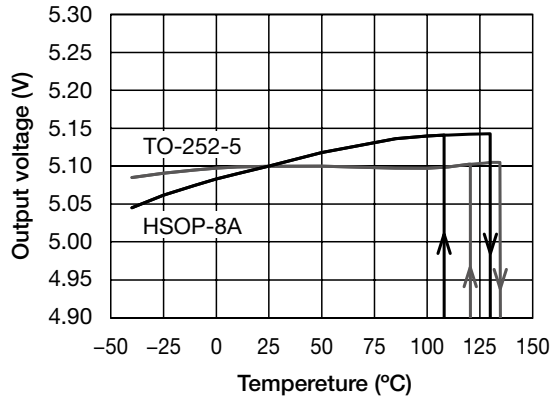

Output rise time

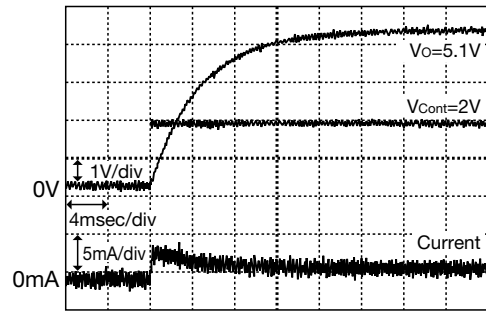

Rush current peak level

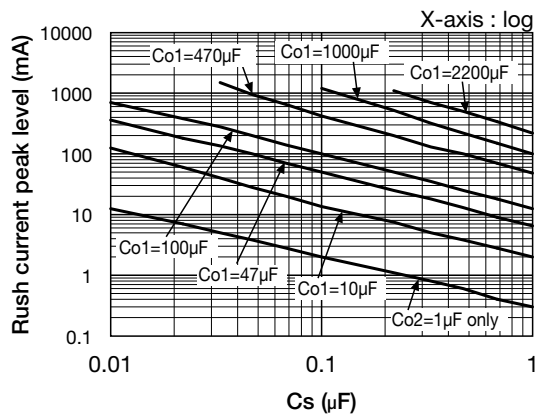

* Please refer to NOTE 7,8.

Rush current peak level

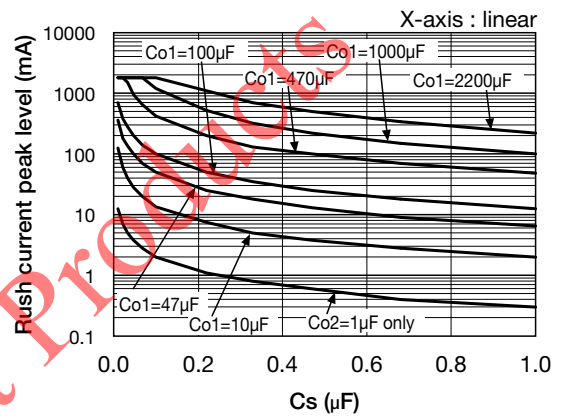

* Please refer to NOTE 7,8.

Phased Out Product

Characteristics (Except where noted otherwise $V_{IN}=V_O+1V$, $V_{Cont}=V_{IN}$, $C_{in}=1.0\mu F$, $C_O=1.0\mu F$, $C_s=0.1\mu F$, $T_a=25^\circ C$)

Ripple Rejection

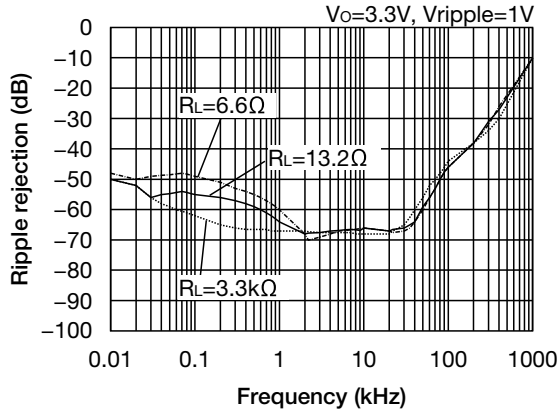

Ripple Rejection

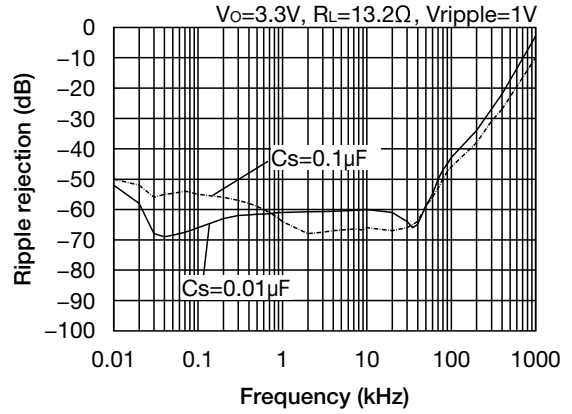

Output rise time

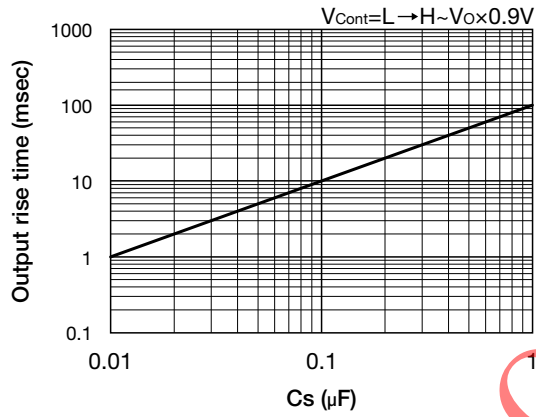

Load regulation

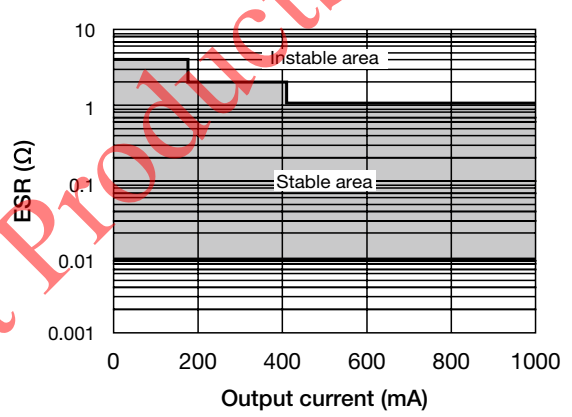

Phased Out Products