

**ADVANCED
POWER
TECHNOLOGY** T-39-15

APT1002RAN	1000V	6.0A	2.00 Ω
APT902RAN	900V	6.0A	2.00 Ω
APT1002R4AN	1000V	5.5A	2.40 Ω
APT902R4AN	900V	5.5A	2.40 Ω

POWER MOS IV™

N - CHANNEL ENHANCEMENT MODE HIGH VOLTAGE POWER MOSFETS

MAXIMUM RATINGS

All Ratings: $T_C = 25^\circ\text{C}$ unless otherwise specified.

Symbol	Parameter	APT				UNIT
		902RAN	1002RAN	902R4AN	1002R4AN	
V_{DSS}	Drain-Source Voltage	900	1000	900	1000	Volts
I_D	Continuous Drain Current	6.0		5.5		Amps
I_{DM}	Pulsed Drain Current ¹	24		22		Amps
V_{GS}	Gate-Source Voltage	±30				Volts
P_D	Total Power Dissipation @ $T_C = 25^\circ\text{C}$, Derate Above 25°C	198				Watts
T_J, T_{STG}	Operating and Storage Junction Temperature Range	- 55 to 150				$^\circ\text{C}$

STATIC ELECTRICAL CHARACTERISTICS

Symbol	Characteristic / Test Conditions / Part Number	MIN	TYP	MAX	UNIT
BV_{DSS}	Drain-Source Breakdown Voltage ($V_{GS} = 0V, I_D = 250 \mu\text{A}$)	APT1002RAN / APT1002R4AN		1000	Volts
		APT902RAN / APT902R4AN		900	Volts
I_{DSS}	Zero Gate Voltage Drain Current ($V_{DS} = V_{DSS}, V_{GS} = 0V$) ($V_{DS} = 0.8 V_{DSS}, V_{GS} = 0V, T_C = 125^\circ\text{C}$)			250	μA
				1000	
I_{GSS}	Gate-Source Leakage Current ($V_{GS} = \pm 30V, V_{DS} = 0V$)			±100	nA
$I_{D(ON)}$	On State Drain Current ² ($V_{DS} > I_{D(ON)} \times R_{DS(ON)} \text{ Max}, V_{GS} = 10V$)	APT1002RAN / APT902RAN		6.0	Amps
		APT1002R4AN / APT902R4AN		5.5	Amps
$V_{GS(TH)}$	Gate Threshold Voltage ($V_{DS} = V_{GS}, I_D = 1\text{mA}$)	2		4	Volts
$R_{DS(ON)}$	Static Drain-Source On-State Resistance ² ($V_{GS} = 10V, I_D = 0.5 I_D [\text{Cont.}]$)	APT1002RAN / APT902RAN		2.00	Ohms
		APT1002R4AN / APT902R4AN		2.40	Ohms

THERMAL CHARACTERISTICS

Symbol	Characteristic	MIN	TYP	MAX	UNIT
$R_{\theta JC}$	Junction to Case			0.63	$^\circ\text{C/W}$
$R_{\theta JA}$	Junction to Ambient			30	$^\circ\text{C/W}$
T_L	Max. Lead Temp. for Soldering Conditions: 0.063" from Case for 10 Sec.			300	$^\circ\text{C}$

405 S.W. COLUMBIA STREET
BEND, OREGON 97702-1035
U.S.A.

PHONE ... (503) 382-8028

FAX (503) 388-0364

Symbol	Characteristic	Test Conditions	MIN	TYP	MAX	UNIT
C_{iss}	Input Capacitance	$V_{GS} = 0V$ $V_{DS} = 25V$ $f = 1\text{ MHz}$		1530	1800	pF
C_{oss}	Output Capacitance			230	325	pF
C_{rss}	Reverse Transfer Capacitance			80	120	pF
Q_g	Total Gate Charge ³	$V_{GS} = 10V, I_D = I_D [\text{Cont.}]$ $V_{DD} = 0.5 V_{DSS}$		66	105	nC
Q_{gs}	Gate-Source Charge			6.5	10	nC
Q_{gd}	Gate-Drain ("Miller") Charge			36	54	nC
$t_d(\text{on})$	Turn-on Delay Time	$V_{DD} = 0.5 V_{DSS}$ $I_D = I_D [\text{Cont.}], V_{GS} = 15V$ $R_G = 1.8\Omega$		14	28	ns
t_r	Rise Time			13	26	ns
$t_d(\text{off})$	Turn-off Delay Time			55	82	ns
t_f	Fall Time			19	37	ns

SOURCE-DRAIN DIODE RATINGS AND CHARACTERISTICS

Symbol	Characteristic / Test Conditions / Part Number	MIN	TYP	MAX	UNIT
I_S	Continuous Source Current (Body Diode)	APT1002RAN / APT902RAN		6.0	Amps
		APT1002R4AN / APT902R4AN		5.5	Amps
I_{SM}	Pulsed Source Current ¹ (Body Diode)	APT1002RAN / APT902RAN		24	Amps
		APT1002R4AN / APT902R4AN		22	Amps
V_{SD}	Diode Forward Voltage ² ($V_{GS} = 0V, I_S = -I_D [\text{Cont.}]$)			1.3	Volts
t_{rr}	Reverse Recovery Time ($I_S = -I_D [\text{Cont.}], di_S/dt = 100A/\mu s$)	225	450	910	ns
Q_{rr}	Reverse Recovery Charge	1.2	2.5	5	μC

SAFE OPERATING AREA CHARACTERISTICS

Symbol	Characteristic	Test Conditions / Part Number	MIN	TYP	MAX	UNIT
SOA1	Safe Operating Area	$V_{DS} = 0.4 V_{DSS}, I_{DS} = P_D / 0.4 V_{DSS}, t = 1\text{ Sec.}$	198			Watts
SOA2	Safe Operating Area	$I_{DS} = I_D [\text{Cont.}], V_{DS} = P_D / I_D [\text{Cont.}], t = 1\text{ Sec.}$	198			Watts
I_{LM}	Inductive Current Clamped	APT1002RAN / APT902RAN	24			Amps
		APT1002R4AN / APT902R4AN	22			Amps

1.) Repetitive Rating: Pulse width limited by maximum junction temperature. See Transient Thermal Impedance Curve. (Fig.1)

2.) Pulse Test: Pulse width < 380 μs
Duty Cycle < 2%
3.) See MIL-STD-750 Method 3471

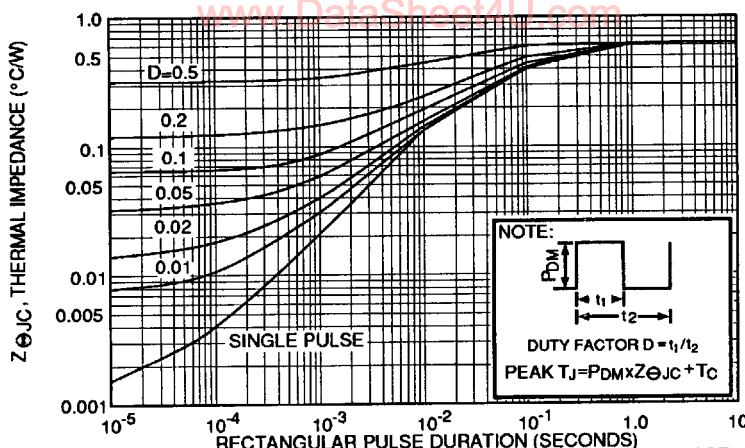

FIGURE 1, MAXIMUM EFFECTIVE TRANSIENT THERMAL IMPEDANCE, JUNCTION-TO-CASE vs PULSE DURATION

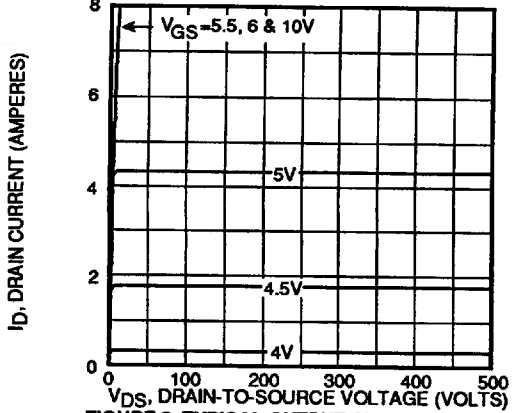

FIGURE 2, TYPICAL OUTPUT CHARACTERISTICS

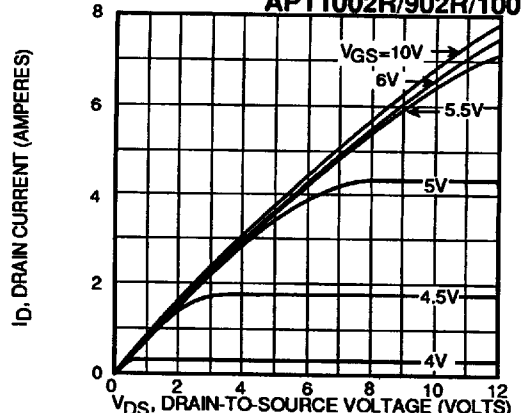

FIGURE 3, TYPICAL OUTPUT CHARACTERISTICS

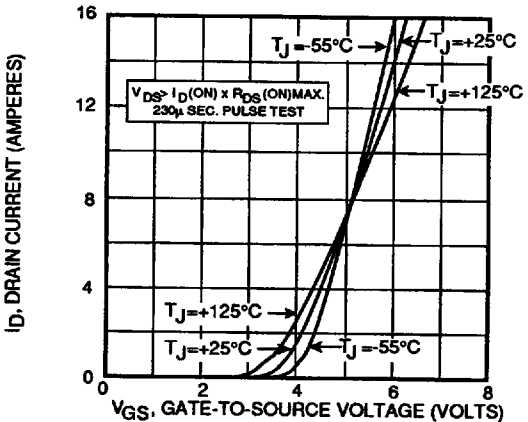

FIGURE 4, TYPICAL TRANSFER CHARACTERISTICS

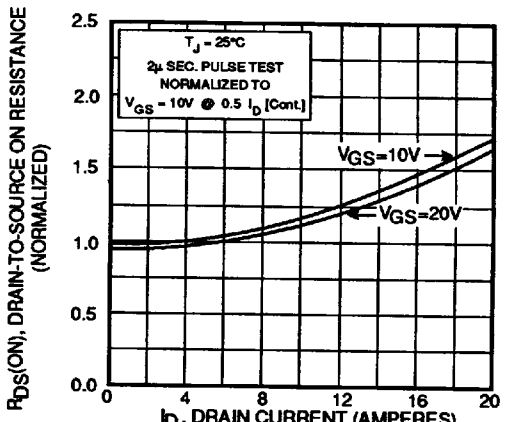

FIGURE 5, $R_{DS(ON)}$ vs DRAIN CURRENT

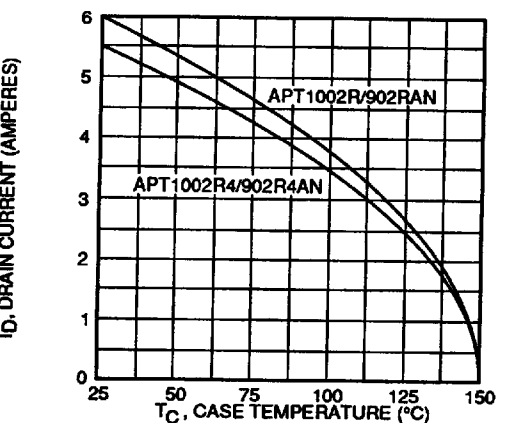

FIGURE 6, MAXIMUM DRAIN CURRENT vs CASE TEMPERATURE

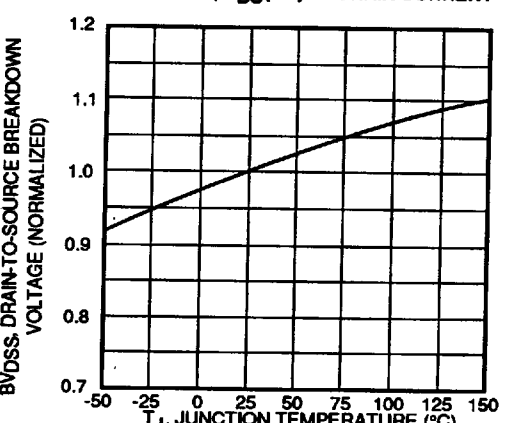

FIGURE 7, BREAKDOWN VOLTAGE vs TEMPERATURE

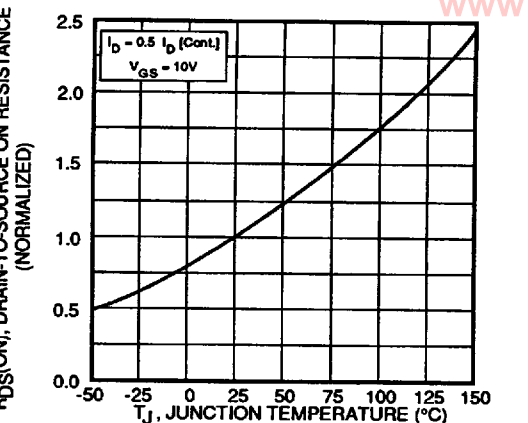

FIGURE 8, ON-RESISTANCE vs. TEMPERATURE

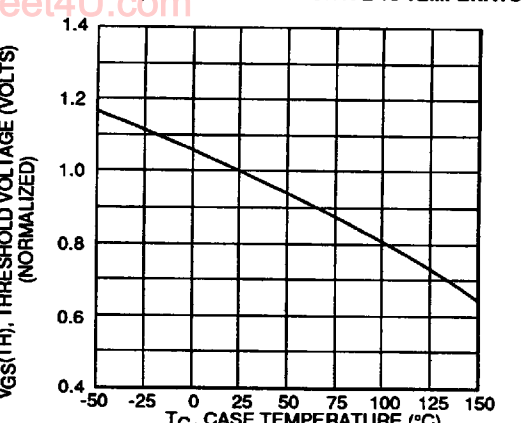

FIGURE 9, THRESHOLD VOLTAGE vs TEMPERATURE

T-39-15

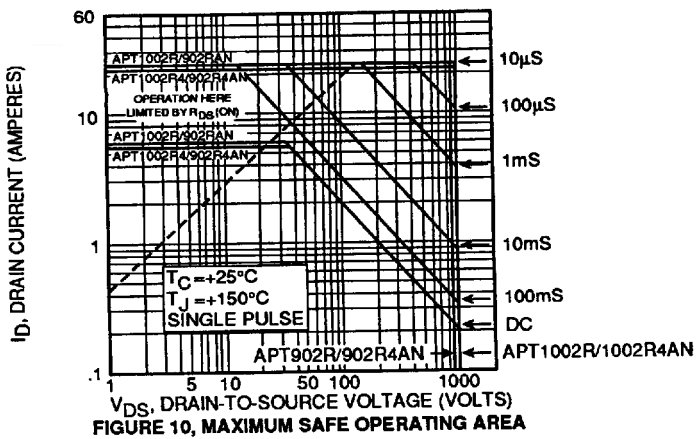

FIGURE 10, MAXIMUM SAFE OPERATING AREA

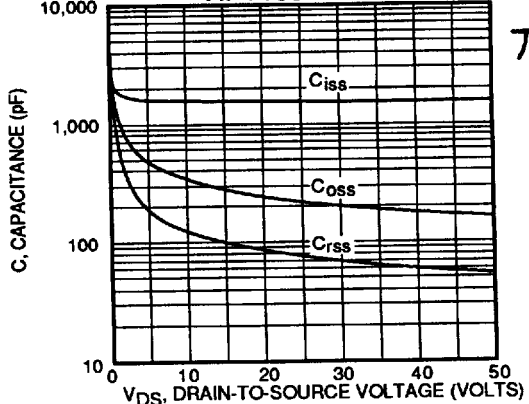

FIGURE 11, TYPICAL CAPACITANCE vs DRAIN-TO-SOURCE VOLTAGE

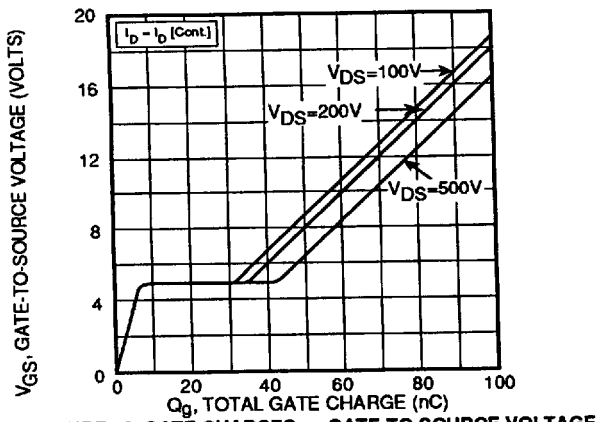

FIGURE 12, GATE CHARGES vs GATE-TO-SOURCE VOLTAGE

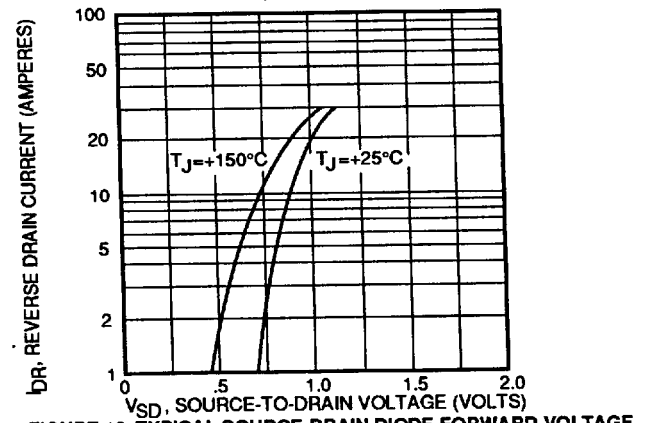
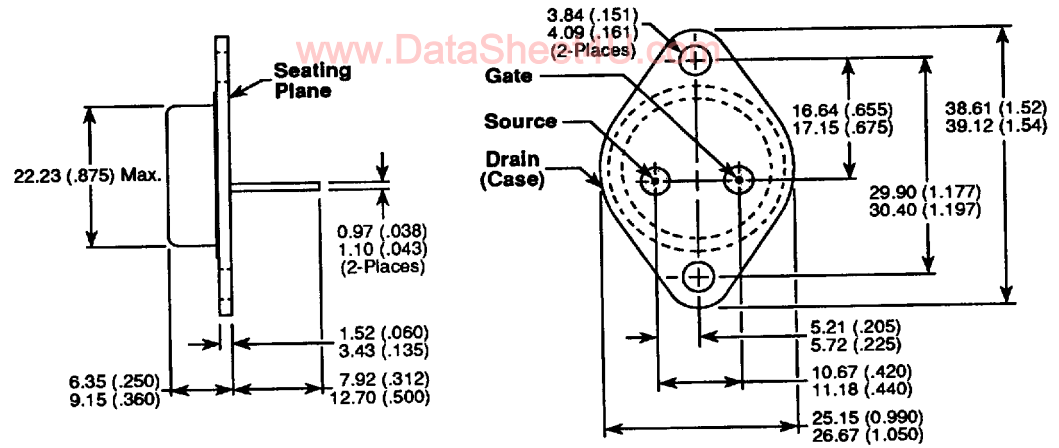

FIGURE 13, TYPICAL SOURCE-DRAIN DIODE FORWARD VOLTAGE

TO-3 Package Outline (TO-204AA)



Dimensions in Millimeters and (Inches)