

■Features

- High Luminous PLCC2 Top SMD LEDs
- 3.5x2.8x1.9mm Standard Directivity
- Long Lifetime Operation
- Superior Weather-resistance
- Red Diffused Type

■Applications

- Backlighting (switches, keys, displays, illuminated advertising etc.)
- Substitution of Micro Incandescent Lamps
- Reading Lamps / Emergency Lighting
- Marker lights (e.g. steps, exit ways, etc.)
- Other Lighting

■Outline Dimension

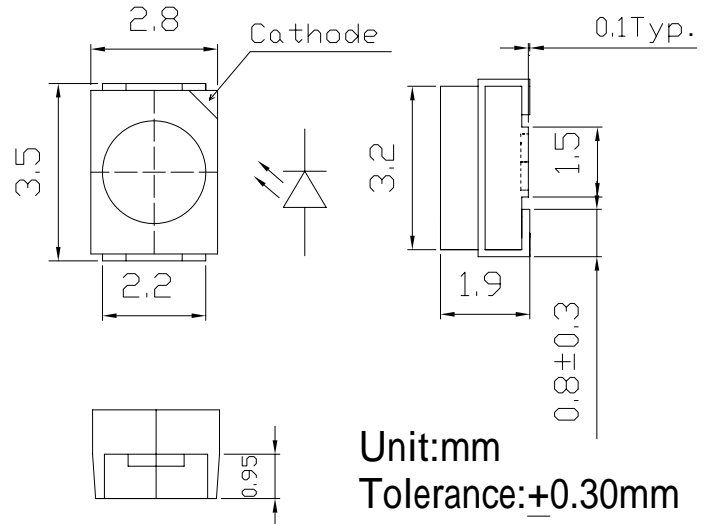

■Absolute Maximum Rating

(Ta=25)

Item	Symbol	Value	Unit
DC Forward Current	I_F	30	mA
Pulse Forward Current*	I_{FP}	100	mA
Reverse Voltage	V_R	5	V
Power Dissipation	P_D	108	mW
Operating Temperature	T_{opr}	-30 ~ +85	
Storage Temperature	T_{stg}	-40 ~ +100	
Lead Soldering Temperature	T_{sol}	260 /5sec	-

*Pulse width Max.10ms Duty ratio max 1/10

■Directivity

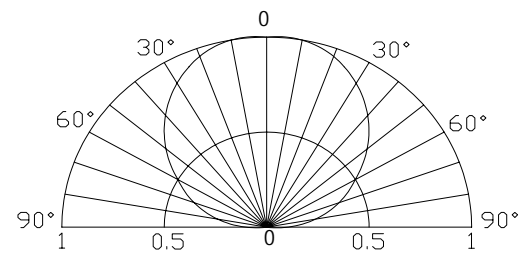

Electrical -Optical Characteristics

(Ta=25)

Item	Symbol	Condition	Min.	Typ.	Max.	Unit
DC Forward Voltage	V_F	$I_F=20mA$	2.8	3.1	3.6	V
DC Reverse Current	I_R	$V_R=5V$	-	-	10	μA
Luminous Flux	v	$I_F=20mA$	4.0	4.4	-	lm
Chromaticity Coordinates*	x	$I_F=20mA$	-	0.55	-	
	y	$I_F=20mA$	-	0.36	-	
50% Power Angle	$2\theta_{1/2}$	$I_F=20mA$	-	120	-	deg

*1 Luminous Flux Measurement allowance is $\pm 15\%$

*2 Chromaticity Coordinates Measurement allowance is $\pm 10\%$