

FEATURES

- Ultra Low Loss
- High Ruggedness
- High Short Circuit Capability
- Positive Temperature Coefficient
- Integrated Gate Resistor

APPLICATIONS

- Invertor
- Converter
- Welder
- SMPS and UPS
- Induction Heating



ABSOLUTE MAXIMUM RATINGS

$T_C=25^{\circ}\text{C}$ unless otherwise specified

Symbol	Parameter	Test Conditions	Values	Unit
IGBT				
V_{CES}	Collector - Emitter Voltage		600	V
V_{GES}	Gate - Emitter Voltage		± 20	V
I_C	DC Collector Current	$T_C=25^{\circ}\text{C}$	460	A
		$T_C=50^{\circ}\text{C}$	400	A
I_{Cpuls}	Pulsed Collector Current	$T_C=25^{\circ}\text{C}, t_p=1\text{ms}$	920	A
		$T_C=50^{\circ}\text{C}, t_p=1\text{ms}$	800	A
P_{tot}	Power Dissipation Per IGBT		1400	W
T_J	Junction Temperature Range		-40 to +150	$^{\circ}\text{C}$
T_{STG}	Storage Temperature Range		-40 to +125	$^{\circ}\text{C}$
V_{isol}	Insulation Test Voltage	AC, $t=1\text{min}$	3000	V
Free-Wheeling Diode				
V_{RRM}	Repetitive Reverse Voltage		600	V
$I_{F(AV)}$	Average Forward Current	$T_C=25^{\circ}\text{C}$	400	A
		$T_C=50^{\circ}\text{C}$	320	A
$I_{F(RMS)}$	RMS Forward Current		570	A
I_{FSM}	Non-Repetitive Surge	$T_J=45^{\circ}\text{C}, t=10\text{ms}, \text{Sine}$	1200	A
	Forward Current	$T_J=45^{\circ}\text{C}, t=8.3\text{ms}, \text{Sine}$	1320	A

MIMMG400D060B6N

ELECTRICAL CHARACTERISTICS

T_C=25°C unless otherwise specified

Symbol	Parameter	Test Conditions	Min.	Typ.	Max.	Unit
IGBT						
V _{GE(th)}	Gate - Emitter Threshold Voltage	V _{CE} =V _{GE} , I _C =8mA	4.5	5.5	6.5	V
V _{CE(sat)}	Collector - Emitter Saturation Voltage	I _C =400A, V _{GE} =15V, T _J =25°C		1.95	2.45	V
		I _C =400A, V _{GE} =15V, T _J =125°C		2.2		V
I _{CES}	Collector Leakage Current	V _{CE} =600V, V _{GE} =0V, T _J =25°C			1	mA
		V _{CE} =600V, V _{GE} =0V, T _J =125°C		2		mA
I _{GES}	Gate Leakage Current	V _{CE} =0V, V _{GE} =±20V	-1.2		1.2	μA
R _{Gint}	Integrated Gate Resistor			2.5	3.5	Ω
Q _{ge}	Gate Charge	V _{CC} =300V, I _C =400A, V _{GE} =±15V		1780		nC
C _{ies}	Input Capacitance	V _{CE} =25V, V _{GE} =0V, f=1MHz		18		nF
C _{oes}	Output Capacitance			1.8		nF
C _{res}	Reverse Transfer Capacitance			1.6		nF
t _{d(on)}	Turn - on Delay Time	V _{CC} =300V, I _C =400A		195		ns
t _r	Rise Time	R _G =3 Ω, V _{GE} =±15V		65		ns
t _{d(off)}	Turn - off Delay Time	T _J =25°C		295		ns
t _f	Fall Time	Inductive Load		45		ns
t _{d(on)}	Turn - on Delay Time	V _{CC} =300V, I _C =400A		220		ns
t _r	Rise Time	R _G =3 Ω, V _{GE} =±15V		80		ns
t _{d(off)}	Turn - off Delay Time	T _J =125°C		350		ns
t _f	Fall Time	Inductive Load		60		ns
E _{on}	Turn - on Switching Energy	V _{CC} =300V, I _C =400A, T _J =25°C		6.5		mJ
		R _G =3 Ω, T _J =125°C		10		mJ
E _{off}	Turn - off Switching Energy	V _{GE} =±15V, T _J =25°C		9.5		mJ
		Inductive Load, T _J =125°C		14.5		mJ
Free-Wheeling Diode						
V _F	Forward Voltage	I _F =400A, V _{GE} =0V, T _J =25°C		1.25	1.6	V
		I _F =400A, V _{GE} =0V, T _J =125°C		1.2		V
t _{rr}	Reverse Recovery Time	I _F =400A, V _R =300V		249		ns
I _{RRM}	Max. Reverse Recovery Current	di _F /dt=-2000A/μs		214		A
Q _{rr}	Reverse Recovery Charge	T _J =125°C		31		μC

THERMAL AND MECHANICAL CHARACTERISTICS

Symbol	Parameter	Test Conditions	Min.	Typ.	Max.	Unit
R _{thJC}	Junction-to-Case Thermal Resistance	Per IGBT			0.09	K/W
R _{thJCD}	Junction-to-Case Thermal Resistance	Per Inverse Diode			0.15	K/W
Torque	Module-to-Sink	Recommended (M6)	3		5	N·m
Torque	Module Electrodes	Recommended (M6)	2.5		5	N·m
Weight				310		g

MIMMG400D060B6N

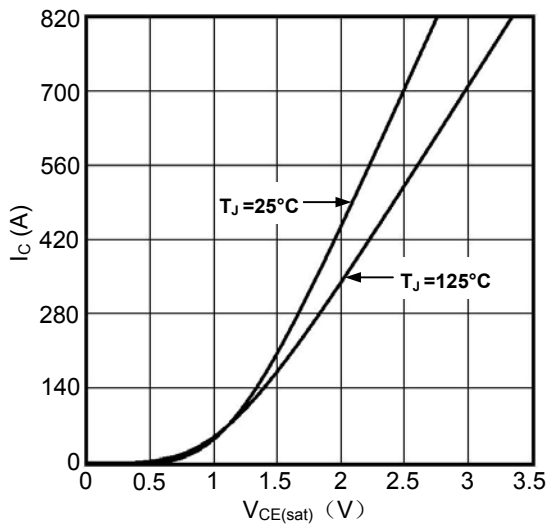

Figure1. Typical Output characteristics

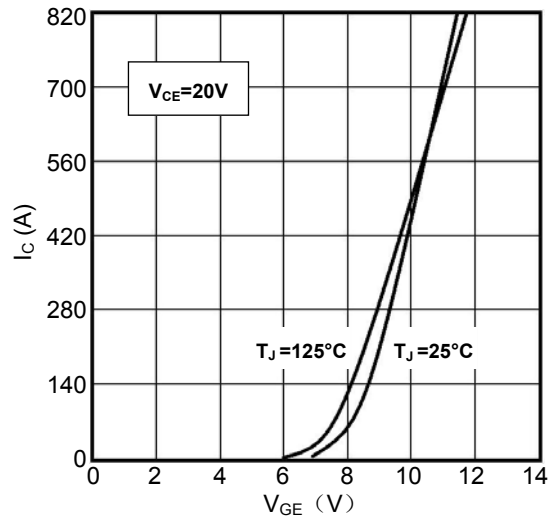

Figure2. Typical Transfer characteristics

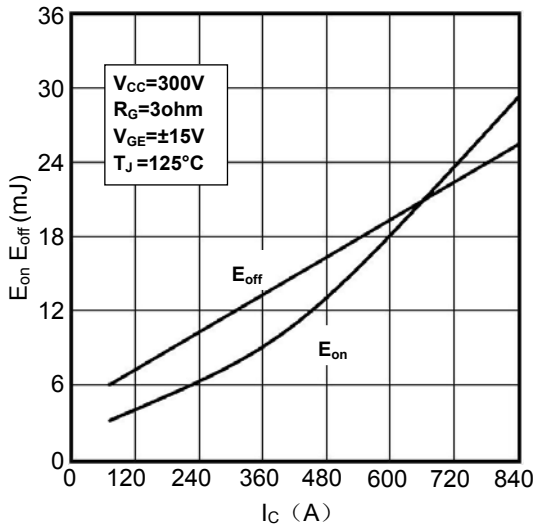

Figure3. Switching Energy vs. Collector Current

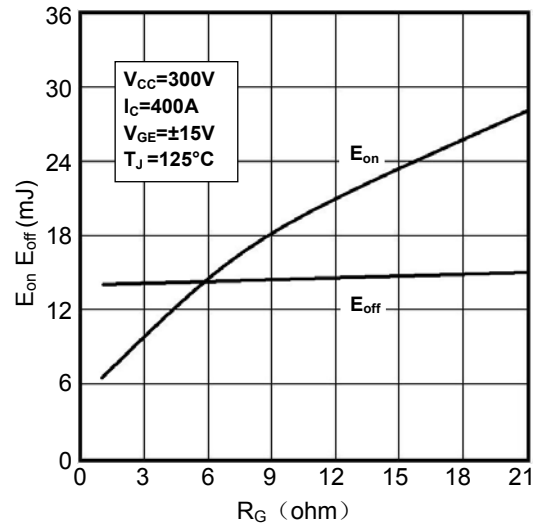

Figure4. Switching Energy vs. Gate Resistor

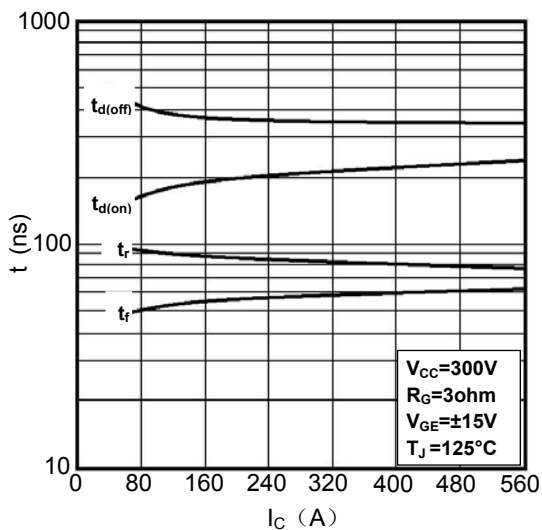

Figure5. Switching Times vs. Collector Current

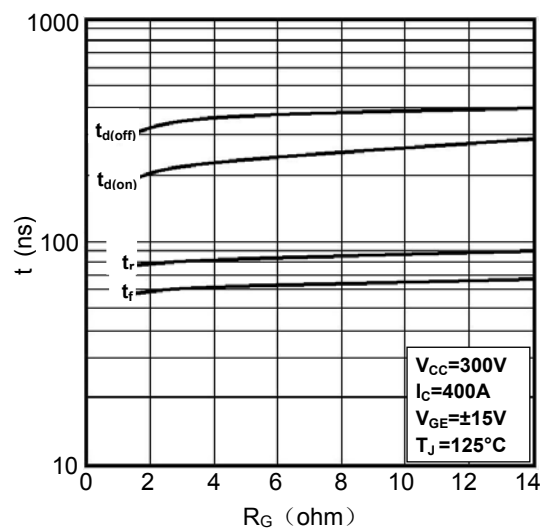

Figure6. Switching Times vs. Gate Resistor

MIMMG400D060B6N

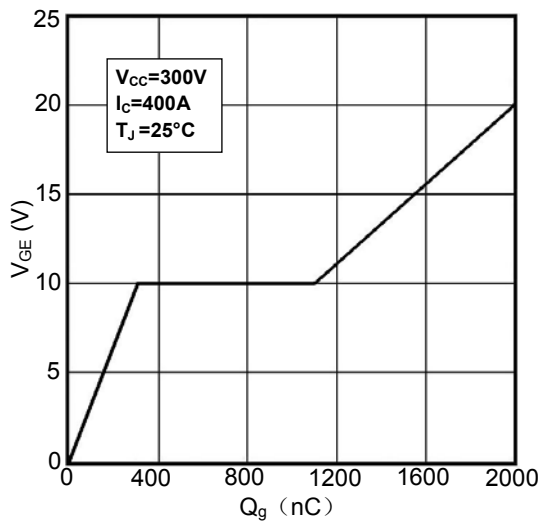

Figure7. Gate Charge characteristics

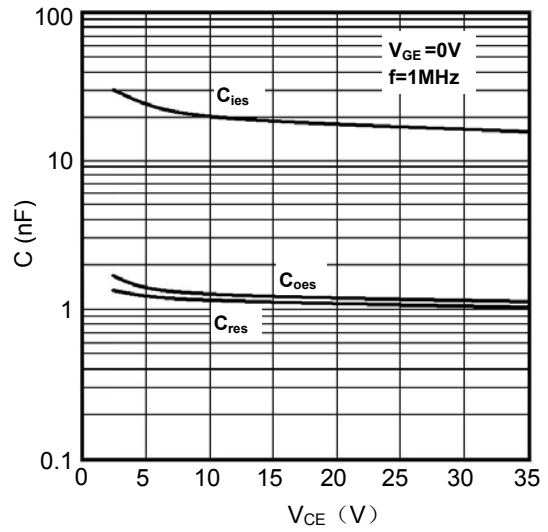

Figure8. Typical Capacitances vs. V_{CE}

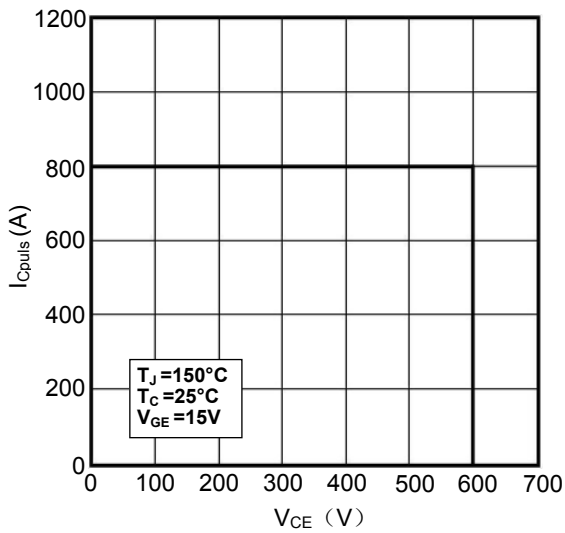

Figure9. Reverse Biased Safe Operating Area

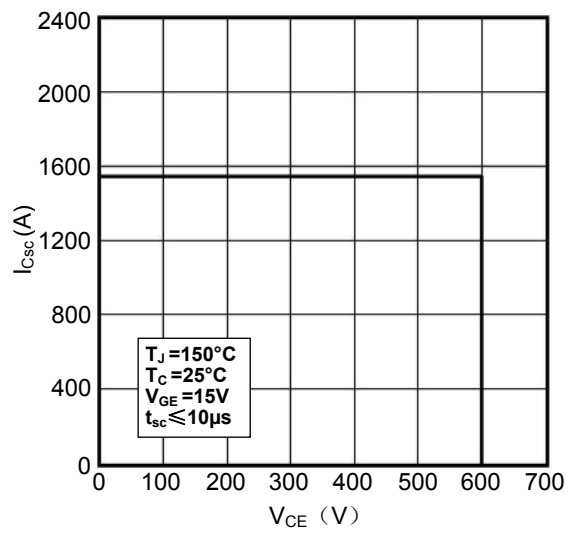

Figure10. Short Circuit Safe Operating Area

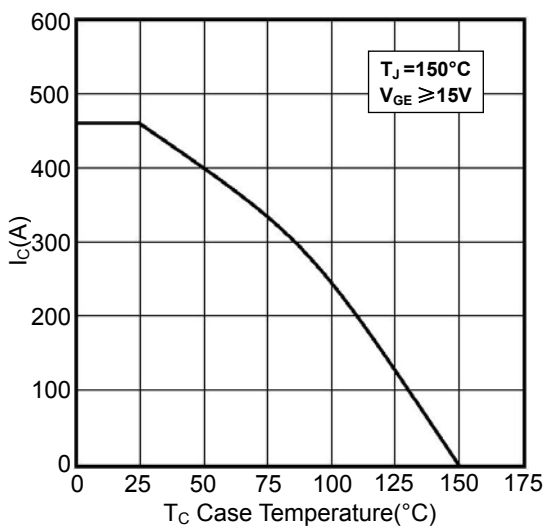

Figure11. Rated Current vs. T_C

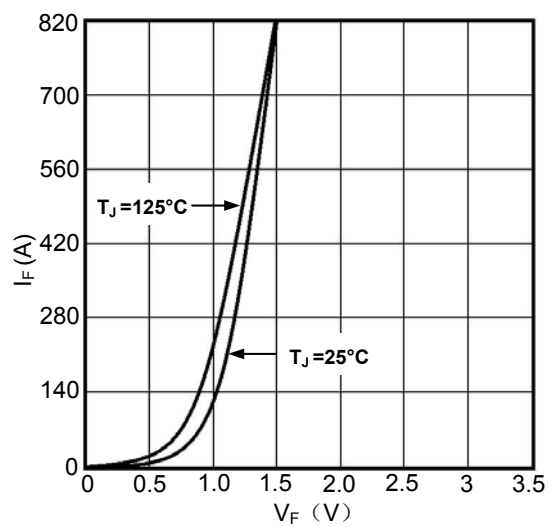

Figure12. Diode Forward Characteristics

MIMMG400D060B6N

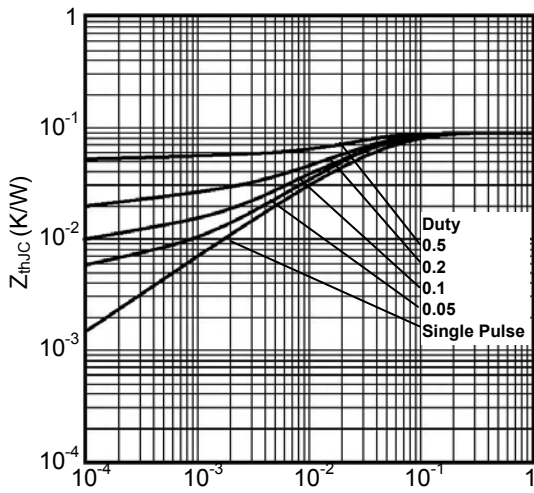

Figure13. Transient Thermal Impedance of IGBT

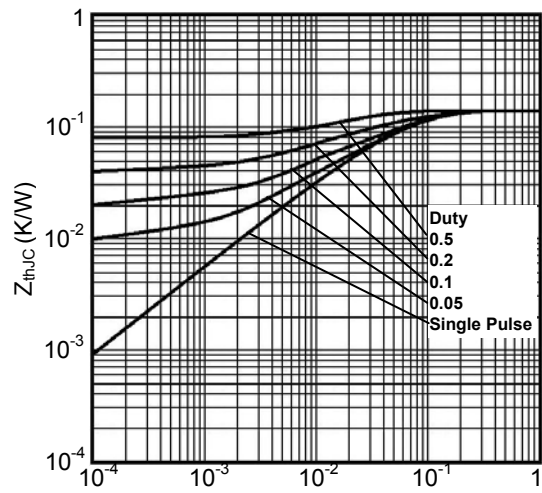

Figure14. Transient Thermal Impedance of Diode

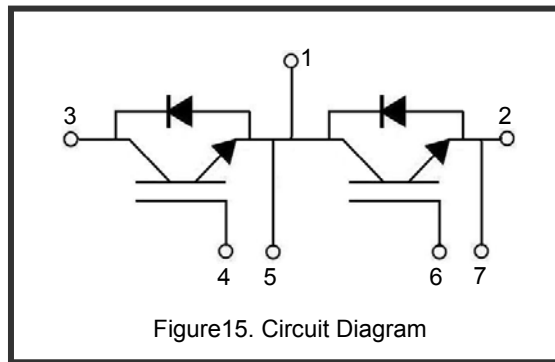

Figure15. Circuit Diagram

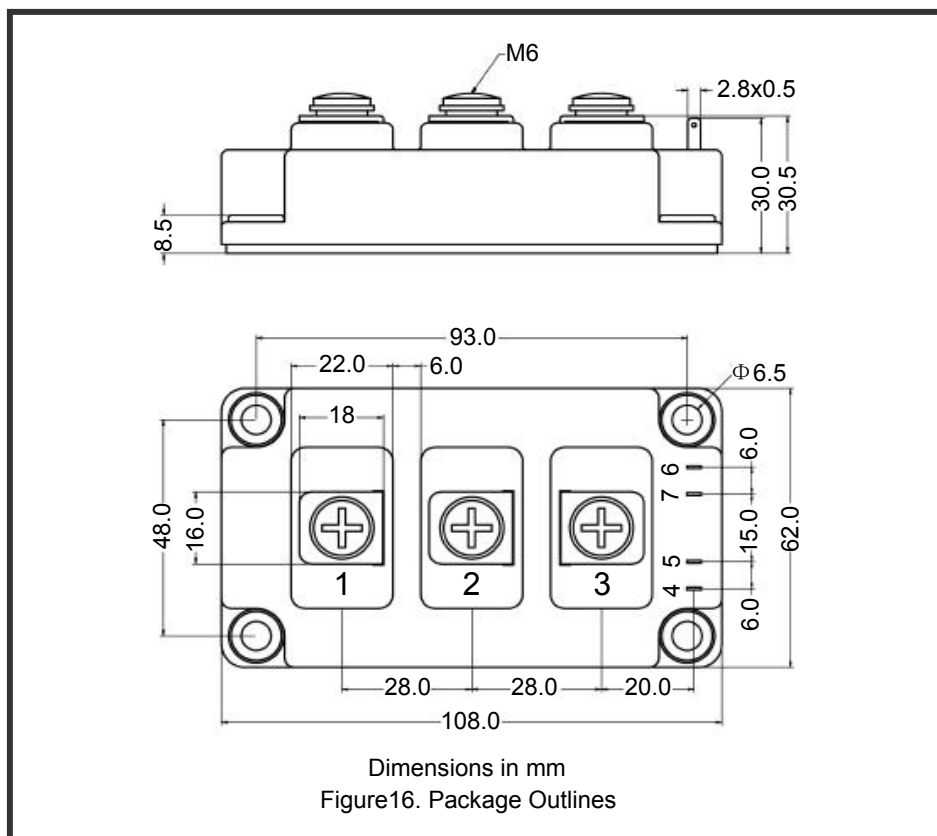

Figure16. Package Outlines