

PRODUCT FEATURES

- Ultrafast Reverse Recovery Time
- Soft Reverse Recovery Characteristics
- Low Reverse Recovery Loss
- Low Forward Voltage
- High Surge Current Capability
- Low Inductance Package



APPLICATIONS

- Inversion Welder
- Uninterruptible Power Supply (UPS)
- Plating Power Supply
- Ultrasonic Cleaner and Welder
- Converter & Chopper
- Power Factor Correction (PFC) Circuit

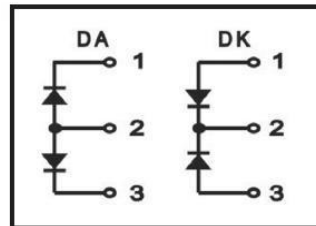

ABSOLUTE MAXIMUM RATINGS

$T_C=25^{\circ}\text{C}$ unless otherwise specified

| Symbol | Parameter | Test Conditions | Values | Unit |
|-----------------|--------------------------------------|--|-------------|-----------------------------|
| V_R | Maximum D.C. Reverse Voltage | | 1200 | V |
| V_{RRM} | Maximum Repetitive Reverse Voltage | | 1200 | V |
| $I_{F(AV)}$ | Average Forward Current | $T_C=75^{\circ}\text{C}$, Per Diode | 100 | A |
| | | $T_C=75^{\circ}\text{C}$, Per Moudle | 200 | A |
| | | $T_C=85^{\circ}\text{C}$, 20KHz, Per Moudle | 150 | A |
| $I_{F(RMS)}$ | RMS Forward Current | $T_C=75^{\circ}\text{C}$, Per Diode | 150 | A |
| I_{FSM} | Non-Repetitive Surge Forward Current | $T_J=45^{\circ}\text{C}$, $t=10\text{ms}$, 50Hz, Sine | 1100 | A |
| | | $T_J=45^{\circ}\text{C}$, $t=8.3\text{ms}$, 60Hz, Sine | 1200 | A |
| I^2t | I^2t (For Fusing) | $T_J=45^{\circ}\text{C}$, $t=10\text{ms}$, 50Hz, Sine | 6050 | A^2s |
| | | $T_J=45^{\circ}\text{C}$, $t=8.3\text{ms}$, 60Hz, Sine | 7200 | A^2s |
| P_D | Power Dissipation | | 280 | W |
| T_J | Junction Temperature | | -40 to +150 | $^{\circ}\text{C}$ |
| T_{STG} | Storage Temperature Range | | -40 to +125 | $^{\circ}\text{C}$ |
| V_{ISOL} | Insulation Test Voltage | AC, $t=1\text{min}$ | 3000 | V |
| Torque | Module-to-Sink | Recommended (M5) | 2.5~4 | N·m |
| Torque | Module Electrodes | Recommended (M5) | 2.5~4 | N·m |
| $R_{\theta JC}$ | Thermal Resistance | Junction-to-Case | 0.44 | $^{\circ}\text{C}/\text{W}$ |
| Weight | | | 100 | g |

ELECTRICAL CHARACTERISTICS

$T_C=25^\circ\text{C}$ unless otherwise specified

| Symbol | Parameter | Test Conditions | Min. | Typ. | Max. | Unit |
|-----------|-------------------------------|---|---|------|------|------|
| I_{RM} | Reverse Leakage Current | $V_R=1200\text{V}$ | -- | -- | 1 | mA |
| | | $V_R=1200\text{V}, T_J=125^\circ\text{C}$ | -- | -- | 20 | mA |
| V_F | Forward Voltage | $I_F=100\text{A}$ | -- | -- | 1.77 | V |
| | | $I_F=100\text{A}, T_J=125^\circ\text{C}$ | -- | -- | 1.6 | V |
| t_{rr} | Reverse Recovery Time | $I_F=1\text{A}, V_R=30\text{V}, di_F/dt=-200\text{A}/\mu\text{s}$ | -- | 35 | -- | ns |
| t_{rr} | Reverse Recovery Time | $V_R=600\text{V}, I_F=100\text{A}$ | -- | 150 | -- | ns |
| I_{RRM} | Max. Reverse Recovery Current | | $di_F/dt=-200\text{A}/\mu\text{s}, T_J=25^\circ\text{C}$ | -- | 28 | -- |
| t_{rr} | Reverse Recovery Time | $V_R=600\text{V}, I_F=100\text{A}$ | -- | 250 | -- | ns |
| I_{RRM} | Max. Reverse Recovery Current | | $di_F/dt=-200\text{A}/\mu\text{s}, T_J=100^\circ\text{C}$ | -- | 47 | -- |

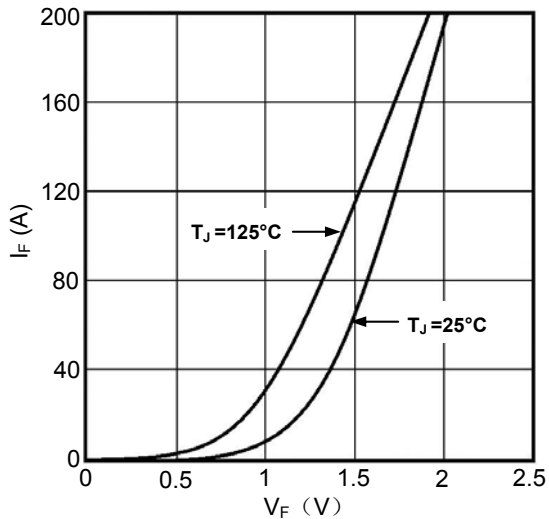

Figure1. Forward Voltage Drop vs Forward Current

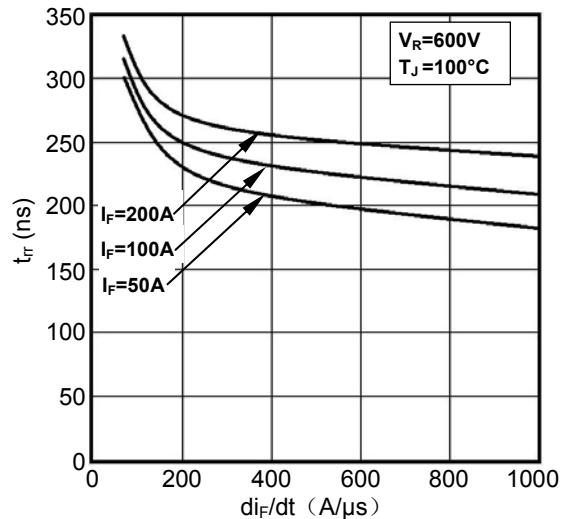

Figure2. Reverse Recovery Time vs di_F/dt

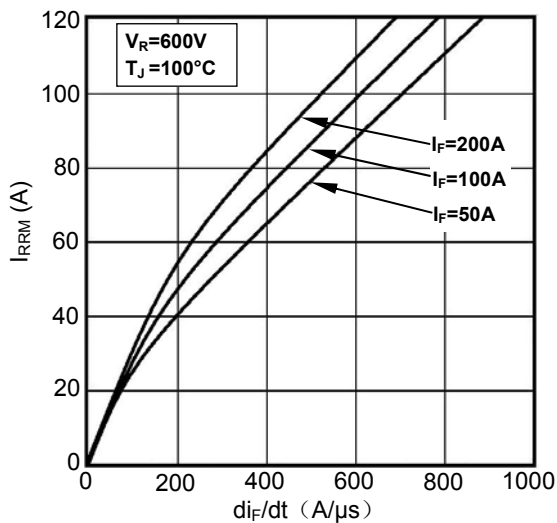

Figure3. Reverse Recovery Current vs di_F/dt

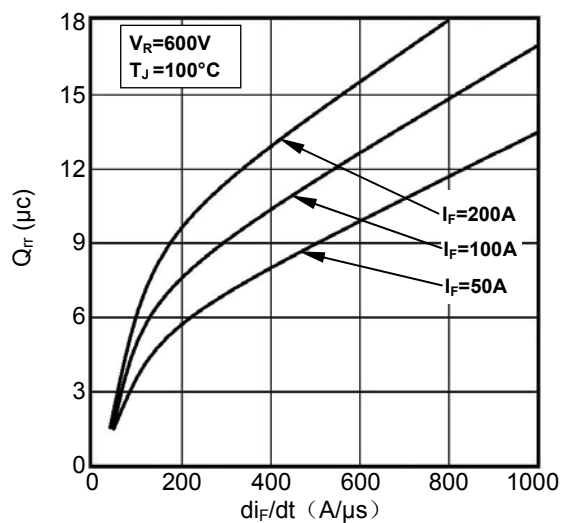

Figure4. Reverse Recovery Charge vs di_F/dt

MIMMF200N120DA
MIMMF200N120DK

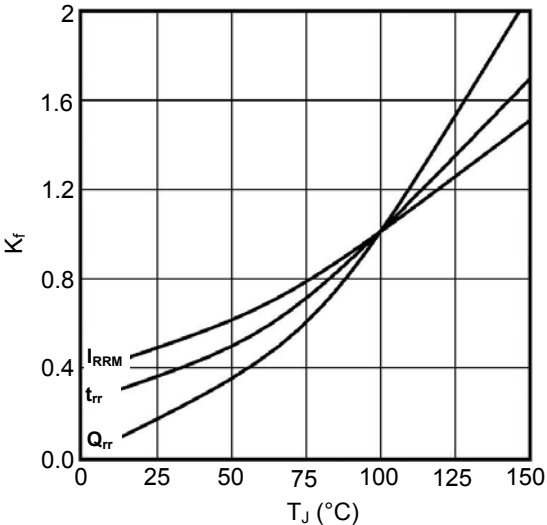

Figure5. Dynamic Parameters vs Junction Temperature

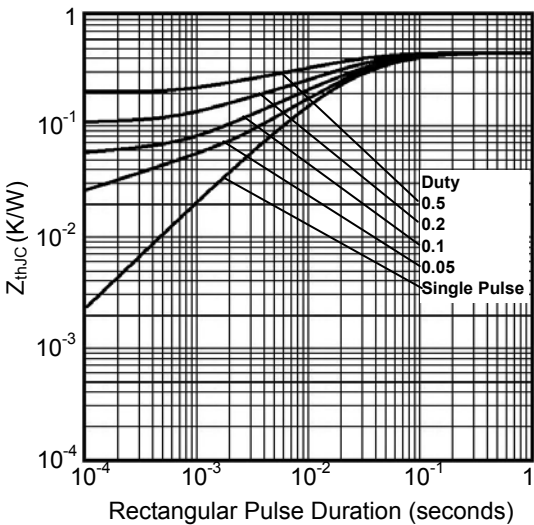
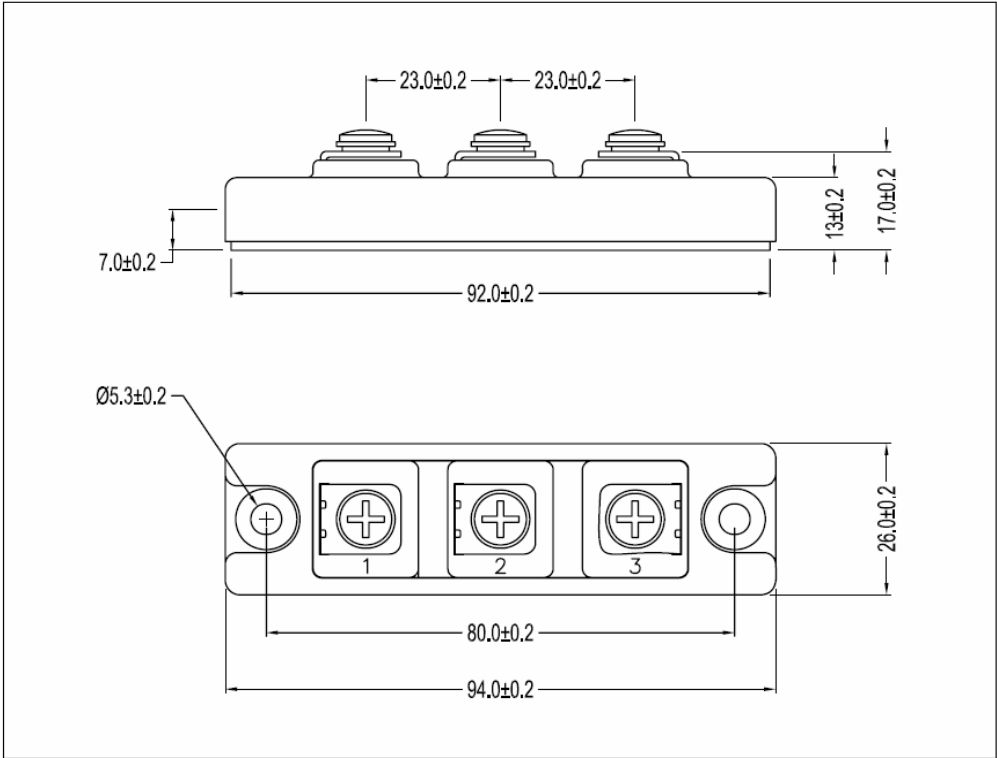

Figure6. Transient Thermal Impedance



Dimensions (mm)
 Figure7. Package Outline