

ISOMETRIC VIEW

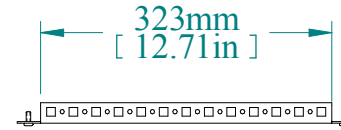

TOP VIEW

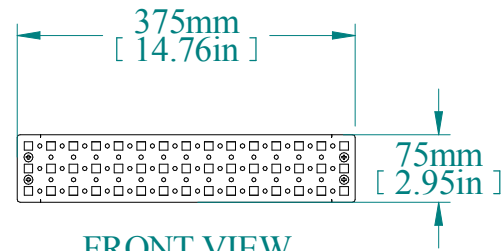

FRONT VIEW



A REAR VIEW



L.S. VIEW

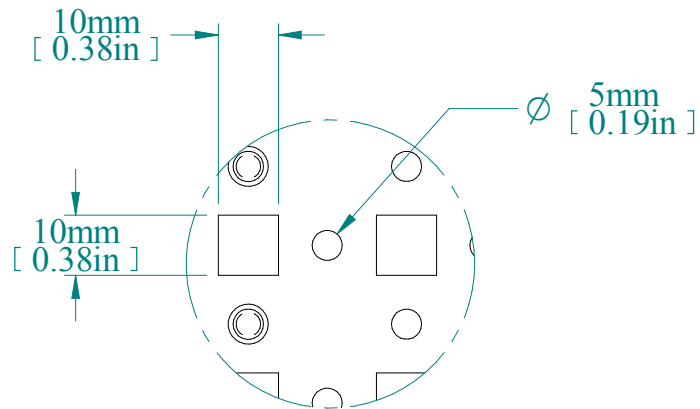

DETAIL A

PART NUMBERS	
HGD35	14 GA STEEL GALVANIZED

NOTES
Grid Straps feature pattern of alternating square holes (for cage nut) and round holes (for M5 or #12 screw ) at standard 25 mm centers See Hammond Website for Additional Accessories.

Data subject to change without notice. Isometric drawing not to scale.

**HAMMOND  
MANUFACTURING™**  
www.hammondmfg.com  
PART NO. HGD35