

GU85T08

N-CHANNEL ENHANCEMENT MODE POWER MOSFET

BVDSS	80V
RDS(ON)	13mΩ
ID	75A

Description

The GU85T08 provide the designer with the best combination of fast switching, ruggedized device design, low on-resistance and cost-effectiveness.

The TO-263 package is universally preferred for all commercial-industrial surface mount applications and suited for low voltage applications such as DC/DC converters.

Features

- *Simple Drive Requirement
- *Lower On-resistance
- *Fast Switching

Package Dimensions

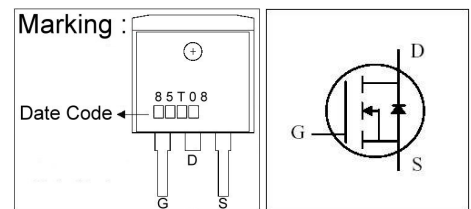
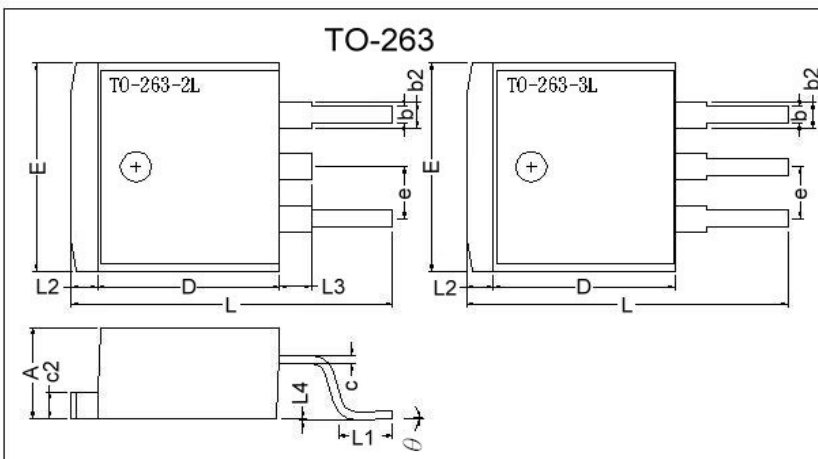

REF.	Millimeter		REF.	Millimeter	
	Min.	Max.		Min.	Max.
A	4.40	4.80	c2	1.25	1.45
b	0.76	1.00	b2	1.17	1.47
L4	0.00	0.30	D	8.6	9.0
c	0.36	0.5	e	2.54 REF.	
L3	1.50 REF.		L	14.6	15.8
L1	2.29	2.79	θ	0°	8°
E	9.80	10.4	L2	1.27 REF.	

Absolute Maximum Ratings

Parameter	Symbol	Ratings	Unit
Drain-Source Voltage	V_{DS}	80	V
Gate-Source Voltage	V_{GS}	± 20	V
Continuous Drain Current, $V_{GS}@10V$	$I_D @T_C=25^\circ C$	75	A
Continuous Drain Current, $V_{GS}@10V$	$I_D @T_C=100^\circ C$	48	A
Pulsed Drain Current ¹	I_{DM}	260	A
Total Power Dissipation	$P_D @T_C=25^\circ C$	138	W
Linear Derating Factor		1.11	W/°C
Single Pulse Avalanche Energy ³	E_{AS}	450	mJ
Avalanche Current	I_{AR}	30	A
Operating Junction and Storage Temperature Range	T_j, T_{stg}	-55 ~ +150	°C

Thermal Data

Parameter	Symbol	Value	Unit
Thermal Resistance Junction-case Max.	R_{thj-c}	0.9	°C/W
Thermal Resistance Junction-ambient Max.	R_{thj-a}	62	°C/W

Electrical Characteristics(T_j = 25°C Unless otherwise specified)

Parameter	Symbol	Min.	Typ.	Max.	Unit	Test Conditions
Drain-Source Breakdown Voltage	BV_{DSS}	80	-	-	V	$V_{GS}=0, I_D=1mA$
Breakdown Voltage Temperature Coefficient	$\Delta BV_{DSS} / \Delta T_j$	-	0.09	-	V/°C	Reference to 25°C, $I_D=1mA$
Gate Threshold Voltage	$V_{GS(th)}$	1.0	-	3.0	V	$V_{DS}=V_{GS}, I_D=250\mu A$
Forward Transconductance	g_{fs}	-	70	-	S	$V_{DS}=10V, I_D=45A$
Gate-Source Leakage Current	I_{GSS}	-	-	±100	nA	$V_{GS}= \pm 20V$
Drain-Source Leakage Current(T _j =25°C)	I_{DSS}	-	-	10	uA	$V_{DS}=80V, V_{GS}=0$
Drain-Source Leakage Current(T _j =150°C)		-	-	100	uA	$V_{DS}=64V, V_{GS}=0$
Static Drain-Source On-Resistance ²	$R_{DS(ON)}$	-	-	13	mΩ	$V_{GS}=10V, I_D=45A$
		-	-	18		$V_{GS}=4.5V, I_D=25A$
Total Gate Charge ²	Q_g	-	63	100	nC	$I_D=45A$ $V_{DS}=64V$ $V_{GS}=4.5V$
Gate-Source Charge	Q_{gs}	-	23	-		
Gate-Drain ("Miller") Charge	Q_{gd}	-	38	-		
Turn-on Delay Time ²	$T_{d(on)}$	-	30	-	ns	$V_{DS}=40V$ $I_D=45A$ $V_{GS}=10V$ $R_G=10\Omega$ $R_D=0.89\Omega$
Rise Time	T_r	-	100	-		
Turn-off Delay Time	$T_{d(off)}$	-	144	-		
Fall Time	T_f	-	173	-		
Input Capacitance	C_{iss}	-	6300	10080	pF	$V_{GS}=0V$ $V_{DS}=25V$ $f=1.0MHz$
Output Capacitance	C_{oss}	-	670	-		
Reverse Transfer Capacitance	C_{rss}	-	350	-		
Gate Resistance	R_g	-	1.1	1.7	Ω	$f=1.0MHz$

Source-Drain Diode

Parameter	Symbol	Min.	Typ.	Max.	Unit	Test Conditions
Forward On Voltage ²	V_{SD}	-	-	1.3	V	$I_S=45A, V_{GS}=0V$
Reverse Recovery Time ²	T_{rr}	-	47	-	ns	$I_S=20A, V_{GS}=0V$ $di/dt=100A/\mu s$
Reverse Recovery Charge	Q_{rr}	-	86	-	nC	

Notes: 1. Pulse width limited by safe operating area.

2. Pulse width ≤ 300us, duty cycle ≤ 2%.

3. Staring T_j=25°C, V_{DD}=30V, L=1mH, R_G=25Ω, I_{AS}=30A.

Characteristics Curve

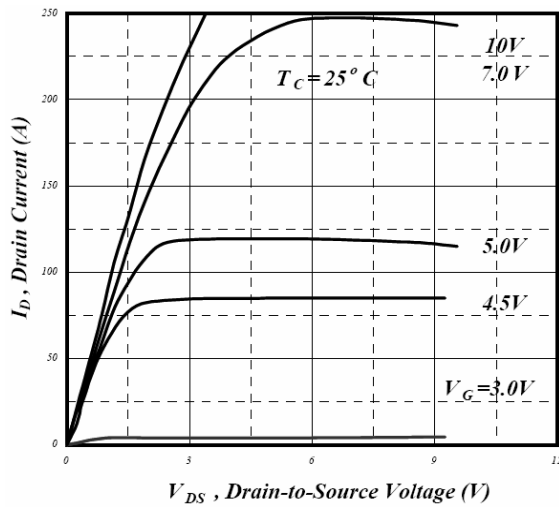

Fig 1. Typical Output Characteristics

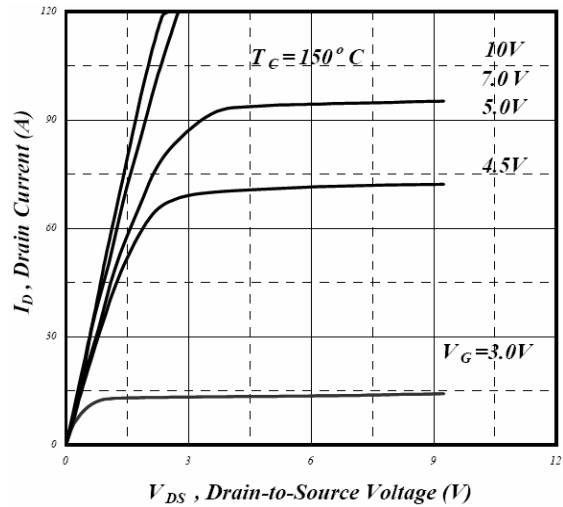

Fig 2. Typical Output Characteristics

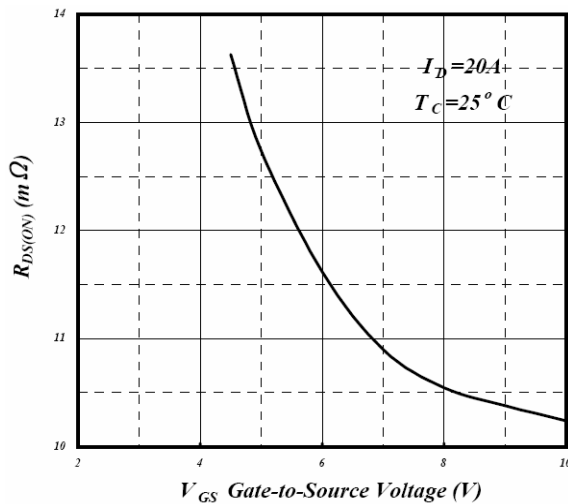

Fig 3. On-Resistance v.s. Gate Voltage

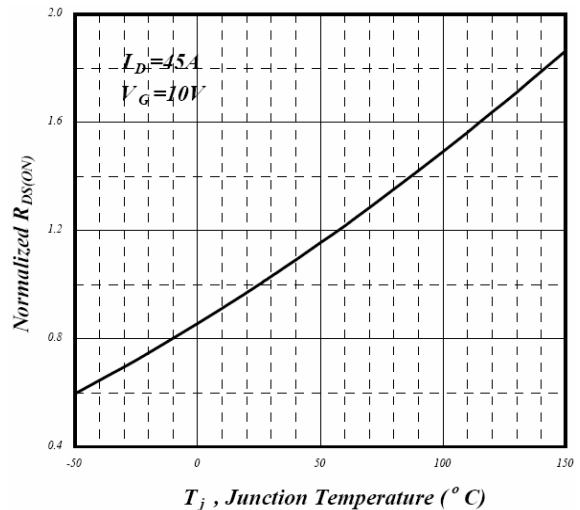

Fig 4. Normalized On-Resistance v.s. Junction Temperature

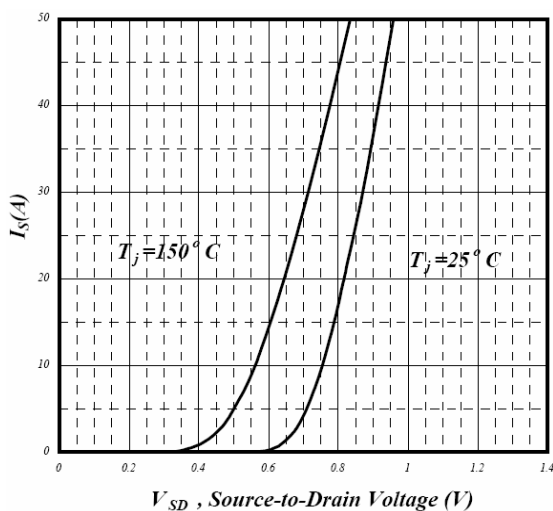

Fig 5. Forward Characteristics of Reverse Diode

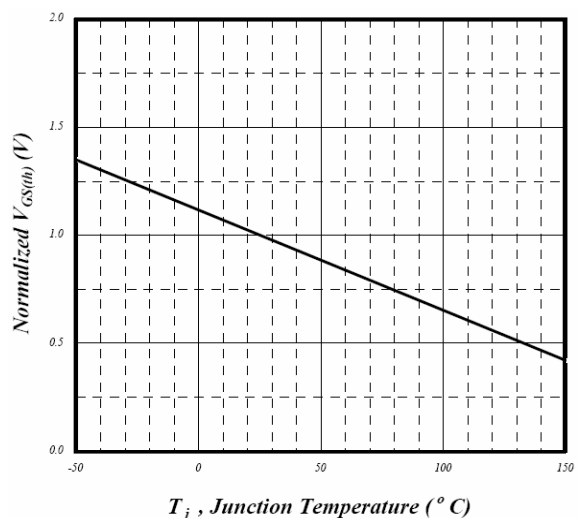

Fig 6. Gate Threshold Voltage v.s. Junction Temperature

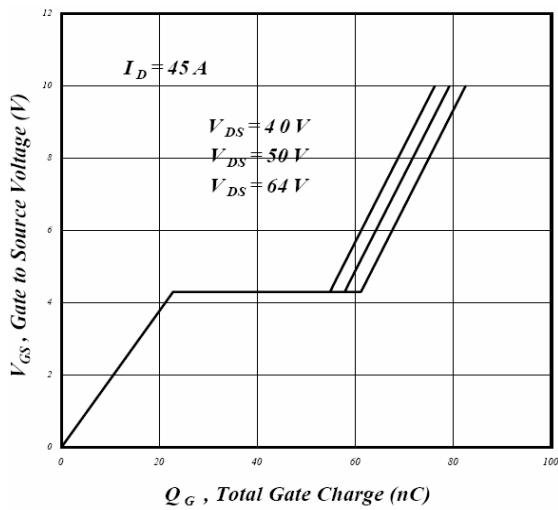

Fig 7. Gate Charge Characteristics

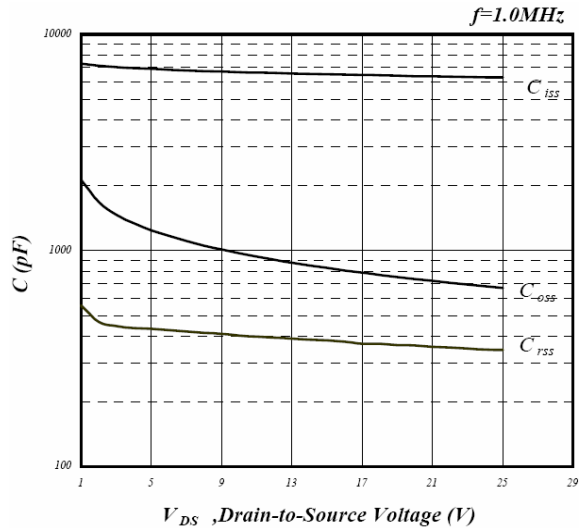

Fig 8. Typical Capacitance Characteristics

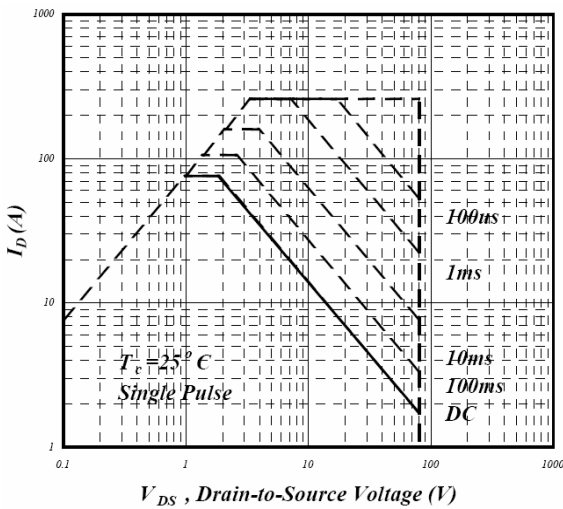

Fig 9. Maximum Safe Operating Area

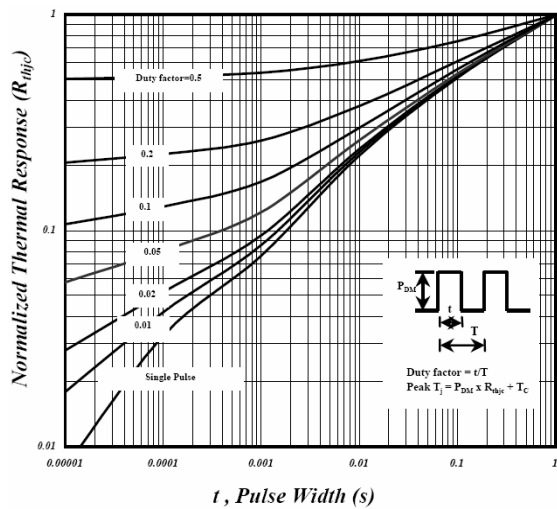

Fig 10. Effective Transient Thermal Impedance

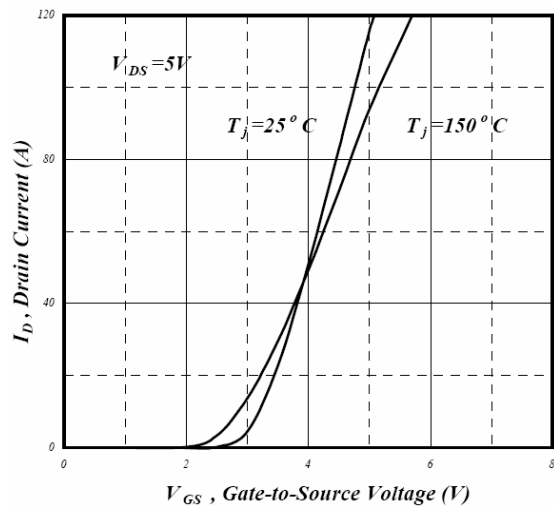

Fig 11. Transfer Characteristics

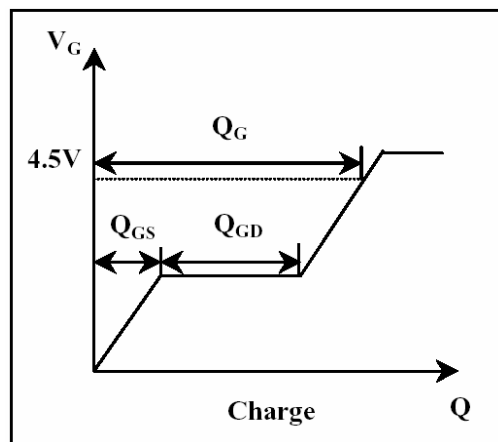

Fig 12. Gate Charge Waveform

Important Notice:
 All rights are reserved. Reproduction in whole or in part is prohibited without the prior written approval of GTM.
 • GTM reserves the right to make changes to its products without notice.
 • GTM semiconductor products are not warranted to be suitable for use in life-support Applications, or systems.
 • GTM assumes no liability for any consequence of customer product design, infringement of patents, or application assistance.
Head Office And Factory:
 • **Taiwan:** No. 17-1 Tatung Rd. Fu Kou Hsin-Chu Industrial Park, Hsin-Chu, Taiwan, R. O. C.
 TEL : 886-3-597-7061 FAX : 886-3-597-9220, 597-0785
 • **China:** (201203) No.255, Jang-Jiang Tsai-Lueng RD. , Pu-Dung-Hsin District, Shang-Hai City, China
 TEL : 86-21-5895-7671 ~ 4 FAX : 86-21-38950165