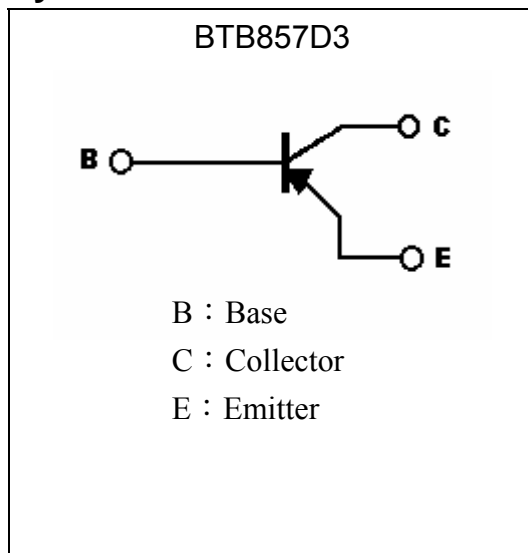
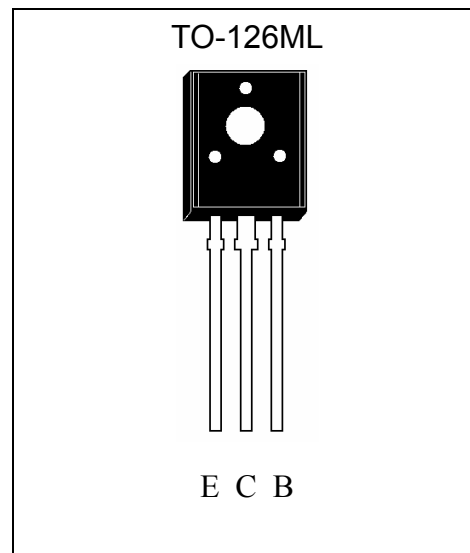

Low Vcesat PNP Epitaxial Planar Transistor

BTB857D3

Features

- Low $V_{CE(sat)}$, $V_{CE(sat)} = -0.3V$ (typical), at $I_C / I_B = -2A / -0.2A$
- Excellent DC current gain characteristics
- Wide SOA
- Complementary to BTC5103D3
- RoHS compliant package

Symbol

Outline

Absolute Maximum Ratings ($T_a = 25^\circ C$)

Parameter	Symbol	Limits	Unit
Collector-Base Voltage	V_{CBO}	-100	V
Collector-Emitter Voltage	V_{CEO}	-100	V
Emitter-Base Voltage	V_{EBO}	-5	V
Collector Current	$I_C(DC)$	-3	A
	$I_C(Pulse)$	-4.5 *1	
Power Dissipation	$P_d(T_A = 25^\circ C)$	1.5	W
	$P_d(T_C = 25^\circ C)$	10	
Junction Temperature	T_j	150	$^\circ C$
Storage Temperature	T_{stg}	-55~+150	$^\circ C$

 Note : *1. Single Pulse $P_w = 10ms$

**Characteristics (Ta=25°C)**

Symbol	Min.	Typ.	Max.	Unit	Test Conditions
BV _{CBO}	-100	-	-	V	I _C =-50μA, I _E =0
BV _{CEO}	-100	-	-	V	I _C =-10mA, I _B =0
BV _{EBO}	-5	-	-	V	I _E =-50μA, I _C =0
I _{CBO}	-	-	-1	μA	V _{CB} =-100V, I _E =0
I _{CEO}	-	-	-10	μA	V _{CE} =-80V, I _B =0
I _{EBO}	-	-	-1	μA	V _{EB} =-5V, I _C =0
*V _{CE(sat)}	-	-0.3	-0.6	V	I _C =-2A, I _B =-200mA
*V _{BE(sat)}	-	-	-1.2	V	I _C =-2A, I _B =-200mA
*h _{FE 1}	180	-	390	-	V _{CE} =-3V, I _C =-500mA
*h _{FE 2}	100	-	-	-	V _{CE} =-2V, I _C =-1A
f _T	-	15	-	MHz	V _{CE} =-5V, I _C =-500mA, f=100MHz

*Pulse Test : Pulse Width ≤380μs, Duty Cycle≤2%

Ordering Information

Device	Package	Shipping	Marking
BTB857D3	TO-126ML (RoHS compliant)	200 pcs / bag, 15 bags/box, 10 boxes/carton	B857

Characteristic Curves

Current Gain vs Collector Current

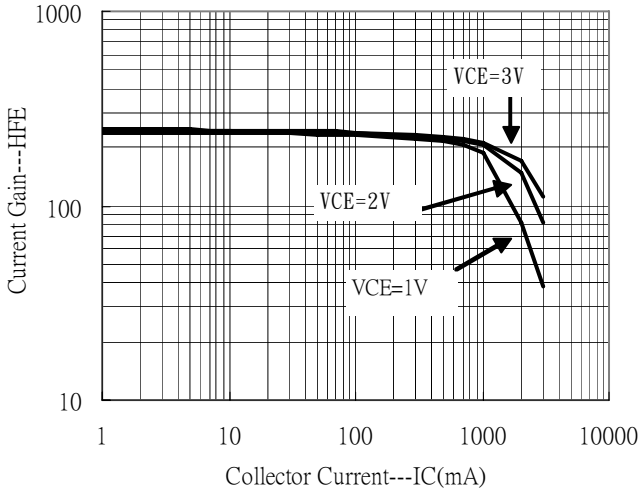

Saturation Voltage vs Collector Current

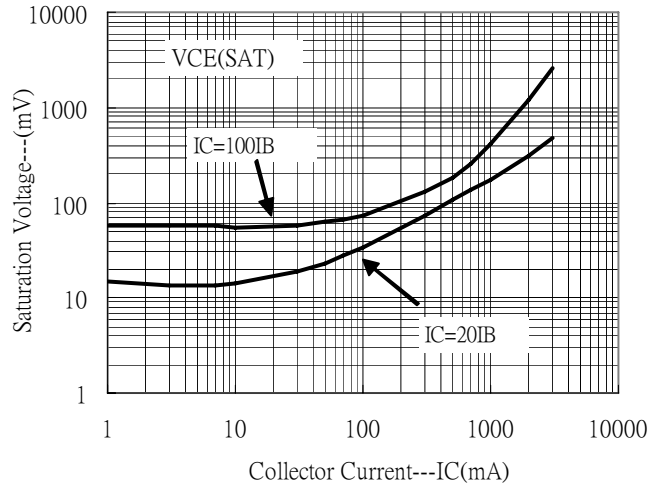

Saturation Voltage vs Collector Current

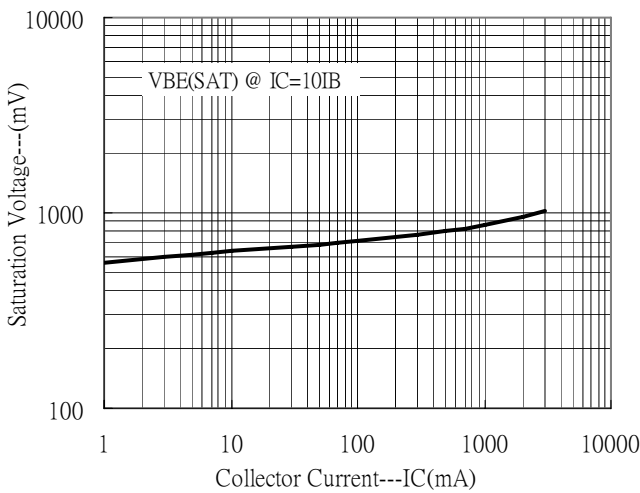

On Voltage vs Collector Current

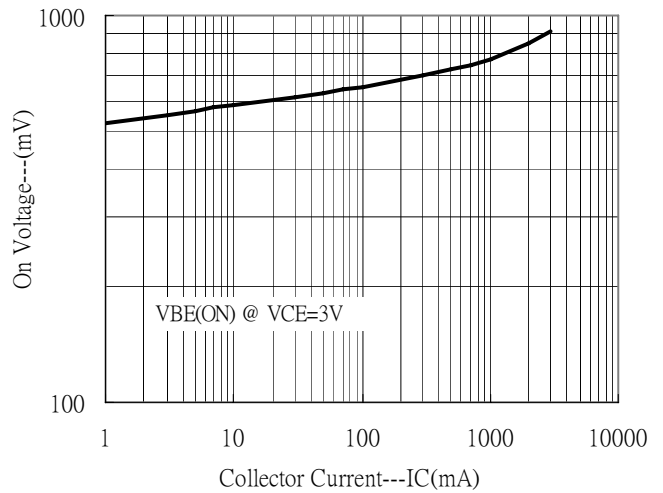

Capacitance vs Reverse-biased Voltage

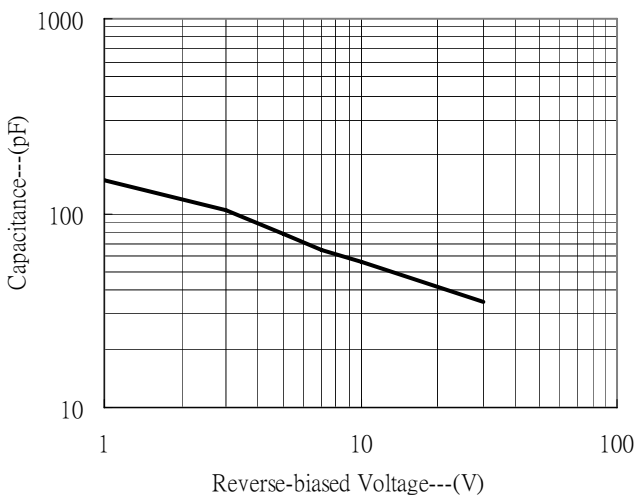

Power Derating Curve

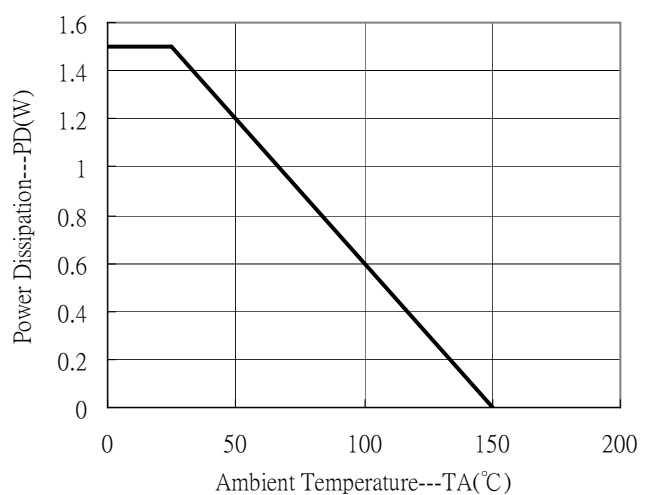



Characteristic Curves(Cont.)

Power Derating Curve

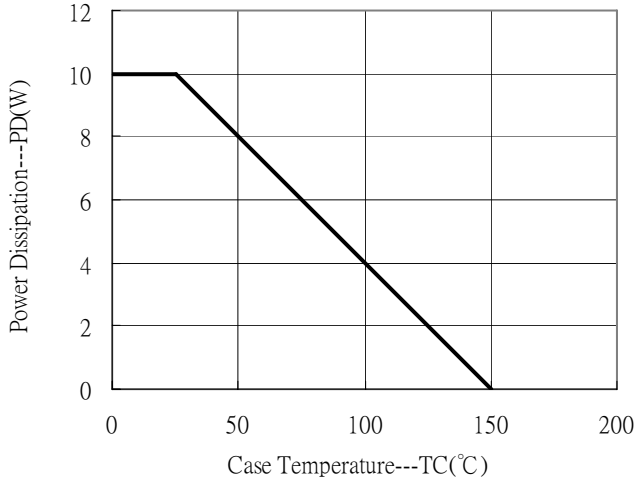

Recommended wave soldering condition

Product	Peak Temperature	Soldering Time
Pb-free devices	260 +0/-5 °C	5 +1/-1 seconds

Recommended temperature profile for IR reflow

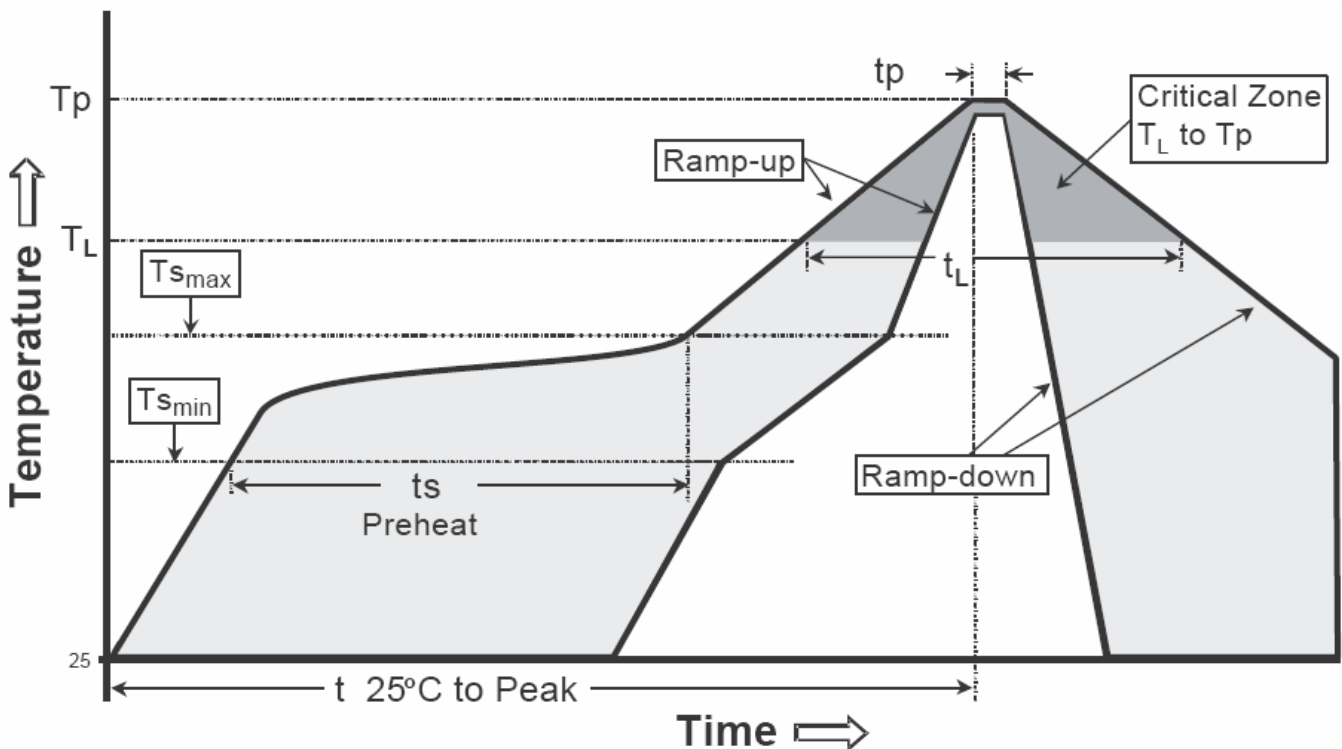

Profile feature	Sn-Pb eutectic Assembly	Pb-free Assembly
Average ramp-up rate (T _{smax} to T _p)	3°C/second max.	3°C/second max.
Preheat		
-Temperature Min(T _{s min})	100°C	150°C
-Temperature Max(T _{s max})	150°C	200°C
-Time(t _{s min} to t _{s max})	60-120 seconds	60-180 seconds
Time maintained above:		
-Temperature (T _L)	183°C	217°C
- Time (t _L)	60-150 seconds	60-150 seconds
Peak Temperature(T _P)	240 +0/-5 °C	260 +0/-5 °C
Time within 5°C of actual peak temperature(tp)	10-30 seconds	20-40 seconds
Ramp down rate	6°C/second max.	6°C/second max.
Time 25 °C to peak temperature	6 minutes max.	8 minutes max.

Note : All temperatures refer to topside of the package, measured on the package body surface.

TO-126ML Dimension

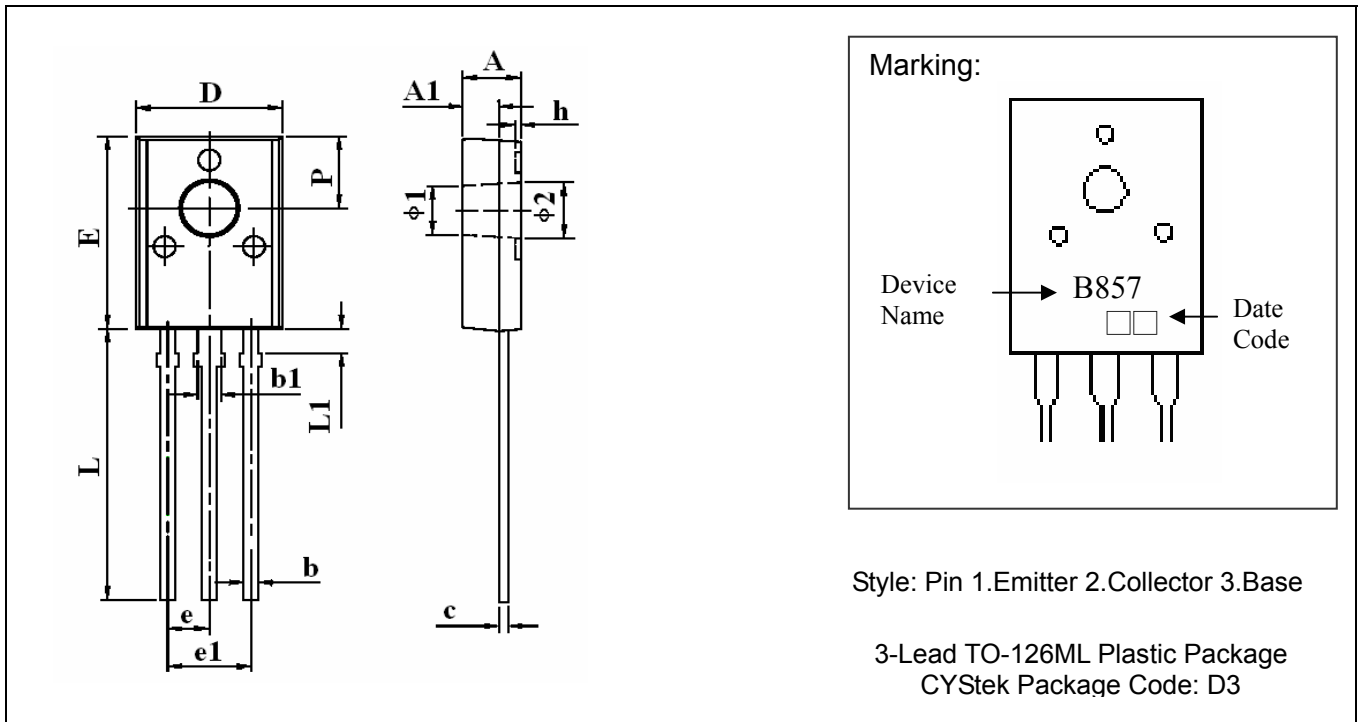

*: Typical

DIM	Inches		Millimeters		DIM	Inches		Millimeters	
	Min.	Max.	Min.	Max.		Min.	Max.	Min.	Max.
A	0.118	0.134	3.000	3.400	e	*0.090		*2.28	
A1	0.071	0.087	1.800	2.200	e1	0.176	0.183	4.460	4.660
b	0.026	0.034	0.660	0.860	L	0.594	0.610	15.100	15.500
b1	0.046	0.054	1.170	1.370	L1	0.051	0.059	1.300	1.500
c	0.018	0.024	0.450	0.600	P	0.159	0.167	4.040	4.240
D	0.307	0.323	7.800	8.200	Φ ₁	0.118	0.126	3.000	3.200
E	0.425	0.441	10.800	11.200	Φ ₂	0.122	0.130	3.100	3.300

Notes: 1. Controlling dimension: millimeters.
 2. Maximum lead thickness includes lead finish thickness, and minimum lead thickness is the minimum thickness of base material.
 3. If there is any question with packing specification or packing method, please contact your local CYStek sales office.

Material:

- Lead: KFC ; pure tin plated
- Mold Compound: Epoxy resin family, flammability solid burning class: UL94V-0

Important Notice:

- All rights are reserved. Reproduction in whole or in part is prohibited without the prior written approval of CYStek.
- CYStek reserves the right to make changes to its products without notice.
- CYStek **semiconductor products are not warranted to be suitable for use in Life-Support Applications, or systems.**
- CYStek assumes no liability for any consequence of customer product design, infringement of patents, or application assistance.