



SPN1306

N-Channel Enhancement Mode MOSFET

DESCRIPTION

The SPN1306 is the N-Channel enhancement mode power field effect transistors are produced using high cell density , DMOS trench technology. This high density process is especially tailored to minimize on-state resistance and provide superior switching performance. These devices are particularly suited for low voltage applications such as notebook computer power management and other battery powered circuits where high-side switching , low in-line power loss, and resistance to transients are needed.

FEATURES

- ◆ N-Channel
30V/0.95A, $R_{DS(ON)}=550m\Omega@V_{GS}=4.5V$
30V/0.75A, $R_{DS(ON)}=650m\Omega@V_{GS}=2.5V$
30V/0.65A, $R_{DS(ON)}=850m\Omega@V_{GS}=1.8V$
- ◆ Super high density cell design for extremely low $R_{DS(ON)}$
- ◆ Exceptional on-resistance and maximum DC current capability
- ◆ SOT-323 package design

APPLICATIONS

- Power Management in Note book
- Portable Equipment
- Battery Powered System
- DC/DC Converter
- Load Switch
- DSC
- LCD Display inverter

PIN CONFIGURATION(SOT-323)

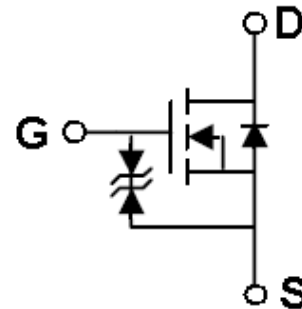
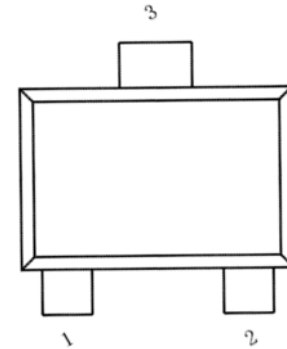

PART MARKING

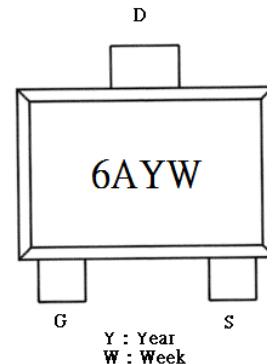



SPN1306

N-Channel Enhancement Mode MOSFET

PIN DESCRIPTION

Pin	Symbol	Description
1	G	Gate
2	S	Source
3	D	Drain

ORDERING INFORMATION

Part Number	Package	Part Marking
SPN1306S32RGB	SOT-323	6A

※ SPN1306S32RGB : Tape Reel ; Pb – Free ; Halogen – Free

ABSOLUTE MAXIMUM RATINGS

($T_A=25^{\circ}\text{C}$ Unless otherwise noted)

Parameter	Symbol	Typical	Unit
Drain-Source Voltage	V_{DSS}	30	V
Gate –Source Voltage	V_{GSS}	± 12	V
Continuous Drain Current($T_J=150^{\circ}\text{C}$)	I_D	0.65	A
	$T_A=25^{\circ}\text{C}$		
Pulsed Drain Current	I_{DM}	0.45	A
Continuous Source Current(Diode Conduction)	I_S	0.3	A
Power Dissipation	P_D	0.15	W
	$T_A=25^{\circ}\text{C}$		
Operating Junction Temperature	T_J	-55/150	$^{\circ}\text{C}$
Storage Temperature Range	T_{STG}	-55/150	$^{\circ}\text{C}$



SPN1306

N-Channel Enhancement Mode MOSFET

ELECTRICAL CHARACTERISTICS

(TA=25°C Unless otherwise noted)

Parameter	Symbol	Conditions	Min.	Typ	Max.	Unit
Static						
Drain-Source Breakdown Voltage	$V_{(BR)DSS}$	$V_{GS}=0V, I_D=250\mu A$	30			V
Gate Threshold Voltage	$V_{GS(th)}$	$V_{DS}=V_{GS}, I_D=250\mu A$	0.35		1.0	
Gate Leakage Current	I_{GSS}	$V_{DS}=0V, V_{GS}=\pm 12V$			30	μA
Zero Gate Voltage Drain Current	I_{DSS}	$V_{DS}=24V, V_{GS}=0V$			1	μA
		$V_{DS}=24V, V_{GS}=0V$ $T_J=55^\circ C$			5	
On-State Drain Current	$I_{D(on)}$	$V_{DS} \geq 4.5V, V_{GS}=5V$	0.7			A
Drain-Source On-Resistance	$R_{DS(on)}$	$V_{GS}=4.5V, I_D=0.95A$		0.45	0.55	Ω
		$V_{GS}=2.5V, I_D=0.75A$		0.50	0.65	
		$V_{GS}=1.8V, I_D=0.65A$		0.75	0.85	
Forward Transconductance	g_{fs}	$V_{DS}=10V, I_D=0.4A$		1.0		S
Diode Forward Voltage	V_{SD}	$I_S=0.15A, V_{GS}=0V$		0.8	1.2	V
Dynamic						
Total Gate Charge	Q_g	$V_{DS}=10V, V_{GS}=4.5V,$ $I_D=0.6A$		1.2	1.5	nC
Gate-Source Charge	Q_{gs}			0.2		
Gate-Drain Charge	Q_{gd}			0.3		
Turn-On Time	$t_{d(on)}$	$V_{DD}=10V, R_L=10\Omega,$ $I_D=0.5A$ $V_{GEN}=4.5V, R_G=6\Omega$		5	10	ns
	t_r			8	15	
Turn-Off Time	$t_{d(off)}$			10	18	
	t_f			1.2	2.8	



SPN1306

N-Channel Enhancement Mode MOSFET

TYPICAL CHARACTERISTICS

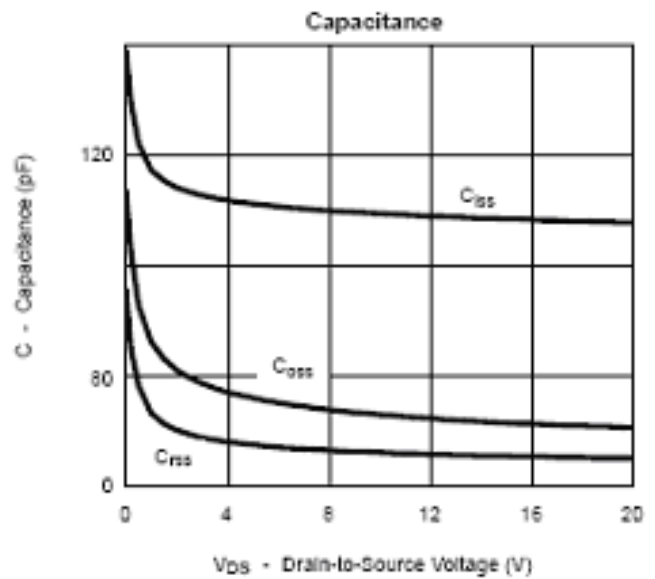
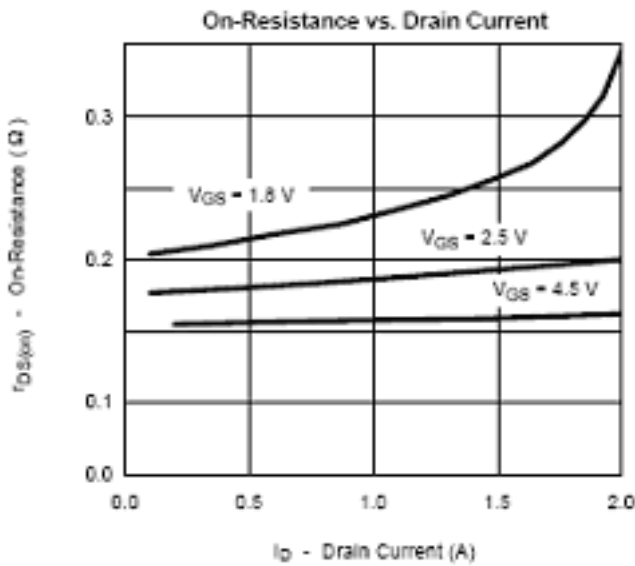
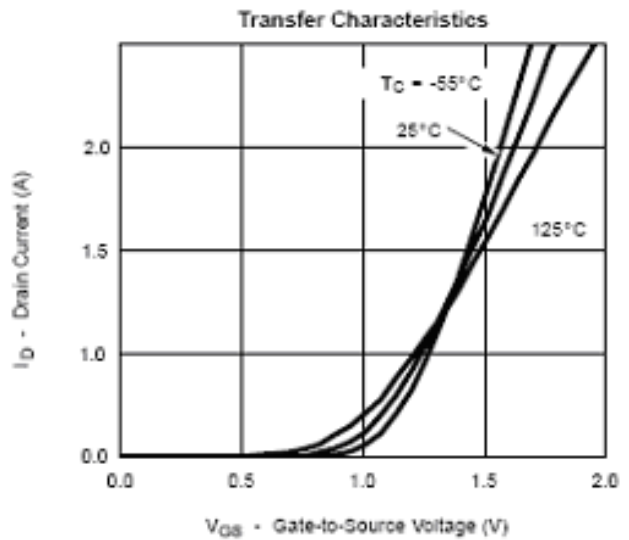
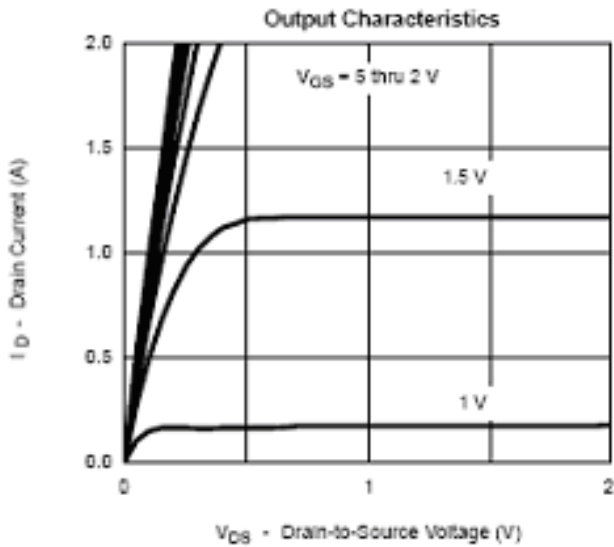



SPN1306

N-Channel Enhancement Mode MOSFET

TYPICAL CHARACTERISTICS

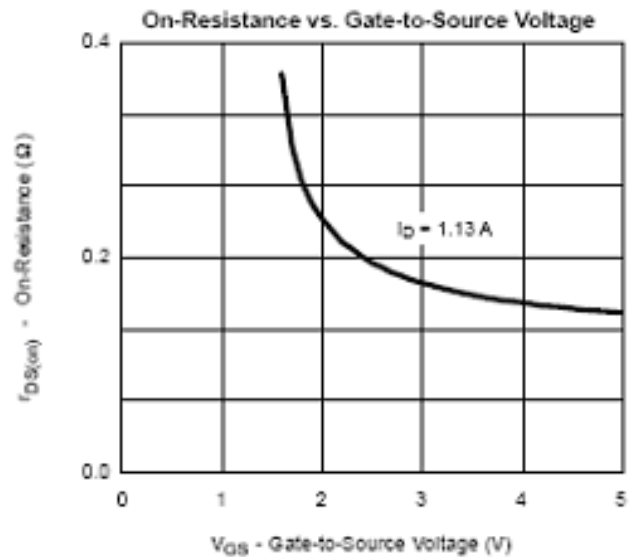
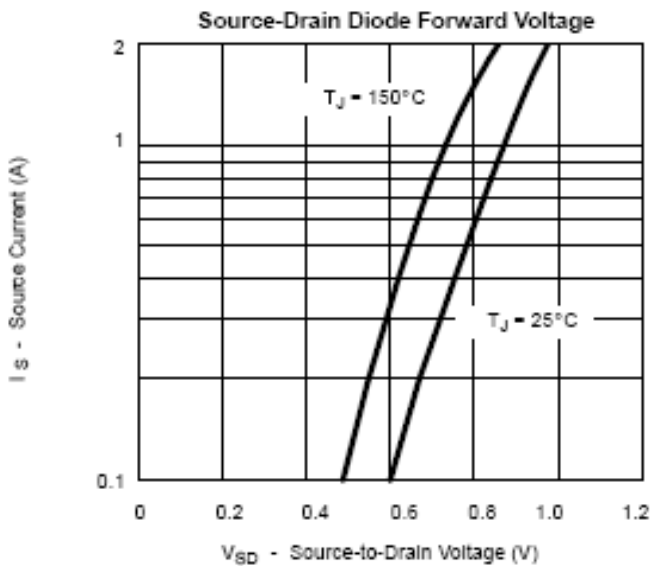
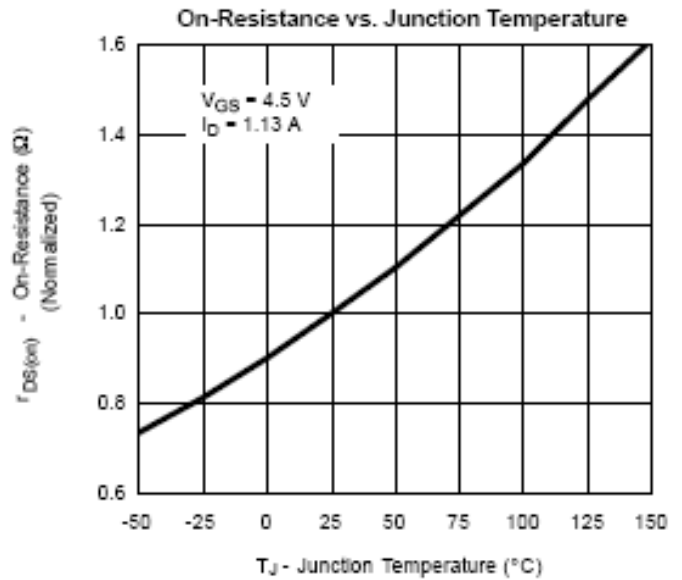
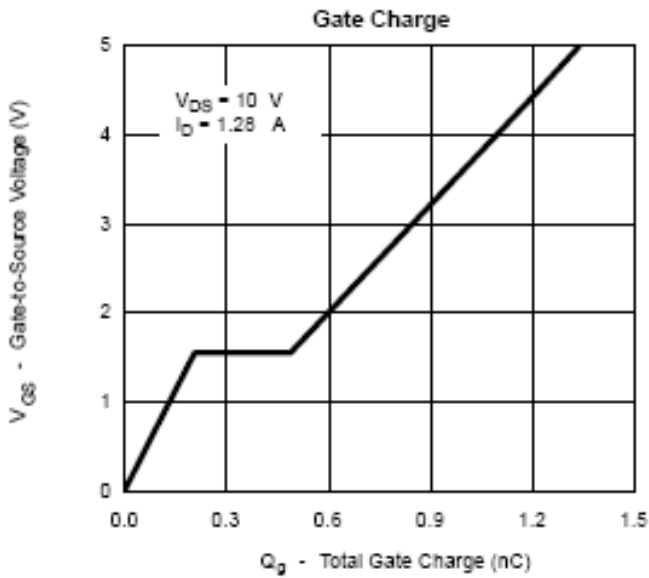



SPN1306

N-Channel Enhancement Mode MOSFET

TYPICAL CHARACTERISTICS

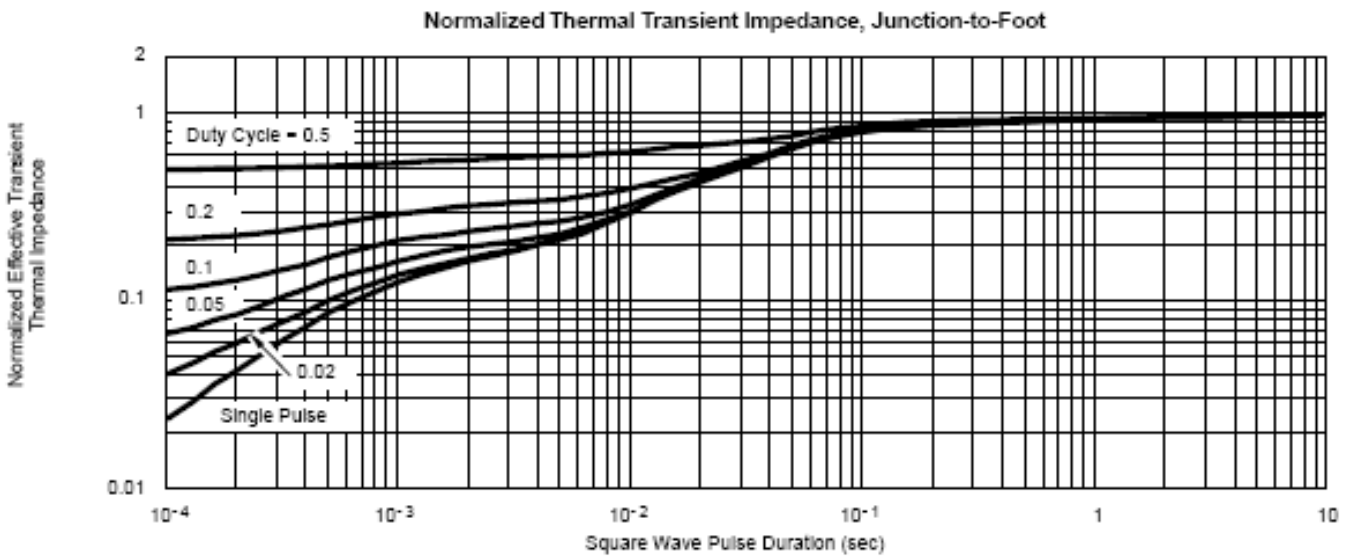
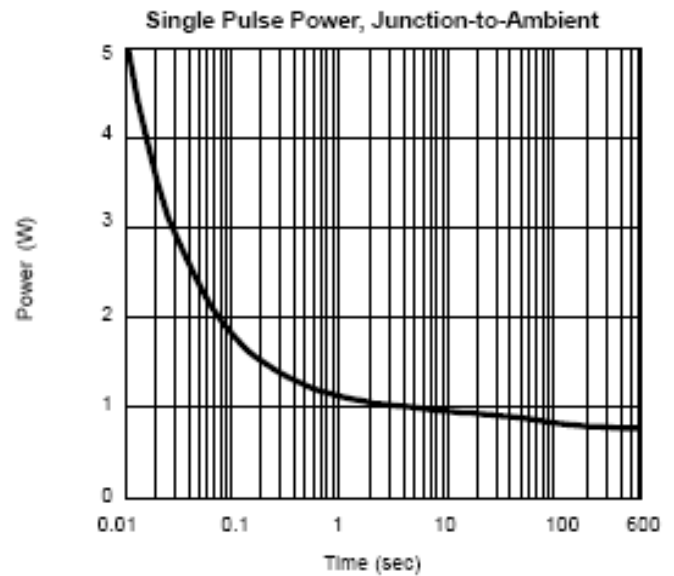
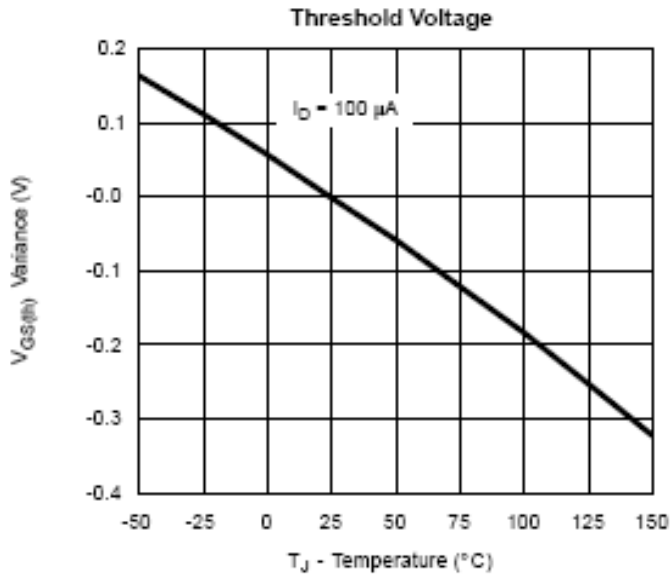



SPN1306

N-Channel Enhancement Mode MOSFET

SOT-323 PACKAGE OUTLINE

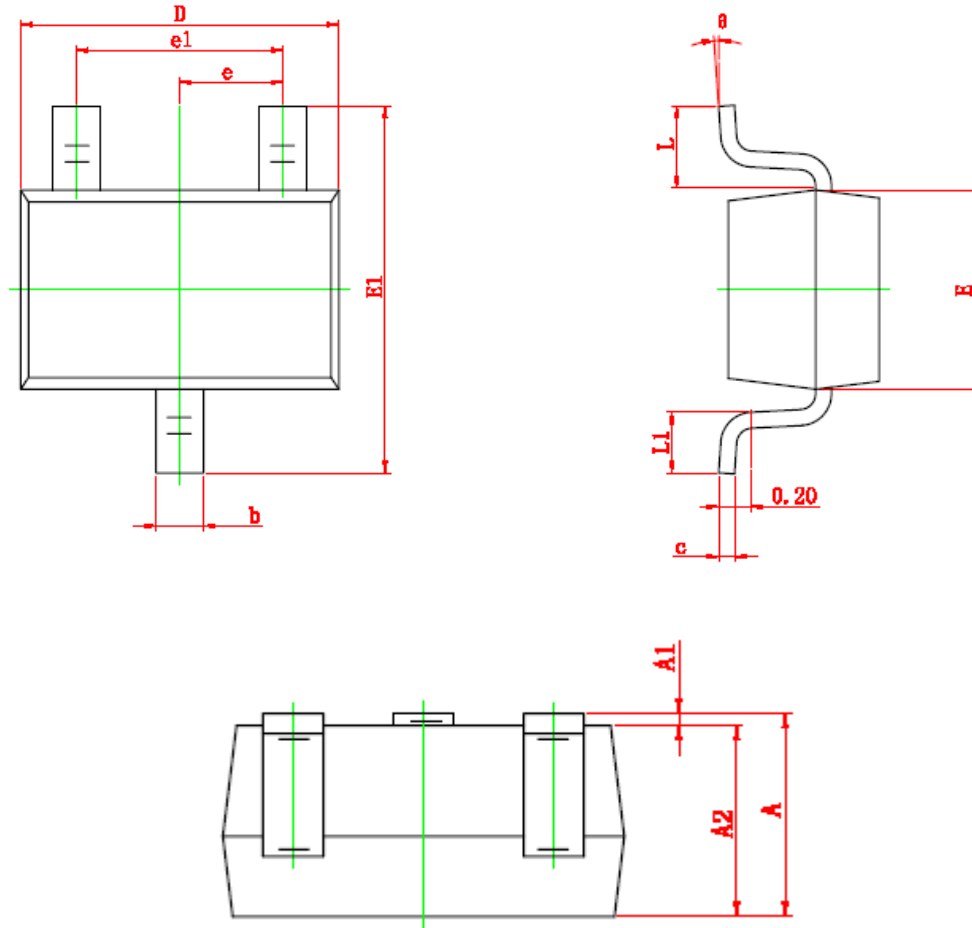

Symbol	Dimensions In Millimeters		Dimensions In Inches	
	Min	Max	Min	Max
A	0.900	1.100	0.035	0.043
A1	0.000	0.100	0.000	0.004
A2	0.900	1.000	0.035	0.039
b	0.200	0.400	0.008	0.016
c	0.080	0.150	0.003	0.006
D	2.000	2.200	0.079	0.087
E	1.150	1.350	0.045	0.053
E1	2.150	2.450	0.085	0.096
e	0.650 TYP		0.026 TYP	
e1	1.200	1.400	0.047	0.055
L	0.525 REF		0.021 REF	
L1	0.260	0.460	0.010	0.018
θ	0°	8°	0°	8°



SPN1306

N-Channel Enhancement Mode MOSFET

Information provided is alleged to be exact and consistent. SYNC Power Corporation presumes no responsibility for the penalties of use of such information or for any violation of patents or other rights of third parties which may result from its use. No license is granted by allegation or otherwise under any patent or patent rights of SYNC Power Corporation. Conditions mentioned in this publication are subject to change without notice. This publication surpasses and replaces all information previously supplied. SYNC Power Corporation products are not authorized for use as critical components in life support devices or systems without express written approval of SYNC Power Corporation.

©The SYNC Power logo is a registered trademark of SYNC Power Corporation

©2004 SYNC Power Corporation – Printed in Taiwan – All Rights Reserved

SYNC Power Corporation

7F-2, No.3-1, Park Street

NanKang District (NKSP), Taipei, Taiwan 115

Phone: 886-2-2655-8178

Fax: 886-2-2655-8468

©<http://www.syncpower.com>
