

Three-Phase Bridge + Thyristor, 200A

MTPT20008 Thru MTPT20016

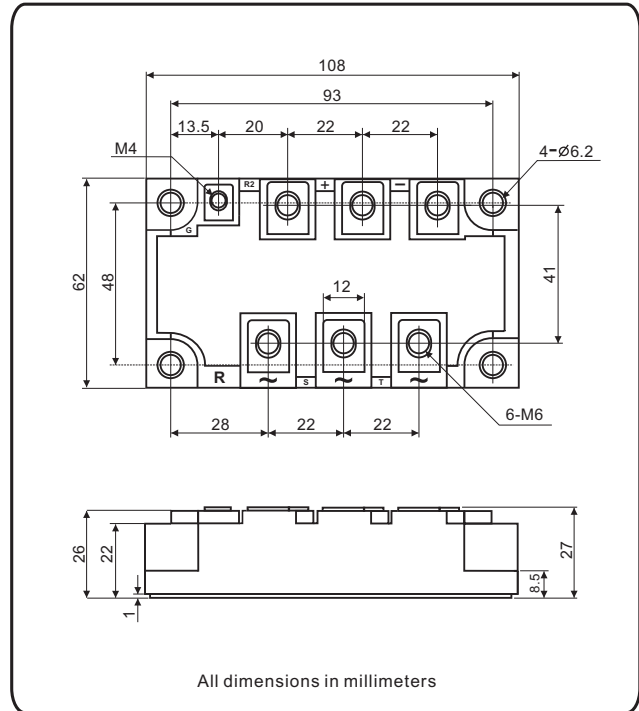
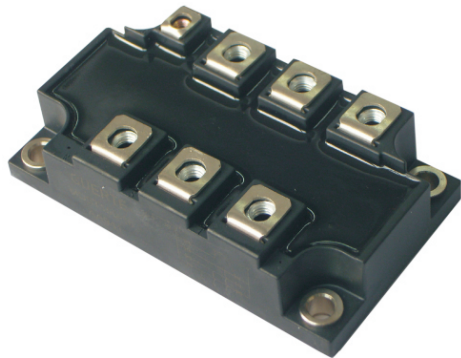

FEATURES

- UL recognition file number E320098
- Three-phase bridge and a thyristor
- High surge current capability
- Low thermal resistance
- Compliant to RoHS
- Isolation voltage up to 2500V

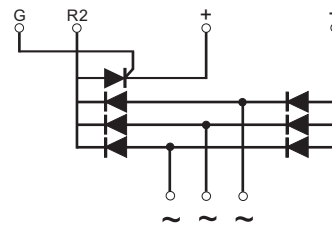

Applications

- Inverter for AC or DC motor control
- Current stabilized power supply
- Switching power supply

ADVANTAGE

- International standard package
Epoxy meets UL 94 V-O flammability rating
- Small volume, light weight
- Small thermal resistance
- Weight: 470g (16.6 ozs)

PRIMARY CHARACTERISTICS	
$I_{F(AV)}$	200A
V_{RRM}	800V to 1600V
I_{FSM}	1900A
I_R	20 μ A
V_{FM}/V_{TM}	1.3V
$T_J \text{ max.}$	150°C

© Maximum Ratings for Diodes

MAJOR RATINGS AND CHARACTERISTICS ($T_A = 25^\circ\text{C}$ unless otherwise noted)					
PARAMETER	SYMBOL	MTPT200			UNIT
		08	12	16	
Maximum repetitive peak reverse voltage	V_{RRM}/V_{RRM}	800	1200	1600	V
Peak reverse non-repetitive voltage	V_{RSM}	900	1300	1700	V
Output DC current three-phase full wave, $T_c = 100^\circ\text{C}$	I_o	200			A
Peak forward surge current single sine-wave superimposed on rated load	I_{FSM}	1900			A
Rating (non-repetitive, for t greater than 1 ms and less than 8.3 ms) for fusing	I^2t	18050			A^2s
Operating junction temperature range	T_J	-40 to 150			$^\circ\text{C}$
Storage temperature range	T_{STG}	-40 to 125			$^\circ\text{C}$

ELECTRICAL CHARACTERISTICS ($T_A = 25^\circ\text{C}$ unless otherwise noted)						
PARAMETER	TEST CONDITIONS	SYMBOL	MTPT200			UNIT
			08	12	16	
Maximum instantaneous forward drop per diode	$I_F = 200\text{A}$	V_F	1.3			V
Maximum reverse DC current at rated DC blocking voltage per diod	$T_A = 25^\circ\text{C}$	I_R	20			μA
	$T_A = 150^\circ\text{C}$		10			mA

© Maximum Ratings fo Thyristor

FORWARD CONDUCTION							
PARAMETER	SYMBOL	TEST CONDITIONS		VALUES	UNITS		
Maximum average on-state current at case temperature	$I_{T(AV)}$	180° conduction, half sine wave ,50Hz		200	A		
				85	$^\circ\text{C}$		
Maximum peak, one-cycle, on-state non-repetitive surge current	I_{TSM}	t = 10 ms	No voltage reappplied	Sine half wave, initial $T_J = T_J$ maximum	1900	A	
		t = 8.3 ms			1995		
Maximum I^2t for fusing	I^2t	t = 10 ms			100% V_{RRM} reappplied	18	kA^2s
		t = 8.3 ms				16.4	
		t = 10 ms	12.6				
		t = 8.3 ms	11.5				
Maximum $I^2\sqrt{t}$ for fusing	$I^2\sqrt{t}$	t = 0.1 ms to 10 ms, no voltage reappplied		180.5	$\text{kA}^2\sqrt{\text{s}}$		
Maximum on-state voltage drop	V_{TM}	$I_{TM} = 200\text{A}$, $T_J = 25^\circ\text{C}$, 180° conduction		1.3	V		
Maximum holding current	I_H	Anode supply = 12 V initial $I_T = 30\text{A}$, $T_J = 25^\circ\text{C}$		200	mA		
Maximum latching current	I_L	Anode supply = 12 V resistive load = 1 Ω Gate pulse: 10 V, 100 μs , $T_J = 25^\circ\text{C}$		400			

SWITCHING					
PARAMETER	SYMBOL	TEST CONDITIONS		VALUES	UNITS
Typical delay time	t_d	$T_J = 25^\circ\text{C}$, gate current = 1A $dI_g/dt = 1\text{A}/\mu\text{s}$ $V_d = 0.67\% V_{DRM}$		1	μs
Typical rise time	t_r			2	
Typical tum-off time	t_q	$I_{TM} = 300\text{A}$; $dI/dt = 15\text{A}/\mu\text{s}$; $T_J = T_J$ maximum, $V_R = 50\text{V}$; $dV/dt = 20\text{V}/\mu\text{s}$; gate 0V ,100 Ω		50 to 150	

BLOCKING					
PARAMETER	SYMBOL	TEST CONDITIONS		VALUES	UNITS
Maximum peak reverse and off-state leakage current	I_{RRM} , I_{DRM}	$T_J = 125\text{ }^\circ\text{C}$		30	mA
RMS isolation Voltage	V_{ISO}	50 Hz, circuit to base, all terminals shorted, $25\text{ }^\circ\text{C}$, 60s		3000	V
Critical rate of rise of off-state voltage	dV/dt	$T_J = T_J$ maximum, exponential to 67 % rated V_{DRM}		500	V/ μ s

TRIGGERING					
PARAMETER	SYMBOL	TEST CONDITIONS		VALUES	UNITS
Maximum peak gate power	P_{GM}	$t_p \leq 5\text{ ms}$, $T_J = T_J$ maximum		15	W
Maximum average gate power	$P_{G(AV)}$	f = 50 Hz, $T_J = T_J$ maximum		5	
Maximum peak gate current	I_{GM}	$t_p \leq 5\text{ ms}$, $T_J = T_J$ maximum		3	A
Maximum peak negative gate voltage	- V_{GT}			10	V
Maximum required DC gate voltage to trigger	V_{GT}	$T_J = 25\text{ }^\circ\text{C}$	Anode supply = 12 V, resistive load; $R_a = 1\ \Omega$	3	mA
Maximum required DC gate current to trigger	I_{GT}			100	
Maximum gate voltage that will not trigger	V_{GD}	$T_J = T_J$ maximum, 67% V_{DRM} applied		0.25	V
Maximum gate current that will not trigger	I_{GD}			10	mA
Maximum rate of rise of turned-on current	dI/dt	$T_J = 25\text{ }^\circ\text{C}$, $I_{GM} = 1.5\text{ A}$, $t_r \leq 0.5\ \mu\text{s}$		200	A/ μ s

THERMAL AND MECHANICAL SPECIFICATIONS					
PARAMETER	SYMBOL	TEST CONDITIONS		VALUES	UNITS
junction operating and storage temperature range	T_J , T_{stg}			- 40 to 125	$^\circ\text{C}$
Maximum thermal resistance, junction to case per junction	R_{thJC}	DC operation		0.14	$^\circ\text{C/W}$
Typical thermal resistance, case to heatsink per module	R_{thCS}	Mounting surface, smooth, flat and greased		0.06	
Mounting torque $\pm 10\%$ to heatsink, M6 to terminal, M6/M4		A mounting compound is recommended and the torque should be rechecked after a period of about 3 hours to allow for the spread of the compound.		5	N.m
				5 / 2	
Approximate weight				470	g
				16.6	oz.

Device code

MTPT	200	16
-------------	------------	-----------

① ② ③

- ① - Module type : "MTPT" for 3Ø Bridge + Thyristor
- ② - $I_{F(AV)}$ rating : "200" for 200 A
- ③ - Voltage code : code x 100 = V_{RRM}

Fig.1 Power dissipation

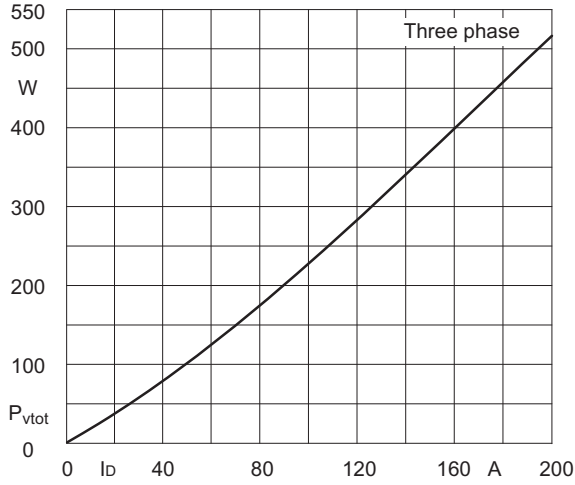

Fig.2 Forward current derating curve

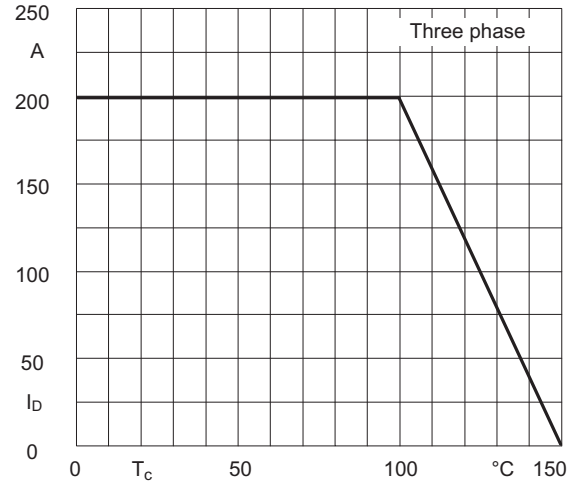

Fig.3 Transient thermal impedance

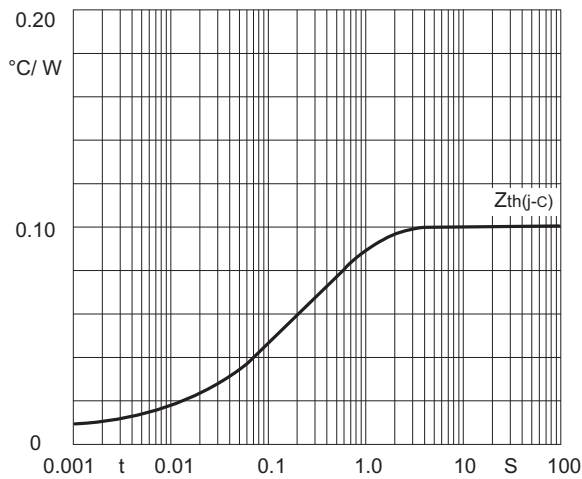

Fig.4 Max non-repetitive forward surge current

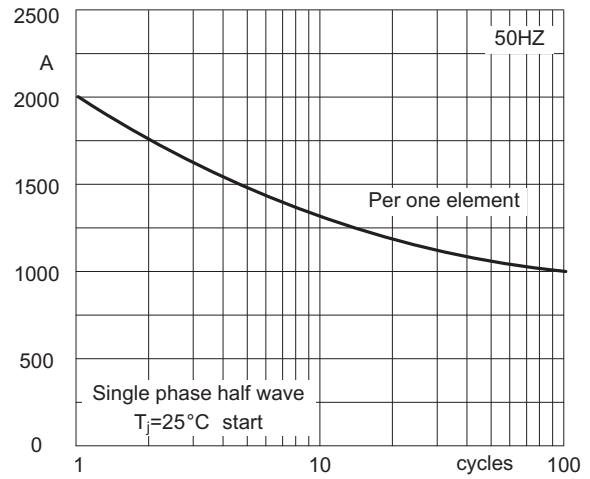

Fig.5 Forward characteristics

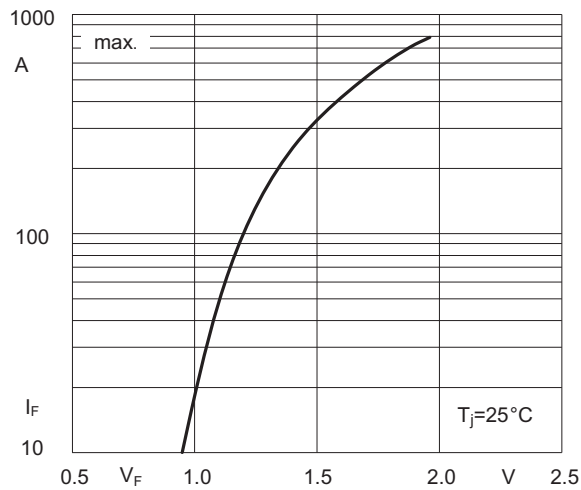

Fig.6 SCR power dissipation

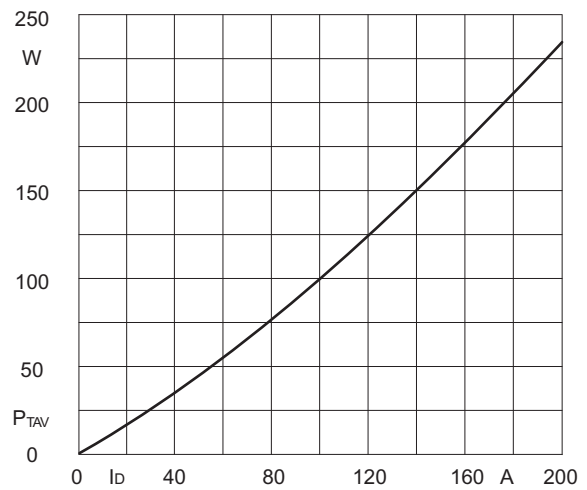

Fig.7 SCR forward current derating curve

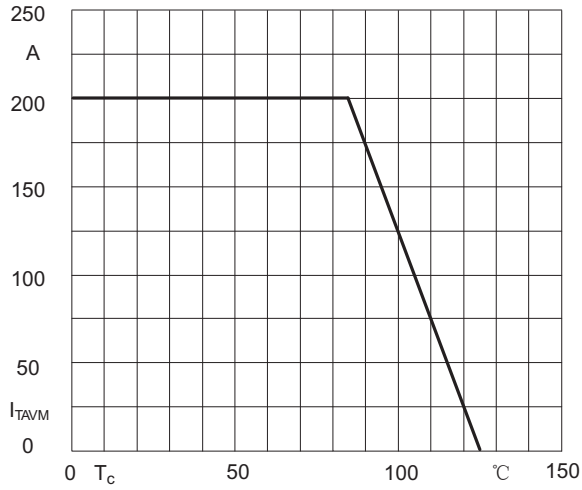

Fig.8 SCR transient thermal impedance

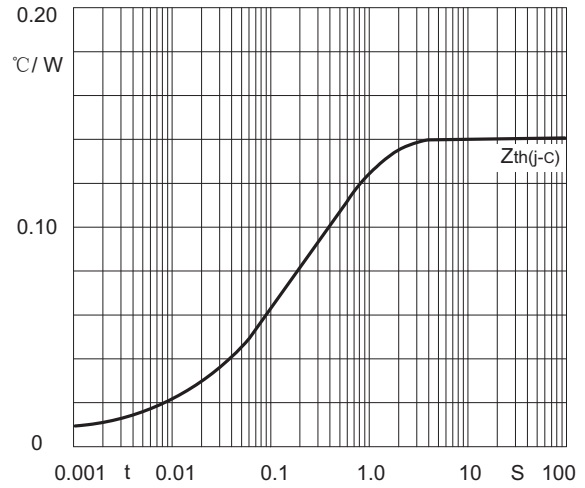

Fig.9 SCR forward characteristics

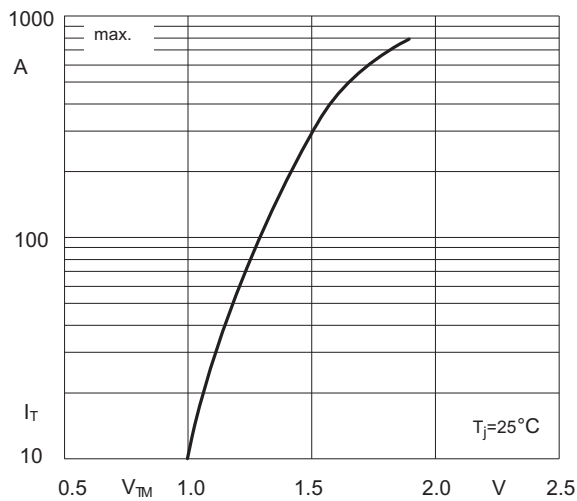

Fig.10 Gate trigger characteristics

