

Features

- Low saturation switching application
- Power amplifier
- High Voltage : $V_{CEO}=80V$ Min.
- Complement to STB1017PI

PIN Connection

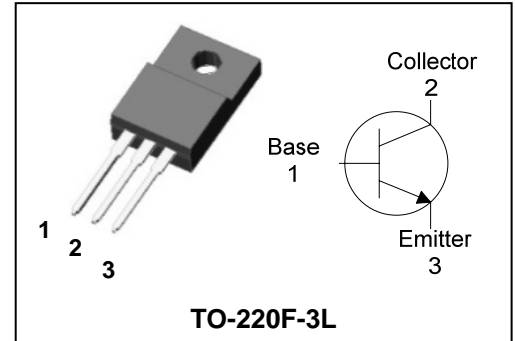

Ordering Information

Type NO.	Marking	Package Code
STD1408PI	STD1408	TO-220F-3L

Marking Diagram

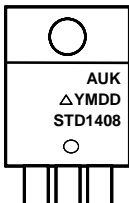
	<p>Column 1 : Manufacturer</p> <p>Column 2 : Production Information - Δ : Factory Management Code - YMDD : Date Code (Year, Month, Date)</p> <p>Column 3 : Device Code</p>
--	--

Absolute maximum ratings

Characteristic	Symbol	Rating	Unit
Collector-Base voltage	V_{CBO}	80	V
Collector-Emitter voltage	V_{CEO}	80	V
Emitter-base voltage	V_{EBO}	5	V
Collector current	I_C	4	A
	I_{CP}^*	8	A(Pulse)
Collector Power dissipation ($T_c=25^\circ C$)	P_C	15	W
Junction temperature	T_j	150	$^\circ C$
Storage temperature	T_{stg}	-55 ~ 150	$^\circ C$

* : Single pulse, $t_p=300 \mu s$

Characteristic		Symbol	Typ.	Max	Unit
Thermal resistance	Junction-case	$R_{th(J-C)}$	-	8.33	$^\circ C/W$
	Junction-ambient	$R_{th(J-a)}$	-	62.5	

Electrical Characteristics

Characteristic	Symbol	Test Condition	Min.	Typ.	Max.	Unit
Collector cut-off current	I_{CBO}	$V_{CB}=80V, I_E=0$	-	-	10	μA
Emitter cut-off current	I_{EBO}	$V_{EB}=5V, I_C=0$	-	-	10	μA
Collector-Emitter breakdown voltage	$V_{(BR)CEO}$	$I_C=50mA, I_B=0$	80	-	-	V
DC current gain	h_{FE}	$V_{CE}=5V, I_C=0.5A$	120	-	240	-
		$V_{CE}=5V, I_C=3A$	40	-	-	-
Collector-Emitter saturation voltage	$V_{CE(sat)}$	$I_C=3A, I_B=0.3A$	-	0.45	1.5	V
Base-Emitter saturation voltage	$V_{BE(on)}$	$V_{CE}=5V, I_B=3A$	-	1.0	1.5	V
Transition frequency	f_T	$V_{CB}=5V, I_C=0.5A$	-	8	-	MHz
Collector output capacitance	C_{ob}	$V_{CB}=10V, I_E=0, f=1MHz$	-	40	-	pF

* hFE rank : 120~240 Only

Electrical Characteristic Curves

Fig. 1 $P_C - T_a$

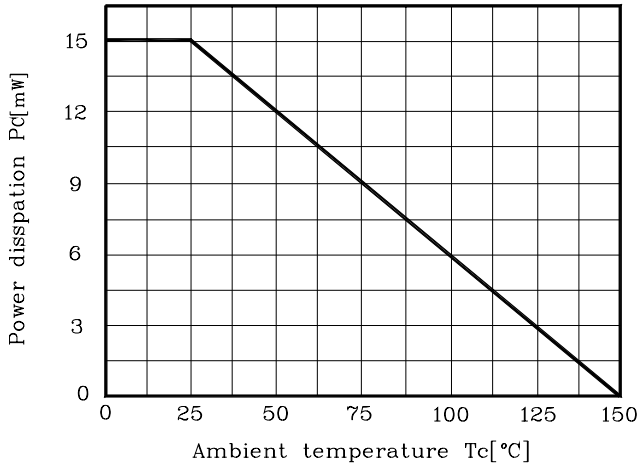

Fig. 2 $I_C - V_{BE}$

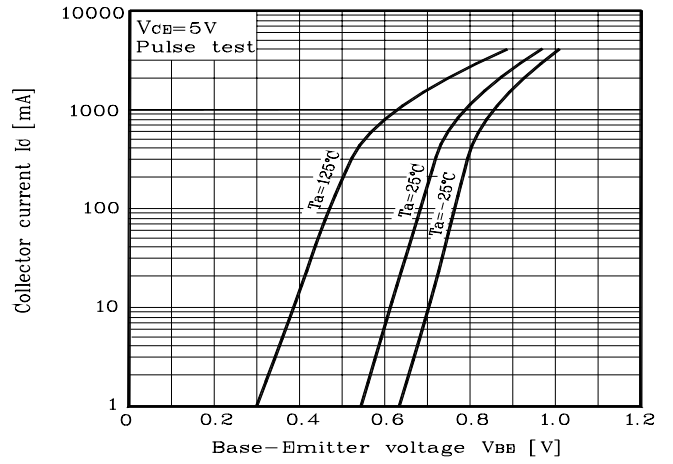

Fig. 3 $I_C - V_{CE}$

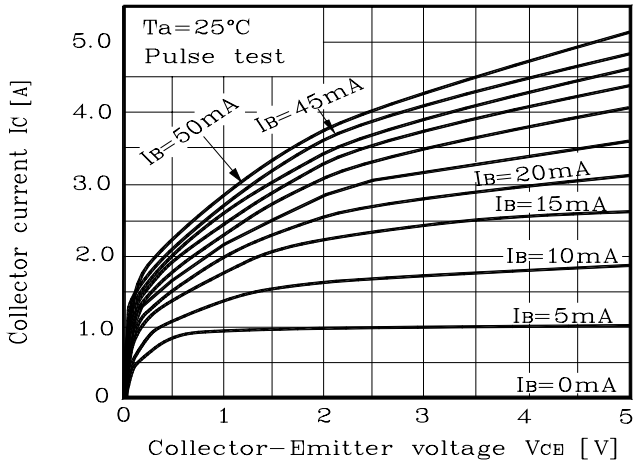

Fig. 4 $h_{FE} - I_C$

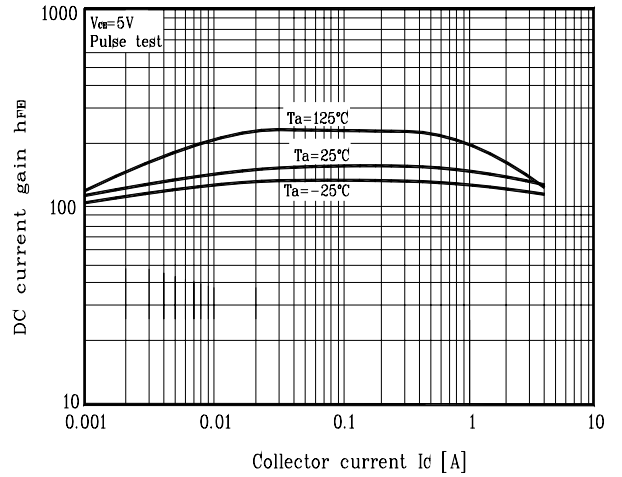

Fig. 5 $V_{CE(sat)} - I_C$

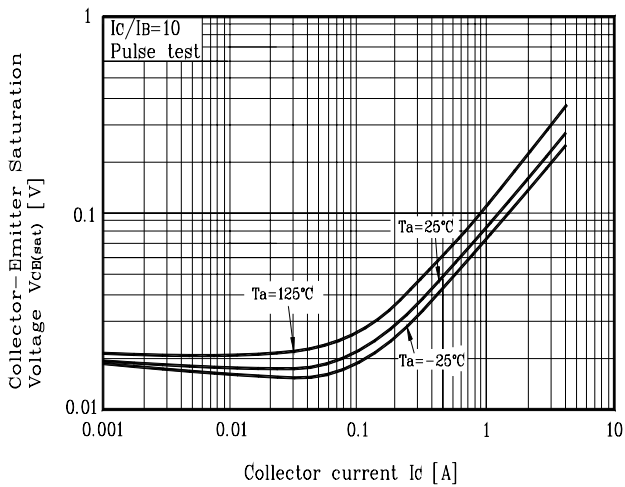
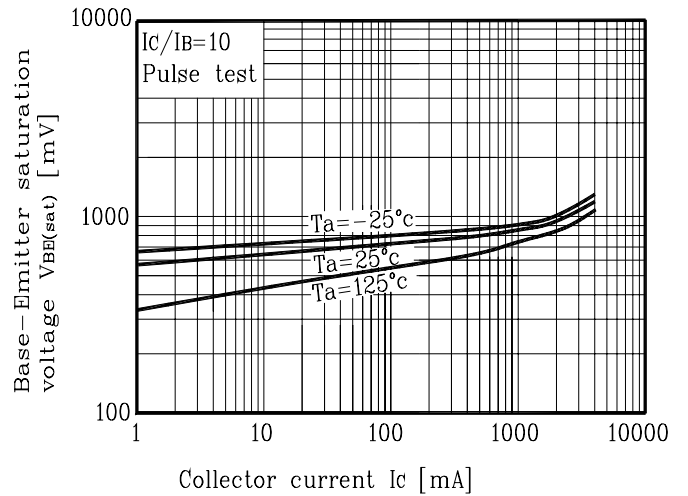

Fig. 6 $V_{BE(sat)} - I_C$



Electrical Characteristic Curves

Fig. 7 Cob - V_{CB}

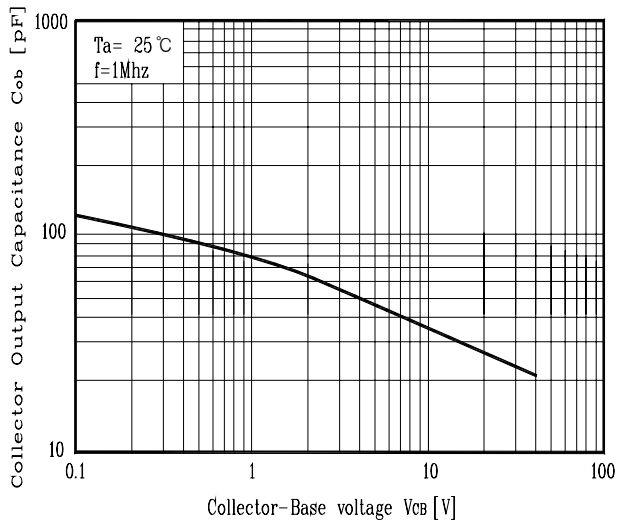
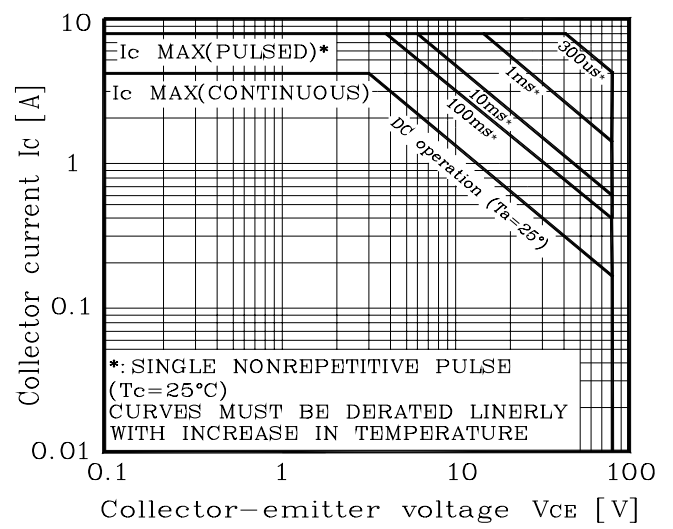
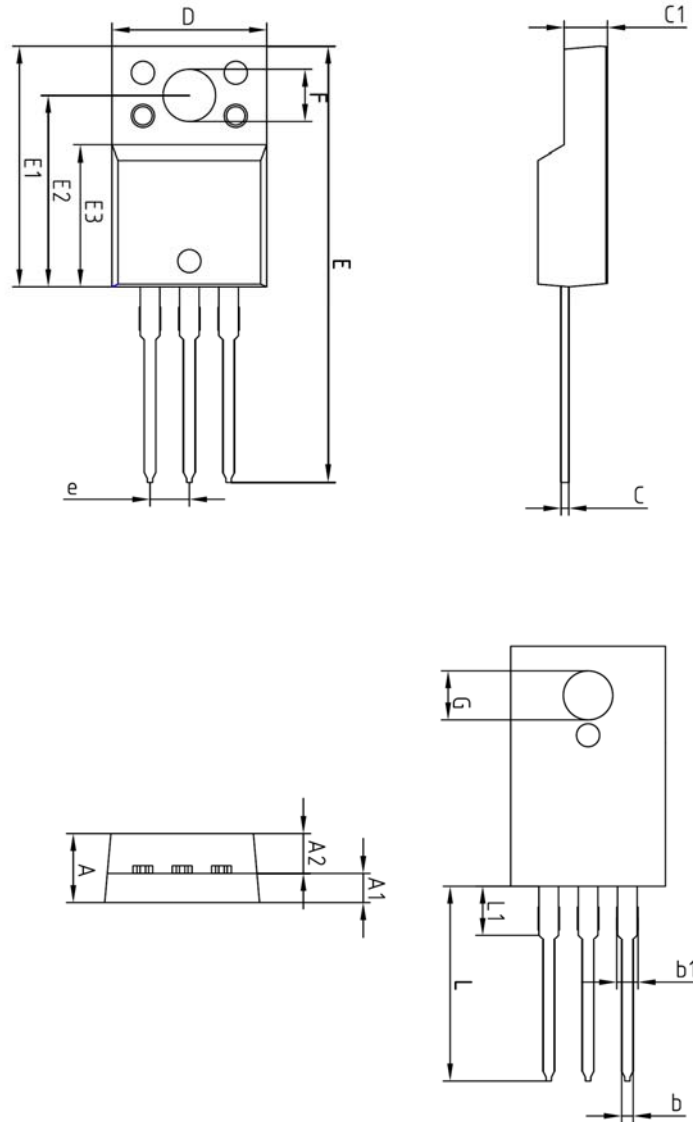

Fig. 8 Safe operating Area



Outline Dimension



SYMBOL	MILLIMETERS			NOTE
	MINIMUM	NOMINAL	MAXIMUM	
A	-	-	4.60	
A1	2.45	2.50	2.55	
A2	1.95	2.00	2.05	
b	0.65	0.75	0.85	
b1	1.07	1.27	1.47	
C	0.40	0.50	0.60	
C1	2.70	2.80	2.90	
D	9.90	10.00	10.10	
E	28.00	-	28.60	
E1	15.50	15.60	15.70	
E2	12.30	12.40	12.50	
E3	9.15	9.20	9.25	
F	3.30	3.40	3.50	
G	3.10	3.20	3.30	
e	2.54 BSC			
L	12.40	-	13.00	
L1	3.46 BSC			

The AUK Corp. products are intended for the use as components in general electronic equipment (Office and communication equipment, measuring equipment, home appliance, etc.).

Please make sure that you consult with us before you use these AUK Corp. products in equipments which require high quality and / or reliability, and in equipments which could have major impact to the welfare of human life(atomic energy control, airplane, spaceship, transportation, combustion control, all types of safety device, etc.). AUK Corp. cannot accept liability to any damage which may occur in case these AUK Corp. products were used in the mentioned equipments without prior consultation with AUK Corp..

Specifications mentioned in this publication are subject to change without notice.