

## Three phase and neutral - high performance

This three phase and neutral filter series provides a high level of attenuation across a broad frequency spectrum. The filter housing's small footprint and option of flange of M5 captive nut mounting, ensures ease of installation within manufactures original equipment. The AB series is particularly suited for UPS, switch mode power supplies, industrial control systems and other such applications.

- Current ratings from 25A to 63A
- Choice of performance options
- High symmetric and asymmetric attenuation
- Screw or terminal block connectors
- Compact enclosure styles
- Captive nut or flange mounting designs

## Mechanical Specifications

Manufacture: tin-plate case with captive nut M5 for mounting, on D3025A, 36A, 50A, 63A with mounting flanges on D4036A, 50A electrical components sealed with resin.

Connections: threaded bar with metric nut M6;  
D4036A with terminal blocks to accept 10mm<sup>2</sup> cable.  
D4050A with terminal blocks to accept 25mm<sup>2</sup> cable.



## Electrical Specifications

Rated voltage ( $V_R$ ): max 440V (ph-ph), 50/60Hz

Rated current ( $I_R$ ): referred to room temperature = 40°C

Leakage current ( $I_L$ ): at  $V_R / \sqrt{3}$ , 50Hz, max value

Voltage test (2 s.): line to ground 2700Vdc  
line to line 1075Vdc

Climatic category: HPF (25/085/21);

Temperature range: -25°C to +85°C

## Filter Range

FLLD3 series AB type Code	$I_R$ (A)	$L_1$ (mH)	$C_{X1}$ ( $\mu$ F)	$C_{X2}$ ( $\mu$ F)	$C_{Y1}$ (pF)	$C_{Y2}$ (pF)	$I_L$ (mA)	R (M $\Omega$ )	Case
FLLD3025AAB01	25	4x1.2	3x2.2	3x2.2	2x15000		<3.2	3x0.47	B
FLLD3036AAB01	36	4x0.95	3x2.2	3x2.2	2x15000		<3.2	3x0.1	A
FLLD4036AAB03	36	4x1.3	3x2.2	3x2.2	2x15000		<3.2	3x0.1	D
FLLD3050AAB01	50	4x2.0	3x2.2	3x2.2	2x15000		<3.2	3x0.47	B
FLLD4050AABR3	50	4x0.5	3x2.2	3x2.2	2x22000	3x4700	<6.1	3x0.1	E
FLLD3063AAB01	63	4x0.7	3x2.2	3x2.2	2x15000		<3.2	3x0.47	B
FLLD3063AAB08	63	4x0.7	3x2.2	3x2.2	2x15000		<3.2	3x0.47	C

\* other variants on request

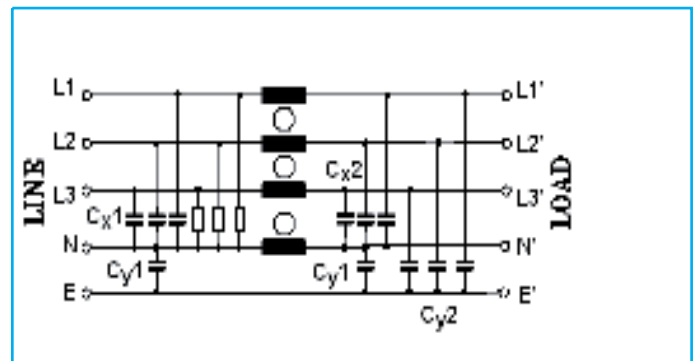

Insertion loss (typical): Asymmetrical (line to ground)

Insertion loss (typical): Symmetrical (line to line)

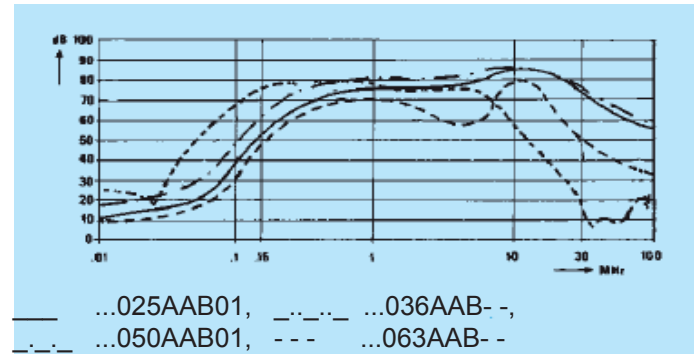
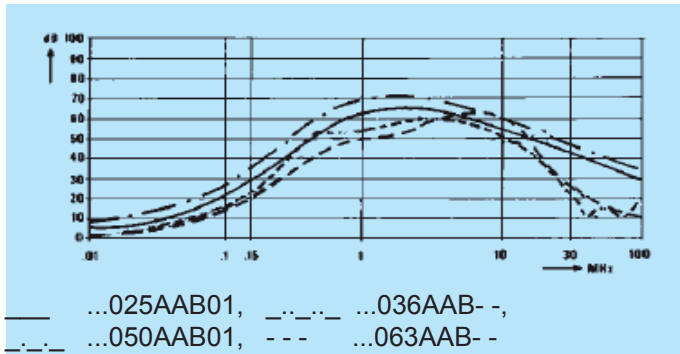

Insertion loss (typical): — Asymmetrical (line to ground)      - - - Symmetrical (line to line)

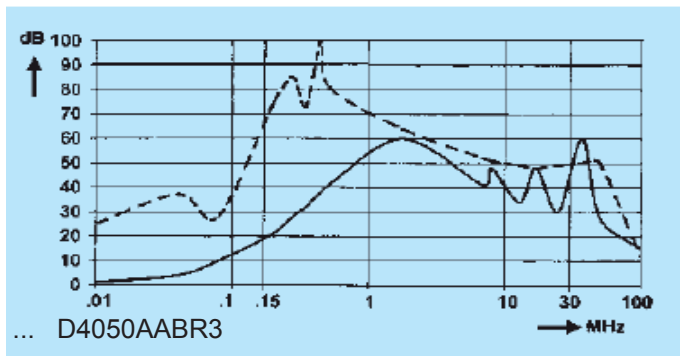

## Dimensions (mm) and connections

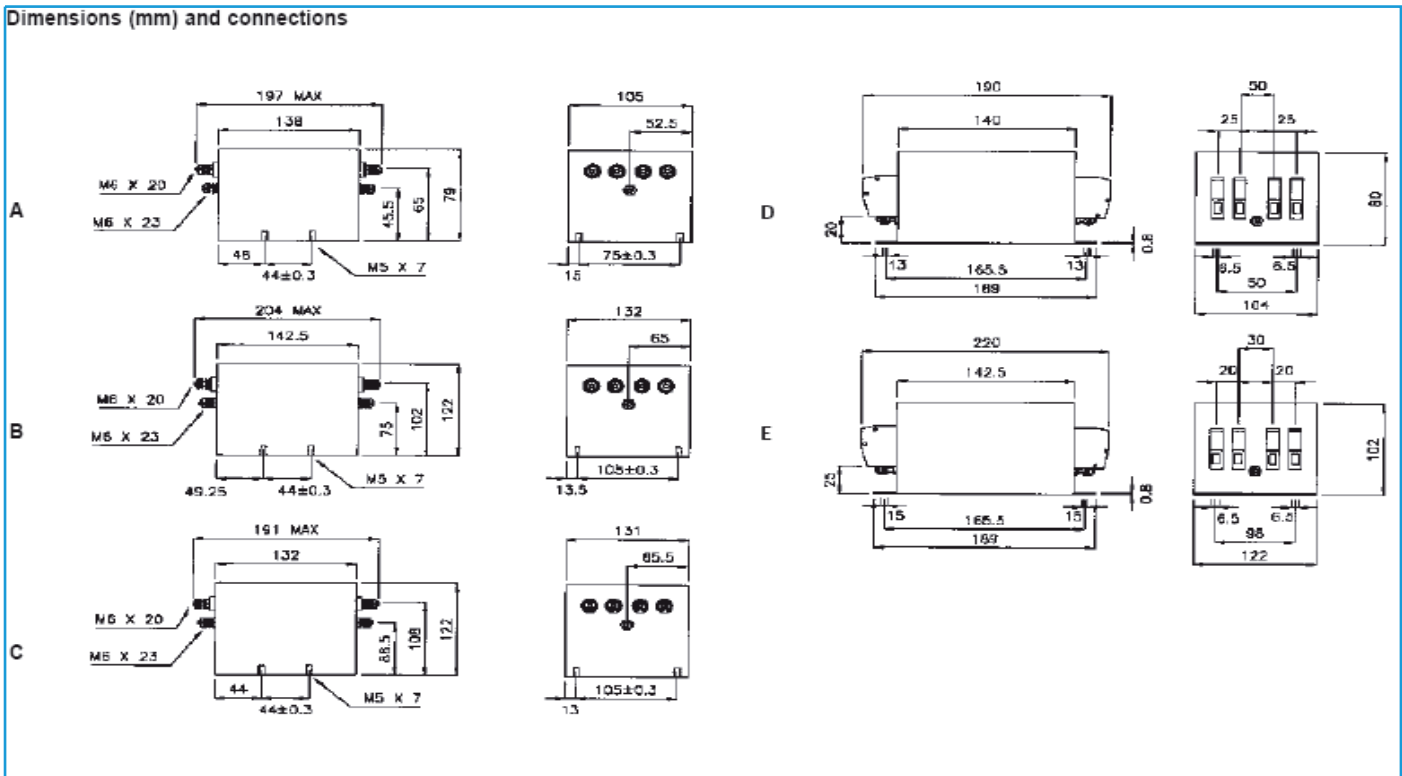

## Three phase and neutral - general performance

This three phase and neutral filter series provides a good level of attenuation across a broad frequency spectrum. The filter housing's small footprint and low-profile ensures ease of installation within manufactures original equipment.

The AD series is particularly suited for UPS, switch mode power supplies, industrial control systems and other such applications.

- Current ratings from 16A to 25A
- High symmetric and asymmetric attenuation
- Screw or fast-on termination
- Low-profile and compact enclosure
- Captive nut mounting

## Mechanical Specifications

Manufacture: metal case; captive nut M5 for mounting, electrical components sealed with self-extinguishing resin.

Connections: faston 6.3 x 0.8mm (16A), threaded bar with metric nut M4 (25A).



## Electrical Specifications

Rated voltage ( $V_R$ ): max 440V (ph-ph), 50/60Hz

Rated current ( $I_R$ ): referred to room temperature = 40°C

Leakage current ( $I_L$ ): at  $V_R / \sqrt{3}$ , 50Hz, max value

Voltage test (2 s.): line to ground 2700Vdc  
line to line 1700Vdc

Climatic category: HPF (25/085/21);

Temperature range: -25°C to +85°C

## Filter Range

FLLD3 series AD type Code	$I_R$ (A)	$L_1$ (mH)	$C_{X1}$ ( $\mu$ F)	$C_{X2}$ ( $\mu$ F)	$C_{Y1}$ (pF)	$C_{Y2}$ (pF)	$I_L$ (mA)	R (M $\Omega$ )	R (M $\Omega$ )
FLLD3016AAD01	16	4 x 1.8	3 x 1	3 x 1	15000	15000	<3.2	3 x 0.33	0.62
FLLD3025AAD01	25	4 x 1.1	3 x 1	3 x 1	15000	15000	<3.2	3 x 0.33	0.62

\* other variants on request

Insertion loss (typical): Asymmetrical (line to ground)

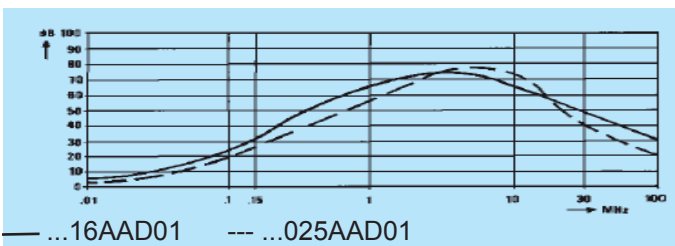

Insertion loss (typical): Asymmetrical (line to ground)

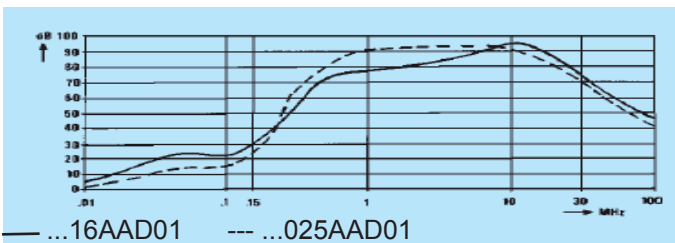

## Dimensions (mm) and connections

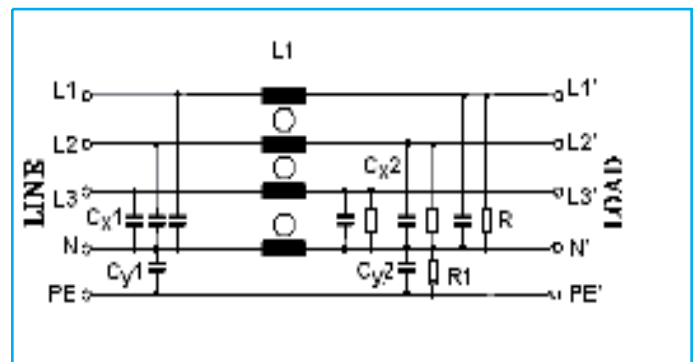
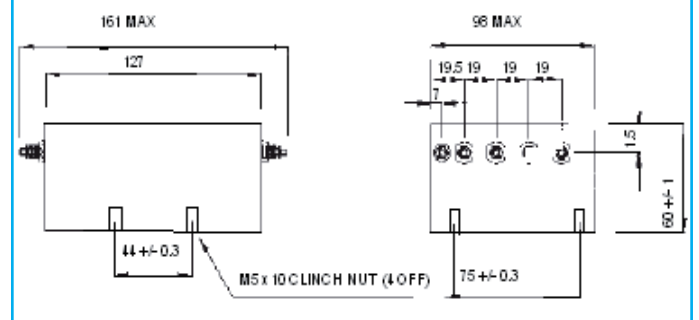

## Approvals

Made in accordance to VDE, UL and CSA requirements

### Three phase and neutral - general purpose

This three phase and neutral filter series provides a cost-effective level of suppression within a compact enclosure. The filter housing's small footprint and low-profile ensures ease of installation within manufactures original equipment.

The AW series is designed to suit a wide variety of general purpose power applications, equipment cabinets and industrial control systems.

- Current ratings from 3A to 20A
- Good high frequency attenuation
- Screw and fast-on termination styles
- Low-profile and compact enclosure

### Mechanical Specifications

Manufacture: metal enclosure;  
electrical components sealed with self-extinguishing resin.

Connections: faston 6.3 x 0.8mm (3A to 10A)  
M4 threaded studs (20A).



### Electrical Specifications

Rated voltage ( $V_R$ ): max 440V, 50/60Hz  
 Rated current ( $I_R$ ): referred to room temperature = 40°C  
 Leakage current ( $I_L$ ): at  $V_R / \sqrt{3}$ , 50Hz, max value  
 Voltage test (2 s.): line to ground 2700Vdc  
 line to line 1075Vdc  
 Climatic category: HPF (25/085/21);  
 Temperature range: -25°C to +85°C

### Filter Range

FLLD3 series AW type Code	$I_R$ (A)	$L_1$ (mH)	$C_x$ ( $\mu$ F)	$C_{y2}$ (pF)	$I_L$ (mA)
FLLD3003AAW03	3	4x0.25	3x0.1	22000	2.3
FLLD3003AAW04	3	4x0.45	3x0.1	4700	0.5
FLLD3006AAW04	6	4x0.45	3x0.1	4700	0.5
FLLD3010AAW01	10	4x1.5	3x0.1	22000	2.3
FLLD3010AAW02	10	4x0.2	3x0.1	4700	0.5
FLLD3020AAW01	20	4x0.25	3x0.1	22000	2.3

\* other variants on request

### Dimensions (mm) and connections

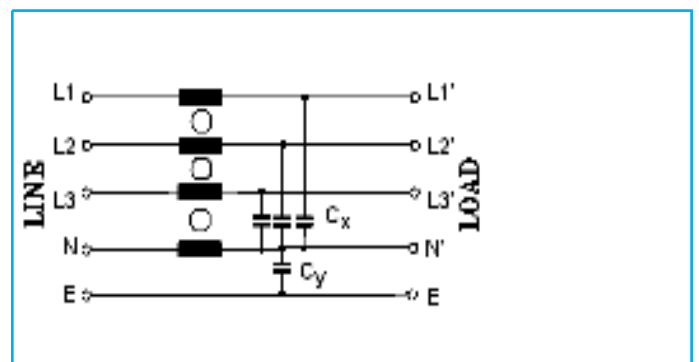
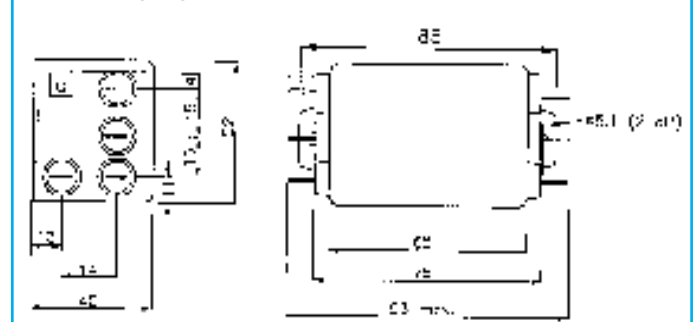

Insertion loss (typical): — Asymmetrical (line to ground)    - - - Symmetrical (line to line)

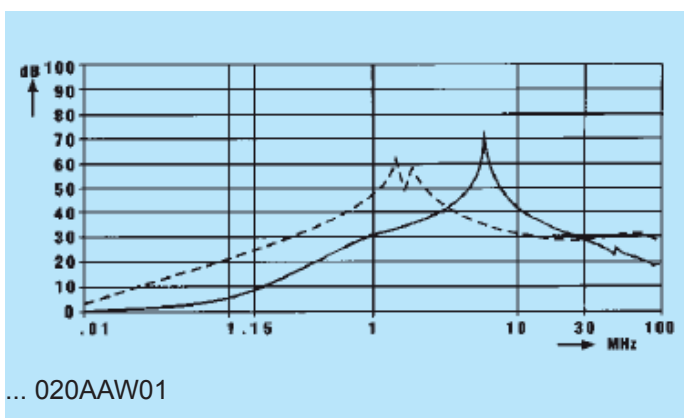
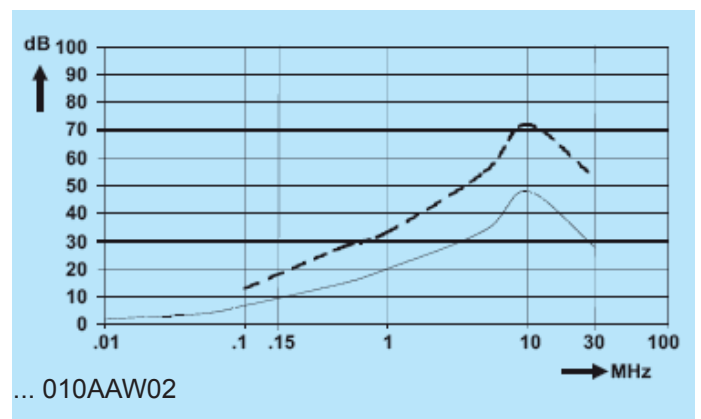
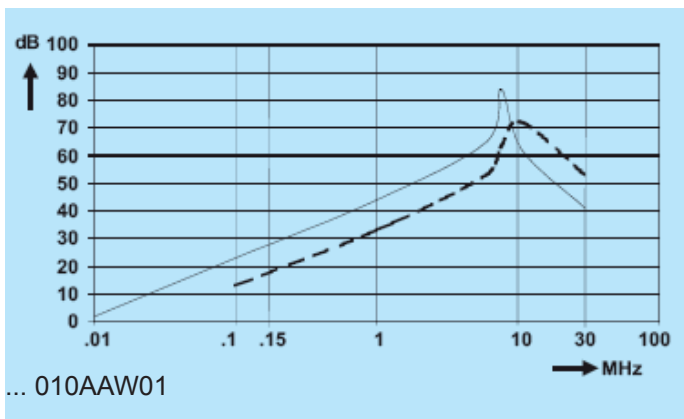
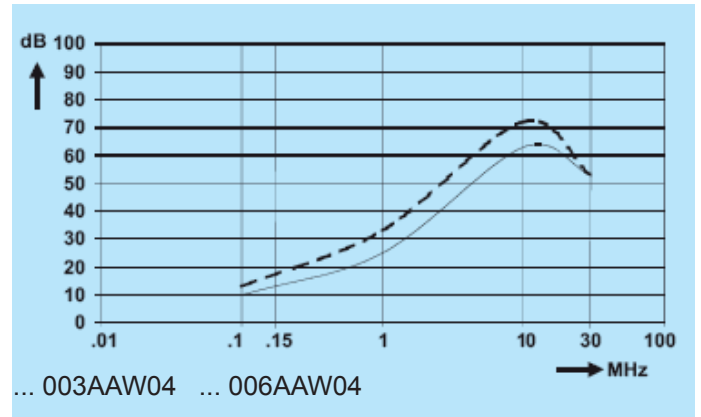
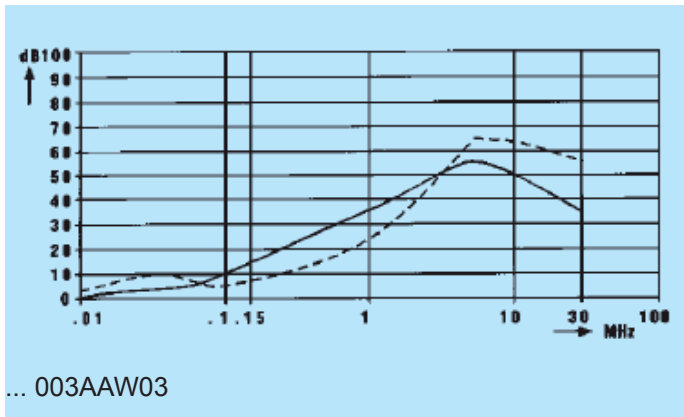

## Three phase and neutral - high performance

This family of three phase or three phase and neutral filters offer high attenuation across a broad frequency spectrum. The single or two stage designs are housed in compact enclosures to assist where space is a premium.

Designed to protect against high levels of interference generated by switch mode power supplies, frequency converters, process machines and industrial power applications.

- Current ratings from 4A to 25A
- Three phase or three phase and neutral options
- High symmetric and asymmetric attenuation
- Good broadband-frequency attenuation
- Compact, low profile enclosures
- Low-leakage versions available



## Mechanical Specifications

Manufacture: case tin-plate steel; electrical components sealed with resin.

Connections: faston 6.3 x 0.8mm (4A, 6A, 10A, 12A); threaded bar with metric nut (20A, 25A).

## Electrical Specifications

Rated voltage ( $V_R$ ): max 440V (ph-ph), 50/60Hz

Rated current ( $I_R$ ): referred to room temperature = 40°C

Leakage current ( $I_L$ ): at  $V_R / \sqrt{3}$ , 50Hz, max value

Voltage test (2 s.): line to ground 2700Vdc

line to line 1700Vdc

Climatic category: HPF (25/085/21);

Temperature range: -25°C to +85°C

## Filter Range

FLLD3 series BM ZS type Code	$I_R$ (A)	$L_1$ (mH)	$L_2$ (mH)	$C_{x1}$ ( $\mu$ F)	$C_{x2}$ ( $\mu$ F)	$C_{y1}$ (nF)	$C_{y2}$ (nF)	$L_L$ (mA)	R (M $\Omega$ )	$R_1$ (M $\Omega$ )	Circ diag
FLLD3004AZSB1	4	3x8	3x0.21	3x1	3x1		3x10	3.2	3x0.33	1	A
FLLD3006AZSB1	6	3x6.5	3x0.12	3x1	3x1		3x10	3.2	2x0.33	1	A
▲ FLLD3006ABM06	6	4x2		3x1.5	3x1.5	1x22	1x22	4.6	3x0.47		E
FLLD3010AZSB1	10	3x4	3x0.57	3x1	3x1		3x10	3.2	3x0.33	1	A
FLLD3012ABM01	12	4x1.7	4x1.7		3x1	4x47	4x47	39.6	3x0.33		B
FLLD3012ABM02	12	4x1.56	4x0.04	3x1	3x1		4x33	13.9	3x0.33	0.62	C
FLLD3020AZS11	20	3x2.5	3x2.5	3x6.6	3x13.2		3x33	10.4	3x0.33	0.62	D
FLLD3025AZS11	25	3x1.5	3x1.5	3x6.6	3x13.2		3x22	7.0	3x0.33	0.62	D

\* other variants on request

## Dimensions (mm) and connections

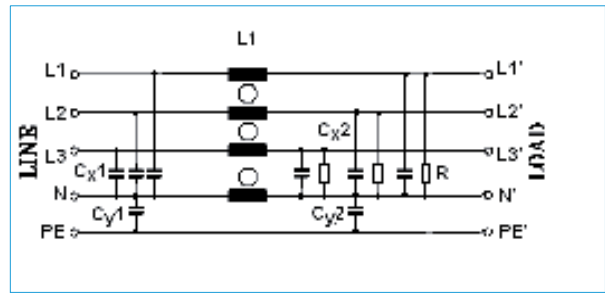
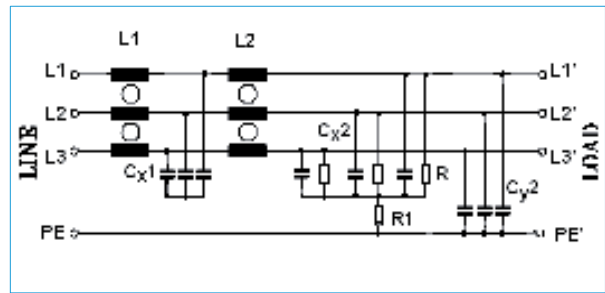
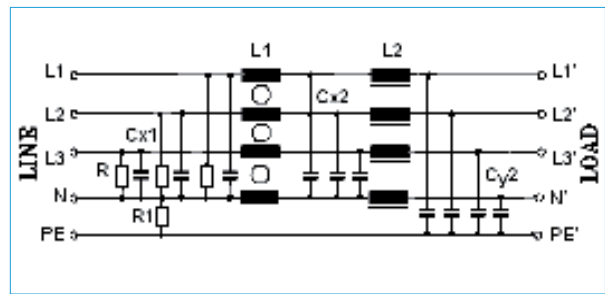
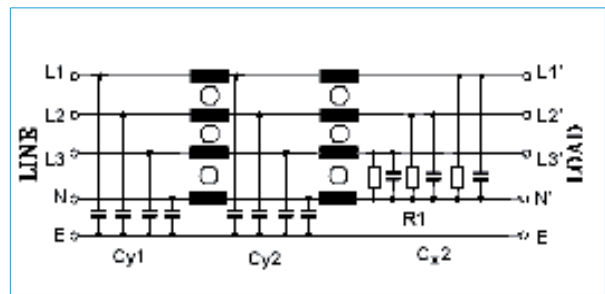
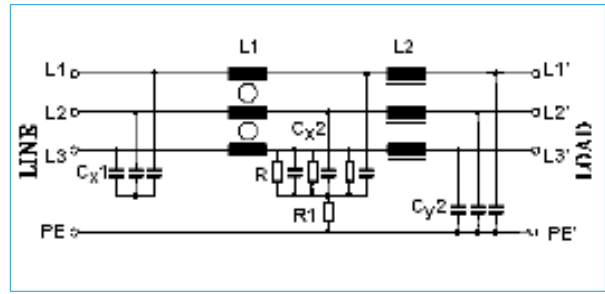
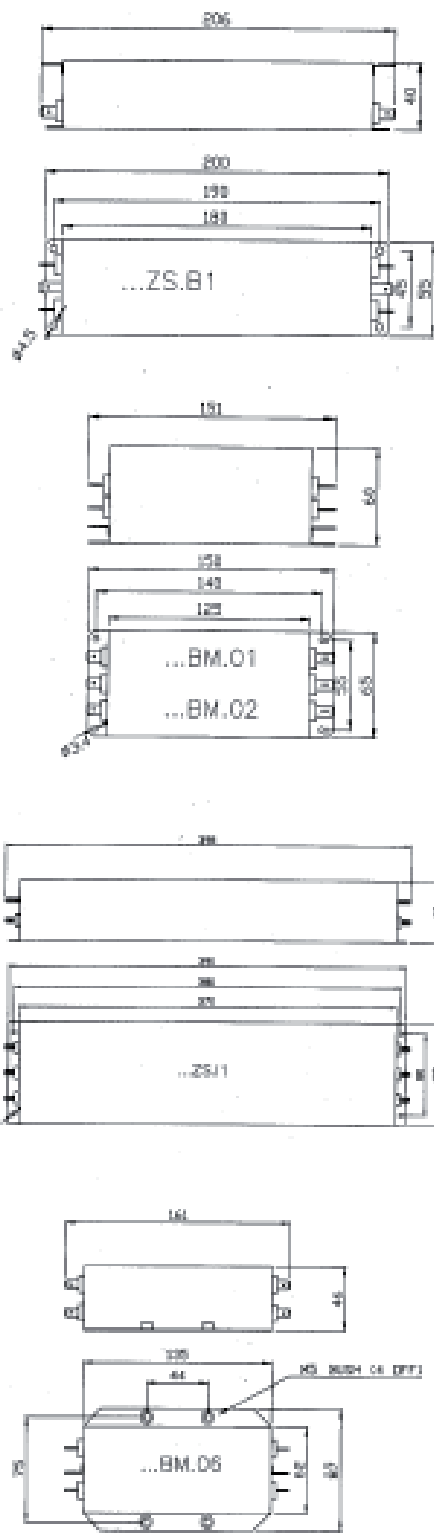

Insertion loss (typical): — Asymmetrical (line to ground)    - - - Symmetrical (line to line)

