

**HIGH EFFICIENCY POWER SCHOTTKY RECTIFIER****MBR3045C****General Description**

High efficiency dual Schottky rectifier suited for switch mode power supplies and other power converters. This device is intended for use in medium voltage operation, and particularly, in high frequency circuits where low switching losses and low noise are required.

MBR3045C is available in TO-220-3, TO-220-3 (2) and TO-220F-3 packages.

**Features**

- Low Forward Voltage: 0.57V @ 125°C
- Low Power Loss/High Efficiency
- 150°C Operating Junction Temperature
- 30A Total (15A Each Diode Leg)
- Guard-ring for Stress Protection
- High Surge Capacity
- Pb-free Package

**Applications**

- Power Supply Output Rectification
- Power Management
- Instrumentation

**Main Product Characteristics**

$I_{F(AV)}$	2×15A
$V_{RRM}$	45V
$T_J$	150°C
$V_F(max)$	0.57V

**Mechanical Characteristics**

- Case: Epoxy, Molded
- Epoxy Meets UL 94V-0 @ 0.125in.
- Weight (Approximately): 1.9Grams
- Finish: All External Surfaces Corrosion Resistant and Terminal
- Leads are Readily Solderable
- Lead Temperature for Soldering Purposes: 260°C Maximum for 10 Seconds

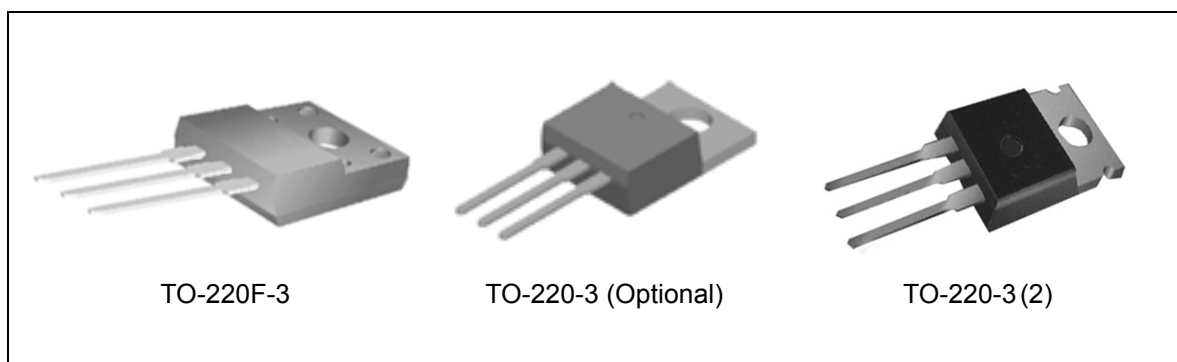

Figure 1. Package Types of MBR3045C

**Pin Configuration**

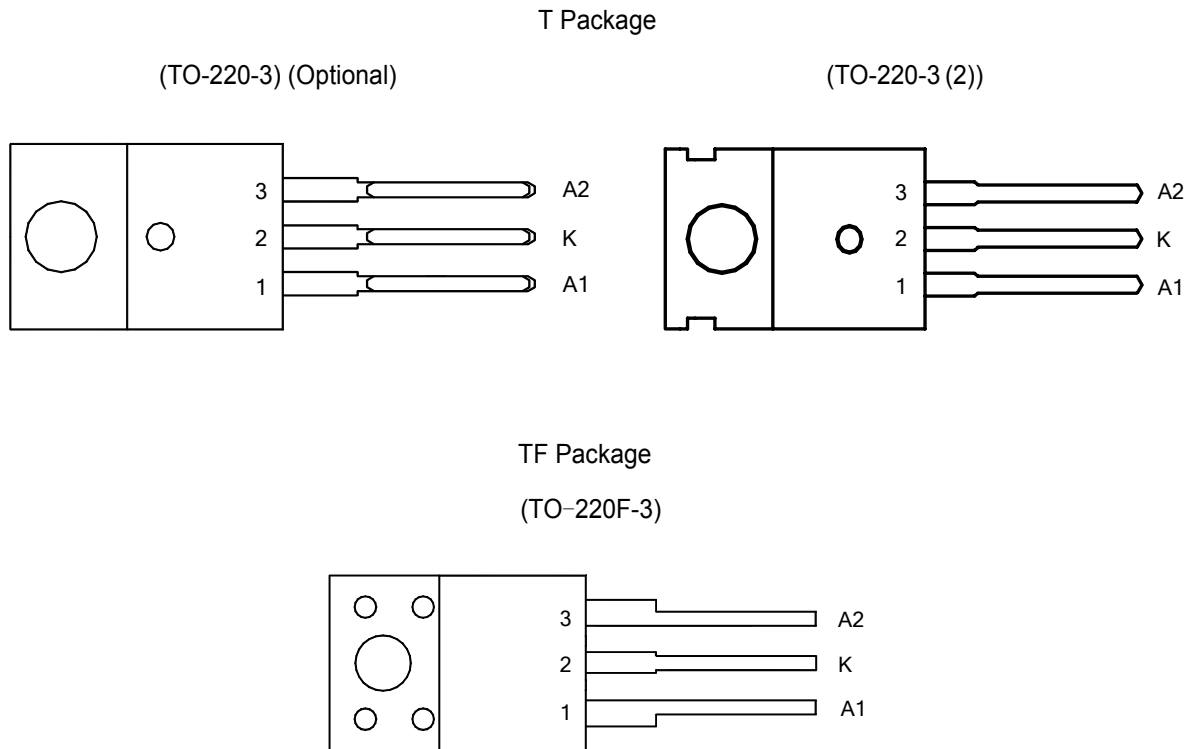

Figure 2. Pin Configuration of MBR3045C (Top View)

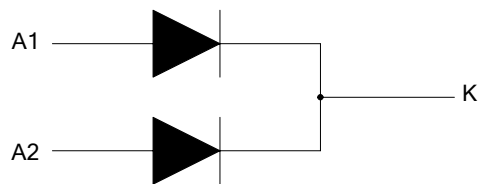

Figure 3. Internal Structure of MBR3045C



**HIGH EFFICIENCY POWER SCHOTTKY RECTIFIER**

**MBR3045C**

**Ordering Information**

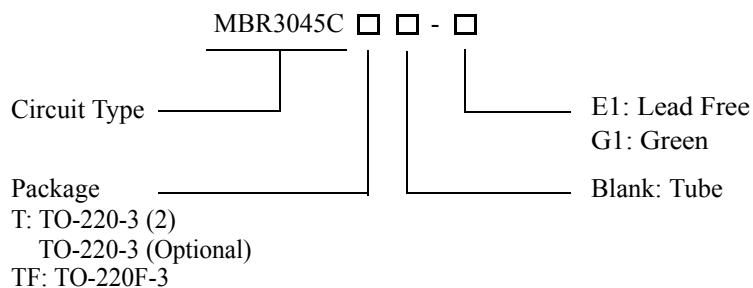

Package	Part Number		Marking ID		Packing Type
	Lead Free	Green	Lead Free	Green	
TO-220-3 (2)	MBR3045CT-E1	MBR3045CT-G1	MBR3045CT-E1	MBR3045CT-G1	Tube
TO-220F-3	MBR3045CTF-E1	MBR3045CTF-G1	MBR3045CTF-E1	MBR3045CTF-G1	Tube

BCD Semiconductor's Pb-free products, as designated with "E1" suffix in the part number, are RoHS compliant. Products with "G1" suffix are available in green packages.

**HIGH EFFICIENCY POWER SCHOTTKY RECTIFIER****MBR3045C****Absolute Maximum Ratings (Each Diode Leg) (Note 1)**

Parameter	Symbol	Value	Unit
Peak Repetitive Reverse Voltage Working Peak Reverse Voltage DC Blocking Voltage	$V_{RRM}$ $V_{RWM}$ $V_R$	45	V
Average Rectified Forward Current (Rated $V_R$ ) $T_C=126^{\circ}\text{C}$	$I_{F(AV)}$	15	A
Peak Repetitive Forward Current (Rated $V_R$ , Square Wave, 20kHz) $T_C=138^{\circ}\text{C}$	$I_{FRM}$	30	A
Non Repetitive Peak Surge Current (Surge Applied at Rated Load Conditions Half Wave, Single Phase, 60Hz)	$I_{FSM}$	200	A
Operating Junction Temperature (Note 2)	$T_J$	150	$^{\circ}\text{C}$
Storage Temperature Range	$T_{STG}$	-65 to 150	$^{\circ}\text{C}$
Voltage Rate of Change (Rated $V_R$ )	dv/dt	10000	V/ $\mu\text{s}$
ESD (Machine Model=C)		400	V
ESD (Human Body Model=3B)		8000	V

Note 1: Stresses greater than those listed under "Absolute Maximum Ratings" may cause permanent damage to the device. These are stress ratings only, and functional operation of the device at these or any other conditions beyond those indicated under "Recommended Operating Conditions" is not implied. Exposure to "Absolute Maximum Ratings" for extended periods may affect device reliability.

Note 2: The heat generated must be less than the thermal conductivity from Junction to Ambient:  $dP_D/dT_J < 1/\theta_{JA}$ .

**Thermal Characteristics**

Parameter	Symbol	Condition	Value	Unit	
Maximum Thermal Resistance	$\theta_{JC}$	Junction to Case	TO-220-3/ TO-220-3 (2)	3.0	$^{\circ}\text{C}/\text{W}$
			TO-220F-3	2.0	
	$\theta_{JA}$	Junction to Ambient	TO-220-3/ TO-220-3 (2)	60	

**HIGH EFFICIENCY POWER SCHOTTKY RECTIFIER****MBR3045C****Electrical Characteristics (Each Diode Leg)**

Parameter	Symbol	Condition	Value	Unit
Maximum Instantaneous Forward Voltage Drop (Note 3)	$V_F$	$I_F=15A, T_C=25^\circ C$	0.7	V
		$I_F=15A, T_C=125^\circ C$	0.57	
		$I_F=30A, T_C=25^\circ C$	0.84	
		$I_F=30A, T_C=125^\circ C$	0.72	
Maximum Instantaneous Reverse Current (Note 3)	$I_R$	Rated DC Voltage, $T_C=125^\circ C$	20	mA
		Rated DC Voltage, $T_C=25^\circ C$	0.1	

Note 3: Pulse Test: Pulse Width=300 $\mu$ s, Duty Cycle $\leq$ 2.0%.



**Typical Performance Characteristics**

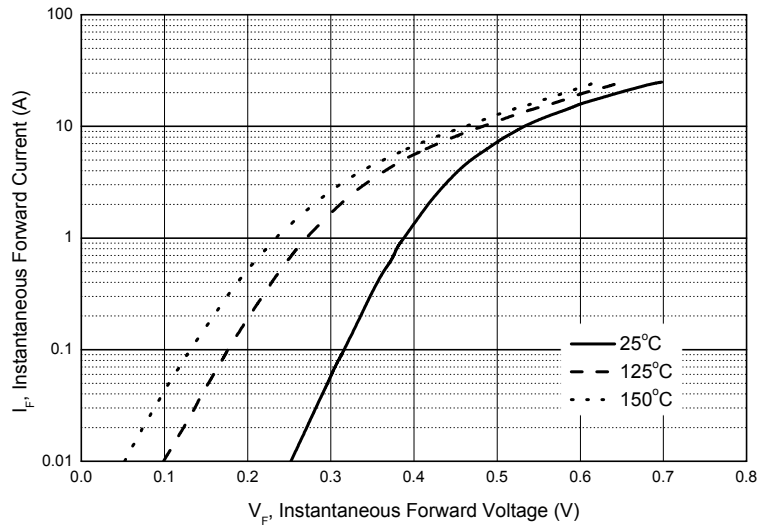

Figure 4. Typical Forward Voltage

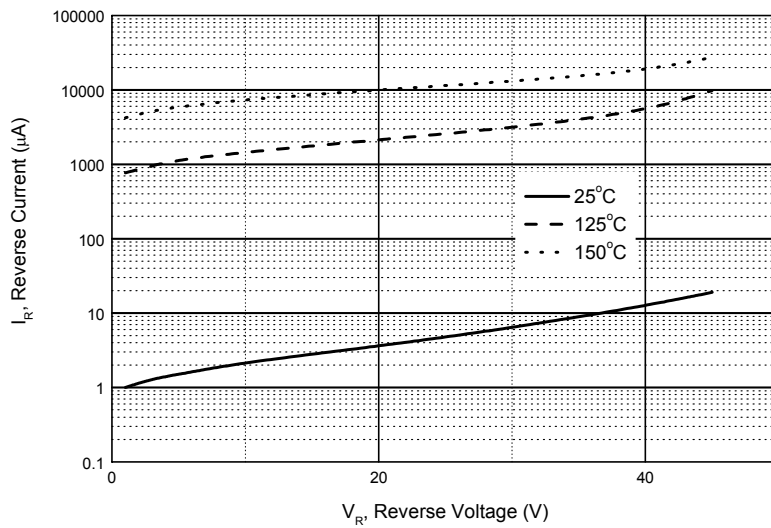

Figure 5. Typical Reverse Current



**Typical Performance Characteristics (Continued)**

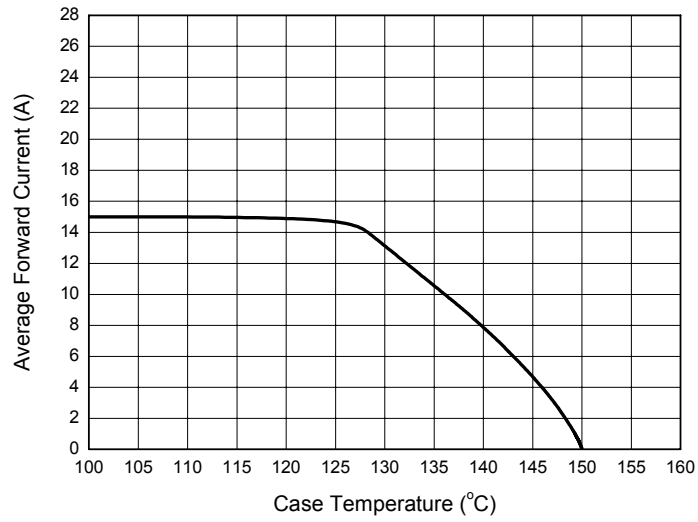

Figure 6. Average Forward Current vs. Case Temperature (Square, Each Diode)



**HIGH EFFICIENCY POWER SCHOTTKY RECTIFIER**

**MBR3045C**

**Mechanical Dimensions**

**TO-220-3**  
(Optional)

**Unit: mm(inch)**

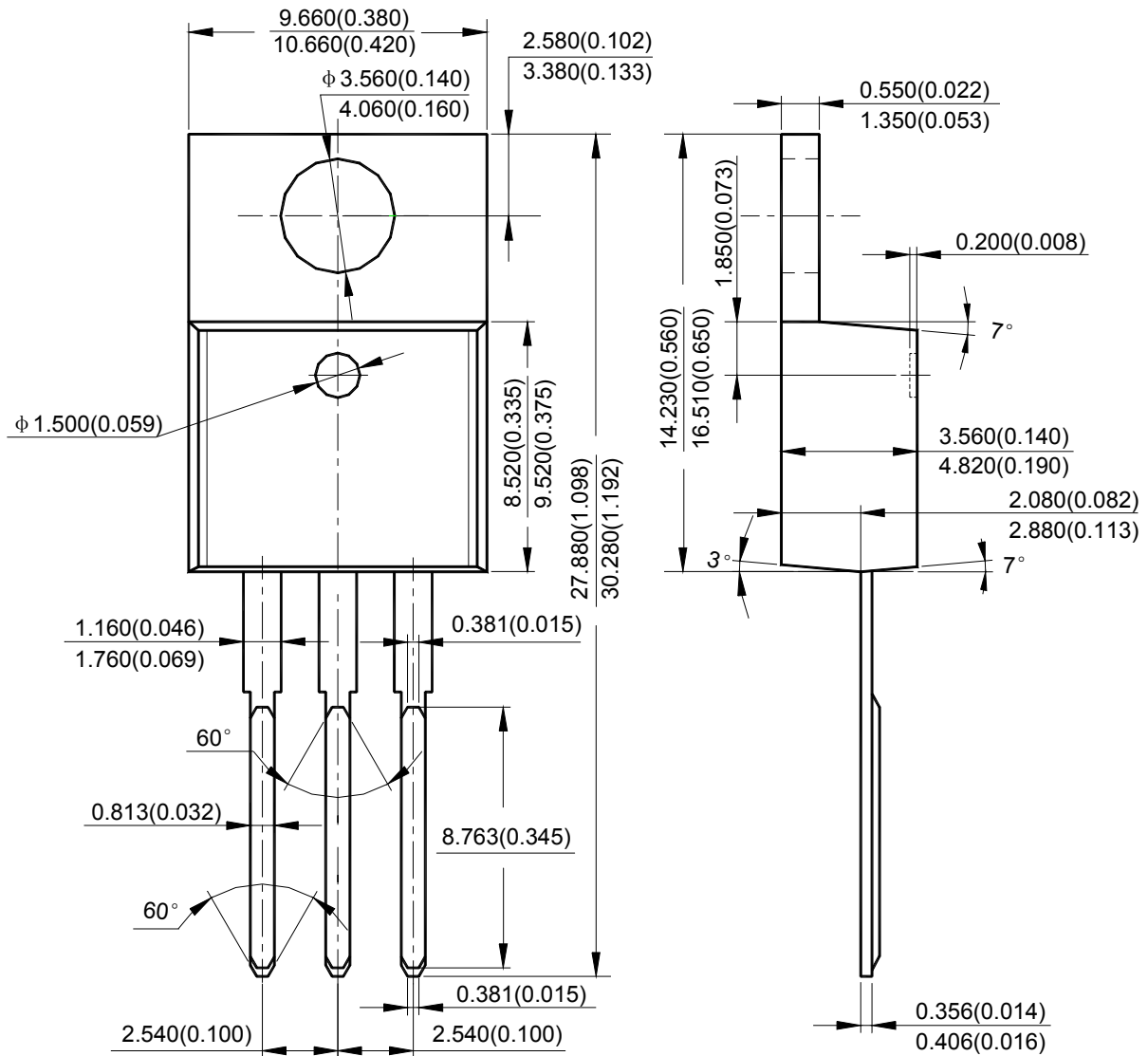





**HIGH EFFICIENCY POWER SCHOTTKY RECTIFIER**

**MBR3045C**

**Mechanical Dimensions (Continued)**

**TO-220-3 (2)**

**Unit: mm(inch)**

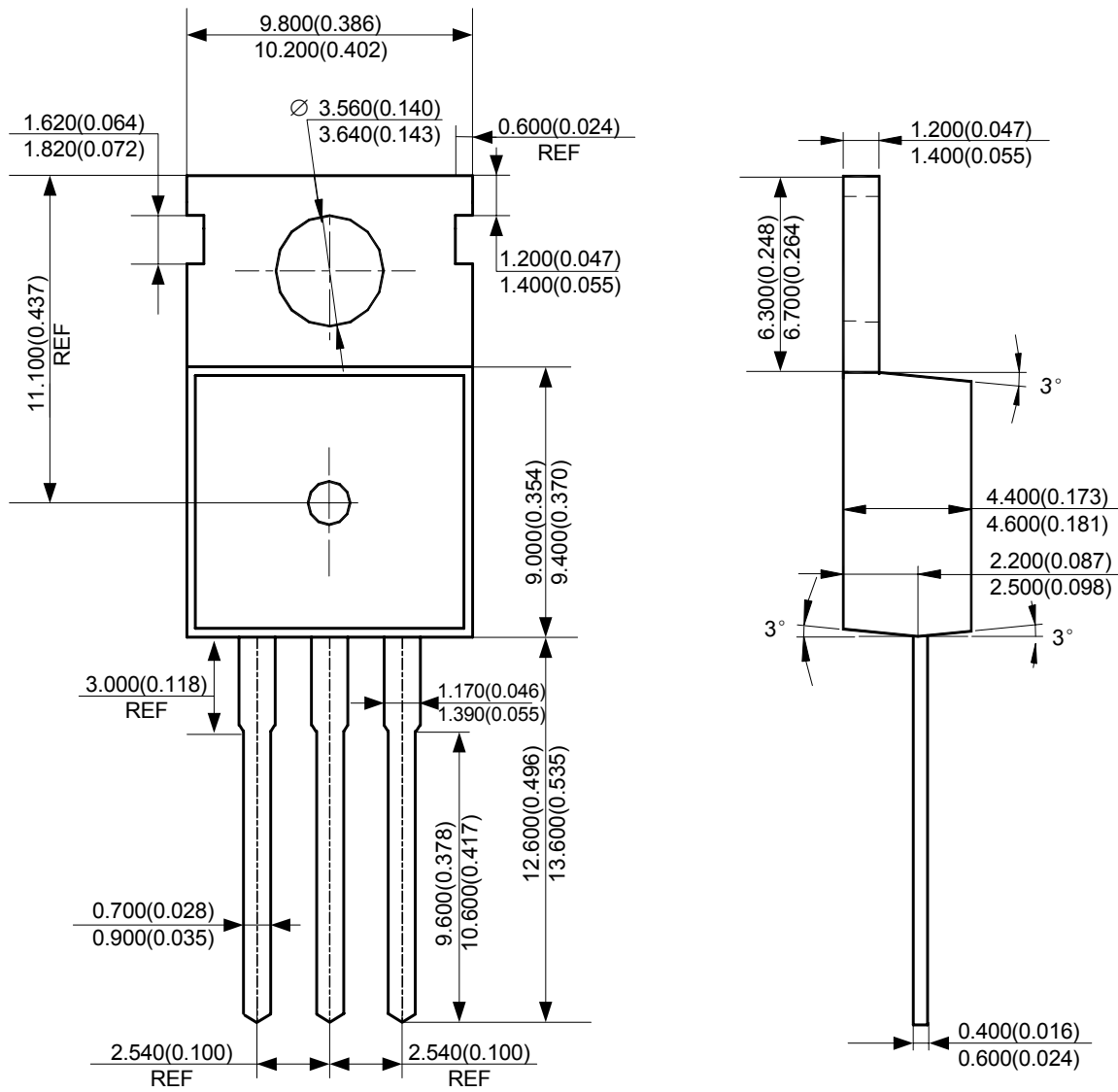



**HIGH EFFICIENCY POWER SCHOTTKY RECTIFIER**

**MBR3045C**

**Mechanical Dimensions (Continued)**

**TO-220F-3**

**Unit: mm(inch)**

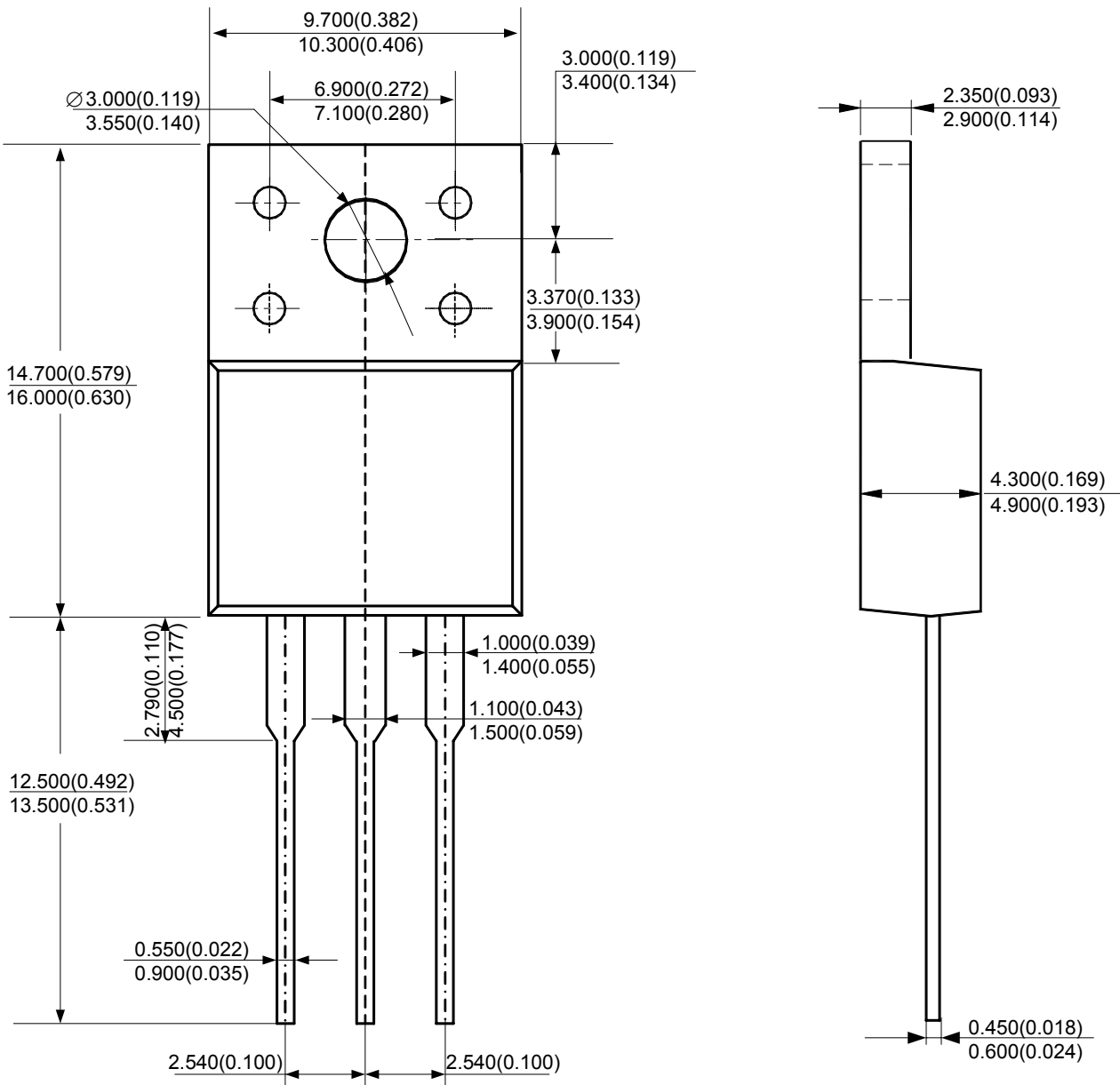



## **BCD Semiconductor Manufacturing Limited**

<http://www.bcdsemi.com>

### **IMPORTANT NOTICE**

BCD Semiconductor Manufacturing Limited reserves the right to make changes without further notice to any products or specifications herein. BCD Semiconductor Manufacturing Limited does not assume any responsibility for use of any its products for any particular purpose, nor does BCD Semiconductor Manufacturing Limited assume any liability arising out of the application or use of any its products or circuits. BCD Semiconductor Manufacturing Limited does not convey any license under its patent rights or other rights nor the rights of others.

---

#### **MAIN SITE**

##### **- Headquarters**

##### **BCD Semiconductor Manufacturing Limited**

No. 1600, Zi Xing Road, Shanghai ZiZhu Science-based Industrial Park, 200241, China  
Tel: +86-21-24162266, Fax: +86-21-24162277

##### **- Wafer Fab**

##### **Shanghai SIM-BCD Semiconductor Manufacturing Co., Ltd.**

800 Yi Shan Road, Shanghai 200233, China  
Tel: +86-21-6485 1491, Fax: +86-21-5450 0008

#### **REGIONAL SALES OFFICE**

##### **Shenzhen Office**

##### **Shanghai SIM-BCD Semiconductor Manufacturing Co., Ltd., Shenzhen Office**

Unit A Room 1203, Skyworth Bldg., Gaoxin Ave. 1.S., Nanshan District, Shenzhen, China  
Tel: +86-755-8826 7951  
Fax: +86-755-8826 7865

##### **Taiwan Office**

##### **BCD Semiconductor (Taiwan) Company Limited**

4F, 298-1, Rui Guang Road, Nei-Hu District, Taipei, Taiwan  
Tel: +886-2-2656 2808  
Fax: +886-2-2656 2806

##### **USA Office**

##### **BCD Semiconductor Corp.**

30920 Huntwood Ave. Hayward, CA 94544, USA  
Tel : +1-510-324-2988  
Fax: +1-510-324-2788