

SHARP

LQ065T9BR51

Color TFT LCD Module

(Model Number: LQ065T9BR51)

Specifications

Spec No.: LCY-00065

Dated: May 31, 2002

PREPARED BY : DATE

S H A R P

SPEC No. LCY-00131

FILE No.

ISSUE : Dec. 1. 2000

APPROVED BY : DATE

TFT LIQUID CRYSTAL DISPLAY GROUP
SHARP CORPORATION

PAGE : 39 pages

APPLICABLE GROUP

TFT LIQUID CRYSTAL DISPLAY
GROUP

S P E C I F I C A T I O N

DEVICE SPECIFICATION FOR

T F T - L C D m o d u l e

M O D E L No. L Q 0 6 5 T 9 B R 5 1

CUSTOMER'S APPROVAL

DATA _____

BY _____

PRESENTED

BY _____

S. YASUDA

DIVISION DEPUTY GENERAL MANAGER

DEVELOPMENT ENGINEERING DEPT. II

TFT DIVISION I

TFT LIQUID CRYSTAL DISPLAY GROUP

SHARP CORPORATION

NOTICE

This publication is the proprietary of SHARP and is copyrighted, with all rights reserved. Under the copyright laws, no part of this publication may be reproduced or transmitted in any form or by any means, electronic or mechanical for any purpose, in whole or in part, without the express written permission of SHARP. Express written permission is also required before any use of this publication may be made by a third party.

The application circuit examples in this publication are provided to explain the representative applications of SHARP's devices and are not intended to guarantee any circuit design or permit any industrial property right or other rights to be executed. SHARP takes no responsibility for any problems related to any industrial property right or a third party resulting from the use of SHARP's devices, except for those resulting directly from device manufacturing processes.

In the absence of confirmation by device specification sheets, SHARP takes no responsibility for any defects that occur in equipment using any of SHARP's devices, shown in catalogs, data books, etc. Contact SHARP in order to obtain the latest device specification sheets before using any SHARP's device.

SHARP reserves the right to make changes in the specifications, characteristics, data, materials, structures and other contents described herein at any time without notice in order to improve design or reliability. Contact SHARP in order to obtain the latest specification sheets before using any SHARP's device. Manufacturing locations are also subject to change without notice.

Observe the following points when using any device in this publication. SHARP takes no responsibility for damage caused by improper use of the devices.

The devices in this publication are designed for use in general electronic equipment designs, such as:

- Personal computers
- Office automation
- Telecommunication equipment
- Test and measurement equipment
- Industrial control
- Audio visual and multimedia equipment
- Consumer electronics

The appropriate design measures should be taken to ensure reliability and safety when SHARP's devices are used for equipment such as:

- Transportation control and safety equipment (i.e., aircraft, trains, automobiles, etc.)
- Traffic signals
- Gas leakage sensor breakers
- Alarm equipment
- Various safety devices etc.

SHARP's devices shall not be used for equipment that requires extremely high level of reliability, such as:

- Military and space applications
- Nuclear power control equipment
- Medical equipment for life support

Contact a SHARP representative, in advance, when intending to use SHARP's devices for any "specific" applications other than those recommended by SHARP.

Contact and consult with a SHARP representative if there are any questions about the contents of this publication.

C O N T E N T S

	Page
(1) Introduction	3
(2) Features	3
(3) Construction and Outline	3
(4) Module geometry	3
(5) Input/Output symbol and description	4
(6) Absolute maximum ratings	9
(7) Electrical characteristics	10
(8) Optical characteristics	15
(9) Mechanical characteristics	18
(10) Display quality	20
(11) Handling instruction	20
(12) Shipping requirements	22
(13) Reliability test items	22
(14) Others	22
Attached Figures	
Fig 1. Outline dimension of TFT-LCD module	24
Fig 2. Construction of TFT-LCD module	25
Fig 3. Packing form	26
Fig 4. Input/Output signal waveforms	27
Fig 5. Measurement method of optical characteristic (Transmissive mode)	36
Fig 6. Measurement method of optical characteristic (Reflective mode)	37
Attached sheet	
(Appendix-1) Adjusting method of common electrode DC bias voltage	38

(1) Summary

The SHARP color TFT-LCD module is an active matrix LCD (Liquid Crystal Display) produced by making the most of Sharp's expertise in liquid-crystal and semiconductor technologies. The active device is amorphous silicon TFT (Thin Film Transistor). The module has a 16:9 aspect ratio and accepts full color video signal conforming to the NTSC and PAL systems. An outline of the module is shown in Table 1.

(2) Features

- 16:9 aspect ratio suitable for the wide-screen systems.
- a variety of display modes can be selected without any loss of wide-screen characteristics
- The 6.5 screen produces a high resolution image that is composed of 96,000 pixel elements in a stripe arrangement.
- Wide viewing angle technology is adopted. (The most suitable viewing angle is in the 6 o'clock direction.)
- External clock synchronization allows an extremely clear image to be displayed.
- TFT-active matrix-LCD drive system with high contrast
- Dual mode type [NTSC (M) and PAL(B · G) standards]
- MBK-PAL which enables the 240-scanning lines panel to display a picture with virtually 274-scanning lines.
- Reduced reflection as a result of low reflectance black matrix and an antiglare (AG) and anti-reflection (AR) polarizer being adopted.
- A thin, lightweight and compact
 - ①Effective area/Outline area= 82% ②Thickness=12.5 mm ③Mass=205g
- Multi scene display which is able to display high-quality color image in all lighting condition
- Through the use of TN-normally white mode, an image with highly natural color reproduction is realized.
- It is possible to reverse the display direction (right/left and up/down).
- Self-heating Backlight that is excellent of brightness rising characteristics at low temperature in consideration of automotive application

(3) Construction and Outline

Outline dimension of TFT-LCD module : Fig. 1 (and the structure of the module is shown in Fig. 2).

The module consists of the TFT-LCD panel, driver ICs, control PWB mounted with electronic circuits, self heating backlight, frame, backlight, front and rear shielding cases.

(4) Mechanical specifications

Table 1

Parameter	Specifications	Units	Remarks
Display format	96,000	pixels	
	1200(W)×240(H)	dots	
Active area	143.4 (W) × 79.326 (H)	mm	
Screen size (Diagonal)	16.5 [6.5"]	cm	
Dot pitch	0.1195 (W) × 0.3305 (H)	mm	
Pixel configuration	R,G,B Stripe configuration		
Outline dimension	155(W)×89.2(H)×12.5(D)	mm	【Note1-1】
Mass	190 ± 10	g	【Note1-2】

【Note1-1】 This measurement is typical, and see Fig. 1 for details.

【Note1-2】 Maximum values are given.

(5)Input/Output terminal and their description

5-1)TFT-LCD panel driving section

Table 2

(H i = VSH, L o = GND)

Pin No.	Symbol	i/o	Description	Remarks
1	HSY	i / o	Input/Output horizontal sync. signal (low active)	【Note2-1】
2	FRPT	o	Polarity alternating signal for common signal	【Note2-2】
3	SYN	i	Composite sync.signal (high active)	
4	VGH	i	Power supply for gate driver (high level)	
5	FRPV	o	Polarity alternating signal for video signal	【Note2-3】
6	VB	i	Color video signal (Blue)	【Note2-4】
7	VR	i	Color video signal (Red)	【Note2-4】
8	VG	i	Color video signal (Green)	【Note2-4】
9	GND	i	Ground	
10	VSH	i	Positive power supply voltage	
11	VGL	i	Power supply for gate driver (low level)	
12	COM	i	Common electrode driving signal	【Note2-5】
13	NTP	i	Selection for NTSC or PAL	【Note2-6】
14	VSY	i / o	Input/Output vertical sync. signal (low active)	【Note2-7】
15	HRV	i	Selection for horizontal scanning direction	【Note2-8】
16	VRV	i	Selection for vertical scanning direction	【Note2-9】
17	CLKC	i	Selection for input/output direction of CLK,HSY,VSY	【Note2-10】
18	PWM	o	Timing signal for PWM dimming of backlight	【Note2-11】
19	VMSW	I	Selection for number of vertical line	【Note2-12】
20	CLK	i / o	Input/output clock signal	【Note2-13】
21	MODS	i	Selection for display mode	【Note2-14】
22	MODW	i	Selection for display mode	【Note2-14】
23	MODN	i	Selection for display mode	【Note2-14】
24	VCS	o	Video selection timing signal	【Note2-15】

【Note2-1】 If CLKC="Hi", this terminal outputs horizontal sync. signal synchronized with the SYN signal. If CLKC="Lo", this terminal will be external horizontal sync. input terminal.

【Note2-2】 This terminal is to reverse the polarity of common electrode driving signal (COM).

【Note2-3】 This terminal is to reverse the polarity of video signal. Use of a dedicated video signal polarity reversing IC should be used. Recommended interface ICs to be reversed the polarity of video signal are the IR3Y26A (analog RGB input type) and IR3Y29BM (composite video type) manufactured by Sharp.

【Note2-4】 This terminal is to be input the video signal which whose polarity is reversed in compliance with the FRPV inverse timing signal.

【Note2-5】 This terminal is to be input the common electrode driving signal (COM) whose polarity is reversed in compliance with the FRPV inverse timing signal. Brightness is adjusted through a change of the COM signal amplitude, and the center position of the COM input signal (VDC) is adjusted, maximum contrast for a module's display screen should be achieved.

【Note2-6】 NTP = "Hi": NTSC system

NTP = "Lo": PAL system

【Note2-7】 When CLKC="Hi", this terminal outputs vertical sync. signal synchronized with the SYN signal. When CLKC="Lo", this terminal will be external horizontal sync. input terminal.

【Note2-8】 HRV = "Hi": Normal video

HRV = "Lo": Reversed video on horizontal direction

【Note2-9】 VRV = "Hi": Normal video

VRV = "Lo": Reversed video on vertical direction

【Note2-10】 CLCK = "Hi": CLK, HSY and VSY terminals are the output mode.

CLCK = "Lo": CLK, HSY and VSY terminals are the input mode.

- 【Note2-11】** PWM signal is used for the PWM dimming frequency and it is possible to control the PWM signal dimming by combining both HSY and PWM signal. But, please use this PWM signal just in case of inputting standard NTSC or PAL signal. (See Fig. 4 – 1)
- 【Note2-12】** VMSW = “Hi”: Vertical 240 line display
VMSW = ‘Lo”: Vertical 234 line display
Masking signal for upper 1 line and bottom 5 line is output with VCS signal.
- 【Note2-13】** When CLKC="Hi", this terminal outputs low level.
When CLKC="Lo", this terminal will be external clock input terminal.
This signal should correspond to sampling timing of the horizontal direction image. NTP, MODS, MODW, and MODN should be "Hi" when CLKC="Lo".
- 【Note2-14】** Display mode settings are shown in Table 3.
- 【Note2-15】** In case of normal mode (MODS="Hi", MODW="Lo", MODN="Hi"), it is possible to get an excellent display by masking of video signal based on the VCS output signal. The video signal is masked when VCS is "Hi" (the two edges of the screen). (In case of black masking display, it is possible to easily get the normal screen (full frame) by inputting the VCS signal at the system switching terminal of the video interface IC, inputting the field signal into another video input and inputting a signal for black into the other video input.
And also, in case of vertical 234 lines, the masking signal of upper 1 line and bottom 5 lines is output regardless of display mode.
In case of the other condition except above, the output of VCS becomes “Lo”.
In case of the module test mode, the test signal is output.

Table 3 Display Method and Characteristics

MODS	MODW	MODN	Display mode	Characteristics	Source	example
H	H	H	Full mode	The picture is displayed with uniform enlargement in the horizontal direction, and the horizontal retrace line of the input signal cannot be seen. If the video sampling frequency of the image is fixed and a 4:3 video signal is displayed, the picture will be prominently oblong.	4:3 signal, Navigation signal	Fig.3-1
H	H	L	Wide mode 1	A 4:3 video signal is displayed with less feeling of incongruity than that in the full screen mode. Since the video horizontal sampling frequency is modulated in the horizontal direction, the degree of perfect roundness in the center of the screen is improved over that of the full screen mode.	4:3 signal	Fig.3-2
H	L	H	Normal mode	When displaying a 4:3 video signal, the displayed image is slightly less than perfectly round and the horizontal retrace line period is displayed at the two edges of the screen. With respect to the video horizontal sampling frequency, the center portion of the screen is slightly lower and the two edges become slightly higher. With respect to the horizontal retrace line period, a far better display is achieved than that of masking of the video signal by the VCS signal timing.	4:3 signal	Fig.3-3
H	L	L	Cinema mode	A letter-box type image (16:9 signal) is displayed over the central width of the screen. In the horizontal direction, full screen display is utilized. Due to the display being extended in the vertical direction, a slightly less than perfectly round image is displayed.	letter box type wide signal(16:9signal)	Fig.3-4
L	H	H	Wide mode 2	In the horizontal direction, the Wide 1 display mode is employed. Due to the display being extended in the vertical direction, the portion of the picture in the center of the screen is slightly less than perfectly round. Also due to extending in the vertical direction, the upper and lower portions of the image are not displayed.	4:3 signal	Fig.3-5
L	H	L	test	This mode is unusable as it is the test mode.	—	—
L	L	H	test	This mode is unusable as it is the test mode.	—	—
L	L	L	test	This mode is unusable as it is the test mode.	—	—

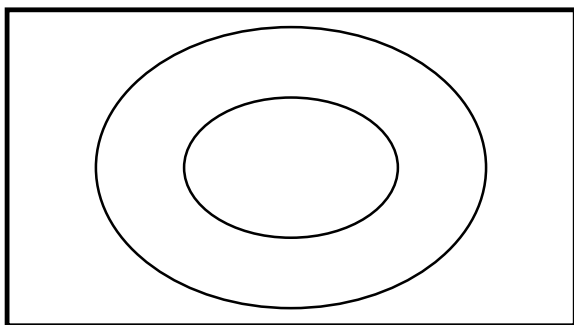

Fig.3-1 Full mode

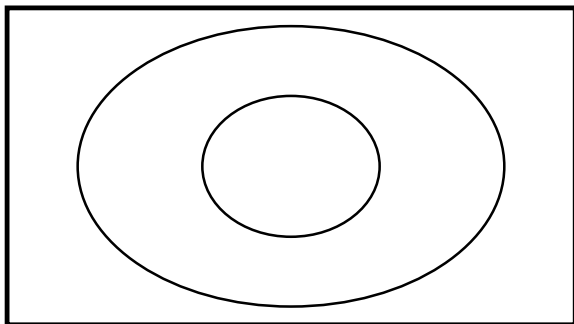

Fig.3-2 Wide 1 mode

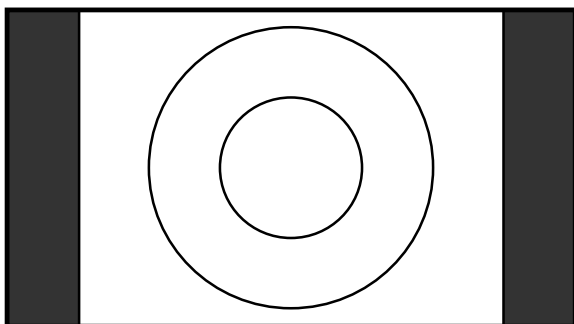

Fig.3-3 Normal mode

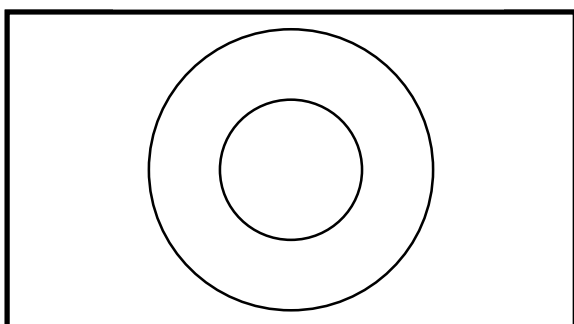

Fig.3-4 Cinema mode

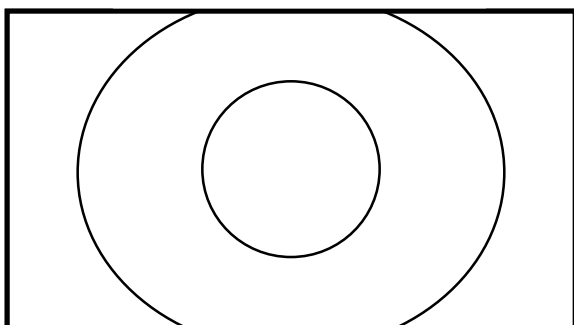

Fig.3-5 Wide 2 mode

5-2)Functions, Modes and Terminals (Table 4)

Mode terminals					Sync,signal I/O terminals					
CLKC	NTP	MODS	MODW	MODN	HSY	VSY	CLK	VCS	SYN	Remarks
H	H or L	L	H	L	H sync. output	V sync. output	Lo output	test signal output	Composite sync. input	test mode
H	H or L	H	L	H	H sync. output	V sync. output	Lo output	Masking signal output	Composite sync. input	NTSC or PAL mode (Normal mode)
H	H or L	other H or L settings			H sync. output	V sync. output	Lo output	Lo output	Composite sync. input	NTSC or PAL mode (Full, Wide, Cinema)
L	H	H	H	H	H sync. input	V sync. input	Pixel clock input	Lo output	input Hi or Lo fixed value	External clock synchronous mode

5-3) Backlight fluorescent tube driving part

Table 5-1 Lamp

terminal	No.	symbol	i / O	function	remarks
CN2	1	V L 1 A	i	input terminal (hi voltage side)	
	2	NC	—	non connection	
	3	V L 2 A	i	input terminal(low voltage side)	

Table 5-2 Thermistor

terminal	No.	symbol	remarks
CN3	1	TH1	Thermistor
	2	TH2	Thermistor

Caution:

Please use this thermistor in order to check the lamp temperature
 Model number of Thermistor : 203GT-1 made by Ishizuka Electronics
 Zero load resistance value at 25 °C : 20.0kΩ ±3%

(6) Absolute maximum ratings

Table 6

GND = 0 V

Parameter	Symbol	MIN	MAX	Unit	Note	
Positive power supply voltage	VSH	-0.3	+6.0	V	T _a = 25 °C	
Power supply for gate driver	Hi	VGH	-0.3	+33.0	V	"
	Lo	VGL	VGH-33.0	VGH+0.3	V	"
Input signals [terminal 4-1]	VIA	-0.3	VSH+0.3	V	"	
Input signals [terminal 4-2]	VID	-0.3	VSH+0.3	V	"	
Output signals [terminal 4-3]	VOD	-0.3	VSH+0.3	V	"	
DC bias voltage of common electrode driving signal	VCCDC	-4	+6	V	"	
Storage temperature	Tstg	-30	85	°C	【Note 4-1,2】	
Operating temperature (panel surface)	Topr1	-30	85	°C	【Note 4-2,3,4】	
Operating temperature (Ambient temperature)	Topr2	-30	65	°C	【Note 4-4,5】	

[terminal 4-1]VR, VG, VB

[terminal 4-2]HSY, SYN, NTP, VSY, HRV, VRV, CLKC, VMSW, MODS, CLK, MODW, MODN

[terminal 4-3]HSY, FRPT, FRPV, VCS, VSY, CLK, PWM

【Note 4-1】 This rating is applied to all parts of the module and should not be exceeded.

【Note 4-2】 Maximum wet-bulb temperature is less than 58°C. Condensation of dew must be avoided as electrical current leaks will occur, causing a degradation of performance specifications.

【Note 4-3】 Please measure in the effective display area only.

【Note 4-4】 The operating temperature only guarantees operation of the circuit. For contrast, speed response, and other factors related to display quality, determine operating temperature using the formula T_a = +25°C

【Note 4-5】 Ambient temperature when the backlight is lit (reference value).

(7) Electrical characteristics
 7-1) Recommended operating conditions
 A) TFT-LCD panel driving section

Table 7

GND = 0 V, T a = 25 °C

Parameter	Symbol	MIN	TYP	MAX	Unit	Remarks		
Positive power supply voltage	VSH	+4.75	+5.0	+5.5	V	【Note 5-1】		
Power supply for gate driver	Hi voltage	VGH	+12.5	+13.0	+13.5		V	
	Lo voltage	VGL	-15.5	-16.0	-16.5		V	
Input voltage [terminal 5-1]	AC component	VIAC	+2.0	-	±2.0	V	【Note 5-2】	
	DC component	VIDC	VSM-0.1	VSM	VSM+0.1	V	【Note 5-3】	
Input voltage [terminal 5-2]	VID	0	-	VSH	V			
Input horizontal sync. signal [terminal 5-3]	frequency	NTSC	fH(N)	15.13	15.73	16.33	CLKC='Hi'	
		PAL	fH(P)	15.03	15.63	16.23		kHz
	pulse width	NTSC	τ HI(N)	4.2	4.7	5.2		μs
		PAL	τ HI(P)	4.2	4.7	5.2		μs
	rising time	τ rHI1	-	-	0.5	μs		
	falling time	τ fHI1	-	-	0.5	μs		
Input vertical sync. signal [terminal 5-4]	frequency	NTSC	fV(N)	fH/284	fH/262.5	fH/258	CLKC='Hi'	
		PAL	fV(P)	fH/344	fH/312.5	fH/304		Hz
	pulse width	NTSC	τ VI(N)	-	3H	-		μs
		PAL	τ VI(P)	-	2.5H	-		μs
Input vertical sync. signal [terminal 5-4,7]	rising time	τ rVI	-	-	0.5	μs	CLKC='Hi' or 'Lo'	
	falling time	τ fVI	-	-	0.5			
Input clock [terminal 5-5]	frequency	fCLI	7.2	8.0	8.8	MHz	CLKC='Lo'	
	Hi pulse width	τ WH	20.0	-	-			ns
	Lo pulse width	τ WL	20.0	-	-			ns
	rising time	τ rCLI	-	-	10.0			ns
	falling time	τ fCLI	-	-	10.0			ns
Input horizontal sync. signal [terminal 5-6]	frequency	fHI	fCLI/550	fCLI/508	fCLI/490	kHz	CLKC='Lo'	
	pulse width	τ HI	1	5	9			μs
	rising time	τ rHI2	-	-	0.05			μs
	falling time	τ fHI2	-	-	0.05			μs
Input vertical sync. signal [terminal 5-7]	frequency	fVI	50	fHI/262	fHI/258	Hz	CLKC='Lo'	
	pulse width	τ VI	1H	3H	5H			μs
Data setup time [terminal 5-5,6]	tSU1	25	-	-	ns	CLKC='Lo'		
Data hold time [terminal 5-5,6]	tHO1	25	-	-	ns	【Note 5-4】		
Data setup time [terminal 5-5,7]	tSU2	1.0	-	-	μs	CLKC='Lo'		
Data hold time [terminal 5-5,7]	tHO2	1.0	-	-	μs	【Note 5-5】		
Polarity alternating delay time (FRPV-VRGB)	τ DV	-	-	4	μs			
Polarity alternating delay time (FRPT-COM)	τ DC	-	-	4	μs			
Common electrode driving signal	AC component	VCAC	±0.5	±3.9	±5.0	V	【Note 5-2】	
	DC component	VCDC	+0.0	+1.6	+3.0	V	【Note 5-6】	

Caution:

Power switch on (or off) must be done with all power supplies. And, the signals must input after power has been turned on.

- [terminal 5-1] V R, V G, V B
- [terminal 5-2] H S Y, S Y N, N T P, V S Y, H R V, V R V, C L K C, V M S W, M O D S, C L K, M O D W, M O D N
- [terminal 5-3] S Y N (horizontal sync. component)
- [terminal 5-4] S Y N (vertical sync. component)
- [terminal 5-5] C L K
- [terminal 5-6] H S Y
- [terminal 5-7] V S Y

- 【Note 5-1】 Any change in voltage after adjusting VCDC should be less than 0.1 V.
- 【Note 5-2】 Positive and negative amplitudes should be equal. When the AC input voltage is $-/+$, FRPV and T are in phase. When the AC input voltage is $+/-$, FRPV and T are 180° out of phase. The MIN value produces a white display, and the MAX value produces a black display.
- 【Note 5-3】 $VSM=VSH/2$. Any change in voltage after adjusting VCDC should be less than 0.1 V.
- 【Note 5-4】 During the clock input mode, CLK and the HSY input signal are out of phase. In this mode, the HSY input signal is effected by the rise time of the CLK input signal.
- 【Note 5-5】 During the clock input mode, HSY and the VSY input signal are out of phase. In this mode, the VSY input signal is effected by the rise time of the HSY input signal.
- 【Note 5-6】 To obtain the maximum value of contrast, each module must be adjusted to an optimum voltage.

B)Backlight driving section

Table 8

Parameter	Symbol	MIN	TYP	MAX	Unit	Remarks
lamp voltage	V L 7	630	700	770	Vrms	I L = 6.5mArms
lamp current	I L	6.0	6.5	7.0	MArms	at Normal Operation
	I L B	-	-	9.0	MArms	at PWM Dimming 【Note 6-3】
lamp frequency	f L	35	-	60	kHz	
kick-off voltage	V S	-	-	3000	Vrms	Ta=+25°C 【Note6-2】
		-	-	3000	Vrms	Ta=-30°C 【Note6-2】

Inverter : HIU-288 [C=12pF] Harison Electric co. Ltd.

- 【Note 6-1】 The sin wave which is symmetrical wave of both positive and negative without spike wave shall be used for inverter.
- 【Note 6-2】 The metal shield case of the module shall be connected to GND of the inverter circuit.
- 【Note 6-3】 Usable area for Backlight lighting

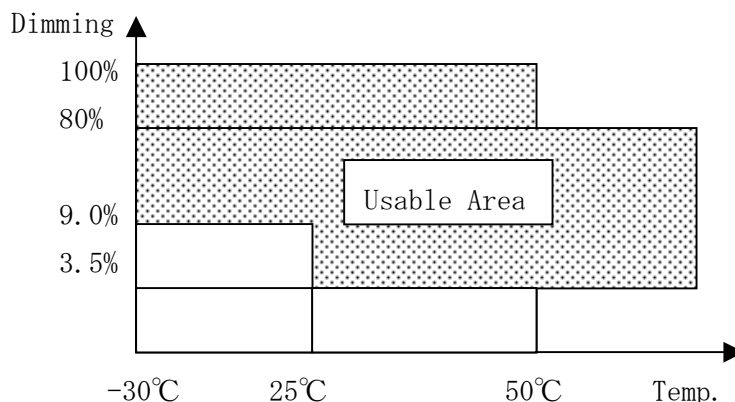

7-2) Electrical characteristics

Table 9

VSH=+5.3V, GND=0V, Ta=-30~85°C

Parameter		Symbol	MIN	TYP	MAX	Unit	Remarks
input voltage [terminal 7-1]	Hi	VIT+	-	-	+3.7	V	
	Lo	VIT-	+1.0	-	-	V	
	Hysteresis	V+ - V-	+0.2	-	-	V	
input voltage [terminal 7-2]	Hi	VIDH	+3.5	-	-	V	
	Lo	VIDL	-	-	+1.5	V	
output voltage [terminal 7-3]	Hi	VOH1	+4.0	-	-	V	IODH1=-80 μA
	Lo	VOL1	-	-	+0.4	V	IODL1=80 μA
output voltage [terminal7-4]	Hi	VOH2	+4.0	-	-	V	IODH2=-0.8mA
	Lo	VOL2	-	-	+0.4	V	IODL2=1.6mA
input current [terminal 7-5]	Hi	IIH1	-	-	+1	μA	VID=VSH
	Lo	IIL1	-	-	+1	μA	VID=0V
input current [terminal 7-6]	Hi	IIH2	-	-	+2	μA	VID=VSH
	Lo	IIL2	+5.0	-	+75	μA	VID=0V
input capacity (reference) [terminal7-7]		CIA	-	160	-	pF	f=1MHz
input capacity (reference) [terminal 7-1,2]		CID	-	20	-	pF	f=1MHz

[terminal 7-1]SYN terminal

[terminal 7-2]HSY, VSY, CLK, NTP, HRV, VRV, CLKC,VMSW, MODS, MODW,
MODN terminal

[terminal 7-3]HSY,FRPT,FRPV,VCS,VSY,PWM,TST terminal

[terminal 7-4]CLK terminal

[terminal 7-5]SYN terminal

[terminal 7-6]HSY,NTP,VSY,HRV,VRV,CLKC, V M S W, MODS,CLK,MODW,
MODN terminal

[terminal 7-7]VR,VG,VB terminal

7-3)Power consumption

Table 10

Ta=25°C

Parameter		Sym	Conditions	MIN	TYP	MAX	Unit	Remarks
LCD panel Driving power Consumption	Source	ISH	VSH=+5.0V	-	60	75	mA	
	gate high	IGH	VGH=+13.0V	-	1.3	2.0	mA	
	gate low	IGL	VGL=-16.0V	-	3.0	5.5	mA	
	Total	WS		-	365	489	mW	【Note 7-8】
Lamp power consumption		WL	Normal driving	-	4.55	-	W	Reference data of calculation

【Note 7-8】 excluding backlight section

7-4)Input/output signal waveforms

Refer to Fig.4-A,B,C,D,E,F,G,H

Caution:

In case of NTSC or PAL mode, please input standard composite video (or sync.) signal, NTSC(M) or PAL(B,G).

If the non-standard sync. signal would be input for a long time, it may cause flicker or decline in the display quality.

In the case of external clock mode, the signal shall be input under the condition shown in Table. 7.

7-5)Input/Output signal timing chart

Table 11

VSH=+5.3V,GND=0V

CLKC=Hi

NTSC:fH=15.73kHz,fv=60Hz, $\tau_{HI}=4.7 \mu s$

PAL:fH=15.63kHz,fv=50Hz, $\tau_{HI}=4.7 \mu s$

Parameter	Symbol	MIN	TYP	MAX	Unit	Remarks	
Horizontal sync. output [HSY]	frequency	fHO	-	fH	-	kHz	
	pulse width	τ_{HO}	2.0	4.6	8.0	μs	【Note 9-1】
	rising time	τ_{rHO}	-	-	0.5	μs	CL=10pF
	falling time	τ_{fHO}	-	-	0.5	μs	CL=10pF
Horizontal sync. phase difference [HSY-SYN]	HSY falling time	τ_{pd1}	0.5	1.1	3.0	μs	【Note 9-2】
	HSY rising time	τ_{pd2}	-	1.1	3.4	μs	
Vertical sync. output [VSY]	frequency	fVO	-	fV	-	Hz	
	pulse width	τ_{VO}	-	4H	-	μs	1H=1/fH
	sync. output difference	τ_{VHO}	-	11	29	μs	
	rising time	τ_{rVO}	-	-	2.0	μs	CL=10pF
	falling time	τ_{fVO}	-	-	2.0	μs	CL=10pF
Vertical sync. phase difference [SYN-VSY]	odd field	τ_{DV1}	-	1H	-	μs	
	even field	τ_{DV2}	-	0.5H	-		
Polarity alternating output signal [FRPT,FRPV]	rising time	τ_{rFR}	-	-	0.5	μs	CL=10pF
	falling time	τ_{fFR}	-	-	0.5	μs	CL=10pF

【Note7-1】 This is changed by the value of τ_{pd1}

【Note7-2】 Center position : $\tau_{pd1}= 1.1 \pm 0.5 \mu s$ (NTSC mode)

7-6) Display time range

- (1) NTSC(M) mode (NTP='Hi',CLKC='Hi')
- (a1) Horizontal Direction (full,wide1,2,cinema)
13.1 ~ 63.2 μ s from the falling edge of HSY.
 - (a2) Horizontal Direction (normal)
7.9 ~ 68.4 μ s from the falling edge of HSY
 - (b1) Vertical Direction (full,wide1,normal)
 - 1) VMSW="Hi" : 19 ~ 258 H from the falling edge of VSY
 - 2) VMSW="Lo" : 20 ~ 253 H from the falling edge of VSY
 - (b2) Vertical Direction (Cinema)
 - 1) VMSW="Hi" : 48 ~ 228 H from the falling edge of VSY
 - 2) VMSW="Lo" : 49 ~ 224 H from the falling edge of VSY
 - (b3) Vertical Direction (Wide2)
 - 1) VMSW="Hi" : 41 ~ 232 H from the falling edge of VSY
 - 2) VMSW="Lo" : 42 ~ 228 H from the falling edge of VSY
- (2) PAL(B·G) mode (NTP='Lo',CLKC='Hi')
- (a1) Horizontal Direction (full,wide1,2,cinema)
13.1 ~ 63.2 μ s from the falling edge of HSY
 - (a2) Horizontal Direction (normal)
7.9 ~ 68.4 μ s from the falling edge of HSY. (Normal)
 - (b1) Vertical Direction (full,wide1,normal)
 - 1) VMSW="Hi" : 25 ~ 304 H from the falling edge of VSY
 - 2) VMSW="Lo" : 26 ~ 298 H from the falling edge of VSY

However, the video signals of (14n+12)H,(14n+20)H/Even field.
(14n+17)H,(14n+23)H/Odd field (n=1,2···, 20)
are not displayed on the module.
 - (b2) Vertical Direction (cinema)
 - 1) VMSW="Hi" : 48 ~ 287 H from the falling edge of VSY
 - 2) VMSW="Lo" : 49 ~ 282 H from the falling edge of VSY
 - (b3) Vertical Direction (wide2)
 - 1) VMSW="Hi" : 34 ~ 297 H from the falling edge of VSY
 - 2) VMSW="Lo" : 35 ~ 291 H from the falling edge of VSY

However, the video signals of (22n+14)H,(22n+21)H/Even field.
(22n+25)H,(22n+32)H/Odd field (n=1,2···, 12)
are not displayed on the module.
- (3) External clock mode (NTP='Hi',CLKC='Lo')
- Displaying the following range within video signals.
- (a) Horizontal Direction : 86 ~ 485 clk from the falling edge of HSY.
(clk means input external clock.)
 - (b) Vertical Direction : 19 ~ 258H from the falling edge of VSY.

(8)Optical characteristics

Table 12

Ta=25°C

	Parameter	Symbol	Condition	Min	Typ	Max	Unit	Remarks
T R A	Viewing angle	$\Delta \theta 11$	$CR \geq 5$	40	50	-	° (degree)	【Note10-1,2,3,4】
		$\Delta \theta 12$		30	40	-	° (degree)	
		$\Delta \theta 2$		40	50	-	° (degree)	
N	Contrast ratio	CRmax	Optimal	60	-	-		【Note10-1,3,4】
S M	Response time	Rise	$\theta = 0^\circ$	-	15	30	ms	【Note10-1,3,5】
		Fall		τd	-	35	70	
I S	Luminance	Y	IL=6.5mArms	160	220	-	cd/m ²	【Note10-1,6】
		-20°C	YLOW	IL=9mArms		60		【Note10-1,6,7】
S I	White chromaticity	x	IL=6.5mArms	0.263	0.313	0.363		【Note10-1,6】
		y	IL=6.5mArms	0.279	0.329	0.379		
V E	lamp life time	+25°C	continuation	10,000	-	-	hour	【Note10-1,8】
		-30°C	intermission	2,000	-	-	time	【Note10-1,9】
R E F	Reflectivity	Rf	30° in/10° Meas.	-	10	-	%	【Note10-10,11】
			Integrating sphere		(3.8)		%	Reference 【Note10-11,12】
R E C	Viewing angle	$\Delta \theta 11/12$	$CR \geq 2$	40	45	-	° (degree)	【Note10-4,12, 13,15】
		$\Delta \theta 2$		45	50	-	° (degree)	
T	Contrast ratio	CR	$\theta = 0^\circ$	5	7	-		【Note10-12,13,14】
I V	Response time	Rise	$\theta = 0^\circ$	-	15	30	ms	【Note10-5,12, 13】
		Fall		τd	-	35	70	
E	White chromaticity	x	$\theta = 0^\circ$	0.269	0.319	0.369		【Note10-12,15】
		y	$\theta = 0^\circ$	0.299	0.349	0.399		

【Note10-1】

Refer the measurement method as shown in Fig.4

Just for evaluation, the following inverter can be used.

Harison Co.: HIU-359A-W2

To be measured after 30minutes of lamp lighting

Please make sure enough with an actual model for unevenness arises in luminance, at the reason of installation states of the module, the leading line of taking around for the lamp and matching with the inverter.

【Note 10-2】 Viewing angle range is defined as follows.

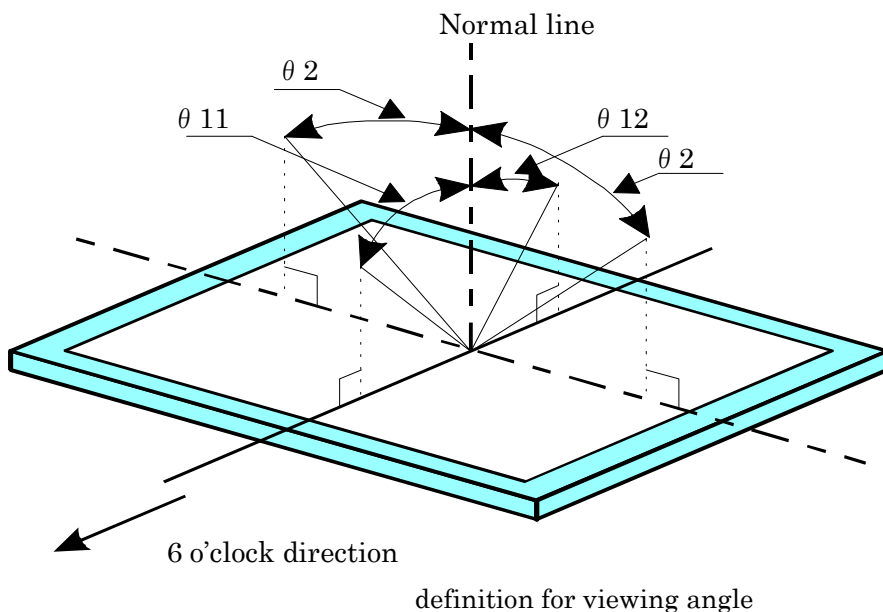

【Note 10-3】 Applied voltage condition for the measurement of transmissive mode:
 1) VDC is adjusted so as to attain maximum contrast ratio.
 2) Input $\pm 1.90V$ at VIAC.
 When V_{i50} transmission is 50% at Voltage-Transmission curve,
 Black level : $V_{i50} = \pm 2.5V$, White level : $V_{i50} = +1.5V$

【Note 10-4】 Contrast ratio is defined as follows:

$$\text{Contrast ratio(CR)} = \frac{\text{Photodetector output with LCD being "white"}}{\text{Photodetector output with LCD being "black"}}$$

【Note 10-5】 Response time is obtained by measuring the transition time of photodetector output, when input signals are applied so as to make the area "black" to and from "white".

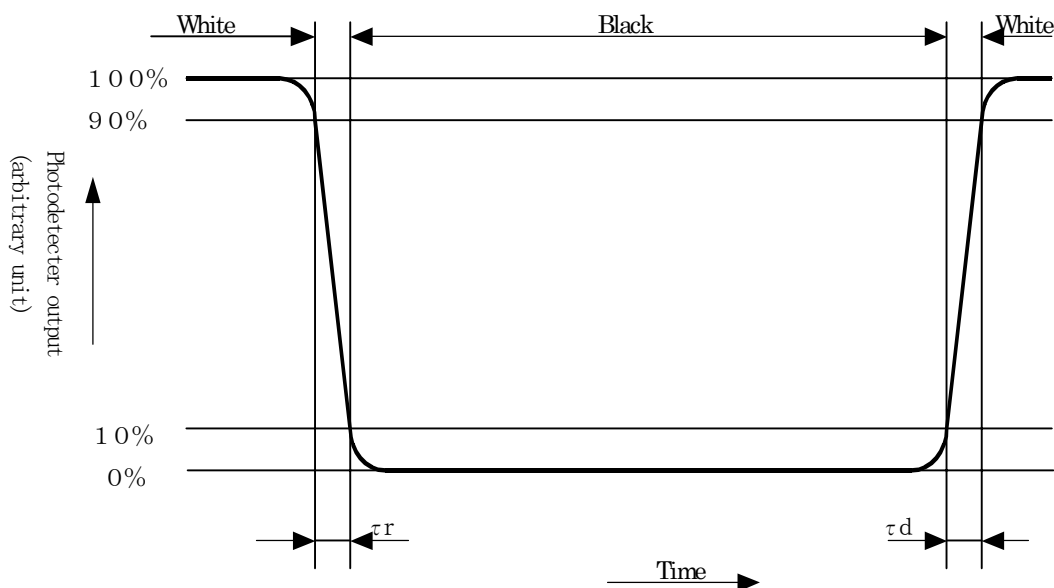

- 【Note 10-6】 Measured on the center area of the panel at a viewing cone 1° by TOPCON luminance meter BM-7.(After 30 minutes operation)
DC/AC inverter driving frequency:(49kHz)
- 【Note 10-7】 Ambient temperature : -20°C
Measured luminance on the panel after 2 minutes operation.
- 【Note 10-8】 Lamp life time is defined as the time when either or occurs in the continuous operation under the condition of lamp current IL=3.0~7.0mArms and (Lighting Condition)
Electric Current dimming : Continuous lighting at IL=6.0~7.0mArms
PWM Dimming : Continuous lighting at IL=9mArms, Duty=80%~5%
- 【Note 10-9】 The intermittent cycles is defined as a time when brightness not to become under 50% of the original value under the condition of following cycle.

Ambient temperature:-30°C

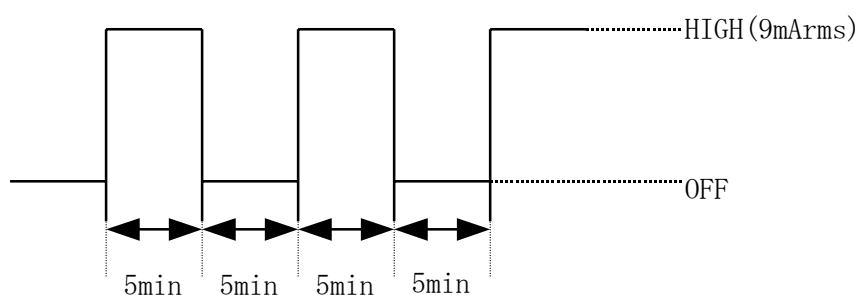

- 【Note 10-10】 The optical measurement A for reflective mode is defined in Fig.6(a).
- 【Note 10-11】 Reflectivity is defined as follow;
The intermittent cycles is defined as a time when brightness not to become under 50% of the original value under the condition of following cycle.

$$\text{Reflectivity (Rf)} = \frac{\text{Reflective intensity at non-operating}}{\text{Reflective intensity with LCD being "White"}}$$

- 【Note 10-12】 The optical measurement B for reflective mode is defined in Fig.6(b).
- 【Note 10-13】 Applied voltage condition for the measurement of reflective mode
 - 1) VCDC is adjusted so as to attain maximum contrast ratio.
 - 2) Input ±1.90V at VIAC.
 When VI50= transmission is 50% at Voltage-Transmission curve,
 Black level : Vi50=±2.5V, White level :Vi50 =+1.5V

- 【Note 10-14】 Contrast ratio on reflective mode is defined as follows:

$$\text{Contrast ratio(CR)} = \frac{\text{Reflectivity in the center of screen with LCD being "white"}}{\text{Reflectivity in the center of screen with LCD being "black"}}$$

- 【Note 10-15】 Measured by Minoruta’s spectrophotometer CM-2002.
White chromaticity with LCD being “White” based on Lighting source (D65)
(Assumption of chromaticity of lighting source : X=0.313, Y=0.329)

(9) Mechanical characteristics

9-1) External appearance

Extreme defects should not exist. (See Fig. 1)

9-2) Panel toughness

The panel shall not be broken, when 19N is pressed on the center of the panel by a smooth sphere having 15 mm diameter.

Caution: In spite of very soft toughness, if, in the long-term, add pressure on the active area, it is possible to occur the functional damage.

9-3) Input/output connector performance

A) Input/output connectors for the operation of LCD module

(24 pin 【FRAMATOME CONNECTORS JAPAN LTD.】 :SFR24R-1STE1/5STE1)

1) Applicable FPC refer the below figure

2) Terminal holding force : More than 0.9N/pin : Thickness of FPC is $t=0.33\text{mm}$.

(Each terminal is pulled out at a rate of $25 \pm 3\text{mm/min.}$)

3) Insertion/pulling : contact resistance is not twice larger than the durability initial value after applicable FPC is inserted and pulled out 20 times

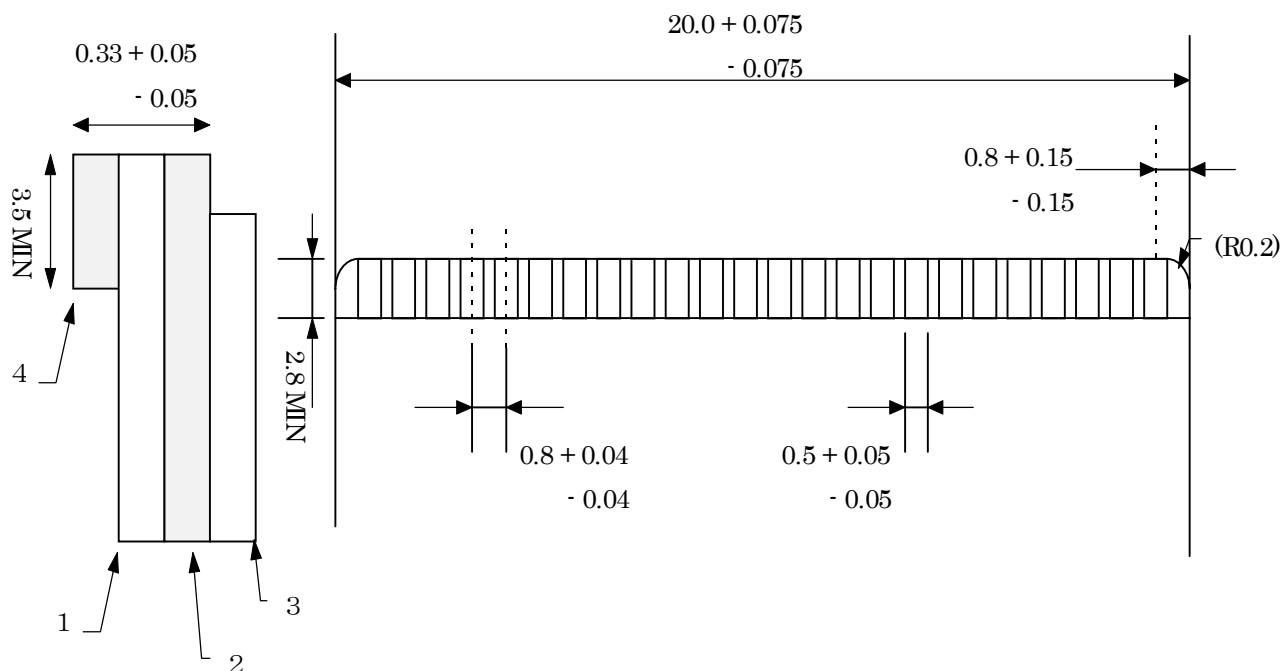

No.	Name	Materials
1	Base material	Polyimide or equivalent material(25 μ m thick)
2	Copper foil	Copper foil(35 μ m thick) Solder plated over 2 μ m
3	Cover lay	Polyimide or equivalent material
4	Reinforcing plate	Polyester polyimide or equivalent material(188 μ m thick)

FPC applied to input/output connector (0.8mm pitch)

B) I/O connector of backlight driving circuit

Lamp Connector (JST)

Symbol	Used Connector	Corresponding connector
CN2	BHR-02(8.0)VS-1N	SM02(8.0)B-BHS-TB(assembled on PWB)
		SM02(8.0)B-BHS-1N(assembled on PWB)
		BHMR-03V (inter connector)

Thermistor Connector (Molex)

Symbol	Used Connector	Corresponding connector
CN3	51021-0200	53047-0210 (assembled on PWB : Straight type)
		53048-0210 (assembled on PWB : Right angle type)
		51047-0200 (inter connector)
		53398-0210 (assembled on PWB surface : Straight type)
		53261-0210 (assembled on PWB surface : Right angle type)

(10) Display quality

The display quality of the color TFT-LCD module shall be in compliance with the Delivery Inspection Standard.

(11) Handling instructions

11-1) Mounting of module

The TFT-LCD module is designed to be mounted on equipment using the mounting tabs in the four corners of the module at the rear side.

On mounting the module, as the M2.6 tapping screw fastening torque is 0.3 through 0.5 N·m (7mm length) is recommended, be sure to fix the module on the same plane, taking care not to wrap or twist the module.

Don't reach the pressure of touch-switches of the set side to a module directly, because images may be disturbed.

Please power off the module when you connect the input/output connector.

Please connect the metallic shielding cases of the module and the ground pattern of the inverter circuit surely. If that connection is not perfect, there may be a possibility that the following problems happen.

- a). The noise from the backlight unit will increase.
- b). The output from inverter circuit will be unstable. Then, there may be a possibility that some problems happen.
- c). In some cases, a part of module will heat.

11-2) Precautions in mounting

Polarizer which is made of soft material and susceptible to flaw must be handled carefully. Protective film (Laminator) is applied on the surface to protect it against scratches and dirt. It is recommended to peel off the laminator immediately before the use, taking care of static electricity.

Precautions in peeling off the laminator

A) Working environment

When the laminator is peeled off, static electricity may cause dust to stick to the polarizer surface. To avoid this, the following working environment is desirable.

- a) Floor: Conductive treatment of 1M Ω or more on the tile
(conductive mat or conductive paint on the tile)
- b) Clean room free from dust and with an adhesive mat on the doorway
- c) Advisable humidity: 50%~70% Advisable temperature: 15°C~27°C
- d) Workers shall wear conductive shoes, conductive work clothes, conductive gloves and an earth band.

B) Working procedures

- a) Direct the wind of discharging blower somewhat downward to ensure that module is blown sufficiently. Keep the distance between module and discharging blower within 20 cm.
- b) Attach adhesive tape to the laminator part near discharging blower so as to protect polarizer against flaw.
- c) Peel off laminator, pulling adhesive tape slowly to your side taking 5 or more second.
- d) On peeling off the laminator, pass the module to the next work process to prevent the module to get dust.

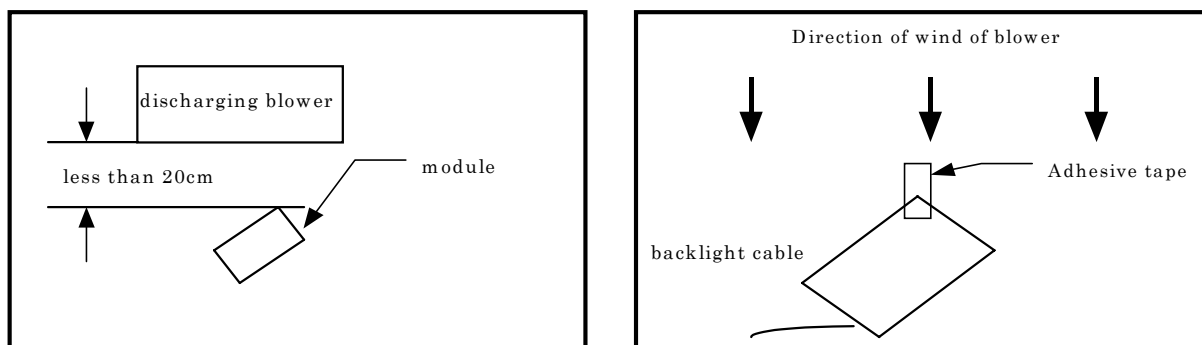

e) Method of removing dust from polarizer

- Blow off dust with N2 blower for which static electricity preventive measure has been taken. Ionized air gun (Hugle Electronics Co.) is recommended.
- Since polarizer is vulnerable, wiping should be avoided. But when the panel has stain or grease, we recommend to use adhesive tape to softly remove them from the panel.

When metal part of the TFT-LCD module (shielding lid and rear case) is soiled, wipe it with soft dry cloth. For stubborn dirt, wipe the part, breathing on it. Wipe off water drop or finger grease immediately. Long contact with water may cause discoloration or spots.

TFT-LCD module uses glass which breaks or cracks easily if dropped or bumped on hard surface. Handle with care.

Since CMOS LSI is used in this module, take care of static electricity and earth your body when handling.

11-3) Precautions in adjusting module

Adjusting volumes on the rear face of the module have been set optimally before shipment. Therefore, do not change any adjusted values. If adjusted values are changed, the specifications described here may not be satisfied.

11-4) Caution of product design

The LCD module shall be protected against water salt-water by the waterproof cover.

Please take measures to interferential radiation from module, to do not interfere surrounding appliances.

11-5) Others

Do not expose the module to direct sunlight or intensive ultraviolet rays for many hours; liquid crystal is deteriorated by ultraviolet rays.

Store the module at a temperature near the room temperature. At lower than the rated storage temperature, liquid crystal solidifies, causing the panel to be damaged. At higher than the rated storage temperature, liquid crystal turns into isotropic liquid and may not recover.

The voltage of beginning electric discharge may over the normal voltage because of leakage current from approach conductor by to draw lump read lead line around.

If LCD panel breaks, there may be a possibility that the liquid crystal escapes from the panel. Since the liquid crystal is injurious, do not put it into the eyes or mouth. When liquid crystal sticks to hands, feet or clothes, wash it out immediately with soap.

Observe all other precautionary requirements in handling general electronic components.

(12)Forwarding form

12-1)Fig.3 shows packing form.

12-2)Conditions for storage.

①Piling number of cartons : 10

②Environment

Temperature : 0~40°C

Humidity : 60%RH or less(at 40°C)

No dew condensation at low temperature and high humidity.

Atmosphere : Harmful gas, such as acid or alkali which bites electronic components and/or wires, must not be detected.

Period :About 3 months

Opening of the package : In order to prevent the LCD module from breakdown by electrostatic charges, please control the room humidity over 50%RH and open the package taking sufficient countermeasures against electrostatic charges, such as earth, etc.

(13)Reliability test conditions

Reliability test conditions for the TFT-LCD module are shown in Table 13.

(14)Others

14-1)Indication of lot number

The lot number is shown on a label. Attached location is shown in Fig.1(Outline Dimensions).

Indicated contents of the label

LQ065T9BR51	○○○○○○○○○○
model No.	lot No.

- Contents of lot No. the 1st figure ··· production year (ex.2000 : 0)
- the 2nd figure ··· production month 1,2,3,·····,9,X,Y,Z
- the 3rd~7th figure ··· serial No. 00001~
- the 8th figure ··· revision marks blank or A,B,C ···
- the 9th figure ··· production factory code blank or A,B,C ···

Reliability test conditions for TFT-LCD module

Table 13

Remark)

Temperature condition is based on operating temperature conditions on (6)-Table 6.

No.	Test items	Test conditions
1	High temperature storage test	Ta=+85°C 240H
2	Low temperature storage test	Ta=-30°C 240H
3	High temperature And high humidity operating test	Tp=+50°C, 90~95%RH 240H
4	High temperature operating test	Tp=+85°C 240H
5	Low temperature operating test	Tp=-30°C 240H
6	Electro static discharge test	±200V, 200pF(0Ω) 1 times for each terminals
7	Shock test	980m/s ² ·6ms, ±X, ±Y, ±Z 3times for each direction (JIS C0041,A-7 condition C)
8	Vibration test	<ul style="list-style-type: none"> ·Frequency range : 8~33.3Hz Stroke : 1.3mm Sweep : 33.3Hz~400Hz ·Frequency range : 8~33.3Hz Acceleration : 28.4 m/s² Cycle : 15 minutes X,Z 2 hours for each directions, 4 hours for Y direction (total 8 hours) 【caution】 (JIS D1601)
9	Heat shock test	Tp=-30~+85°C / 200cycles (0.5H) (0.5H)

【Note】 Ta=Ambient temperature, Tp=Panel temperature

【Check items】 In the standard condition, there shall be no practical problems that may affect the display function.

【Caution】 X,Y,Z directions are shown as follows

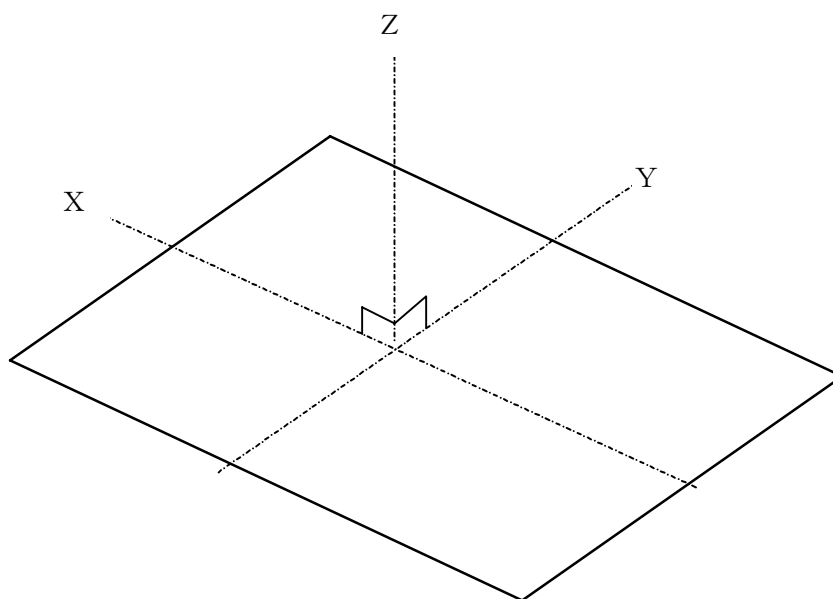

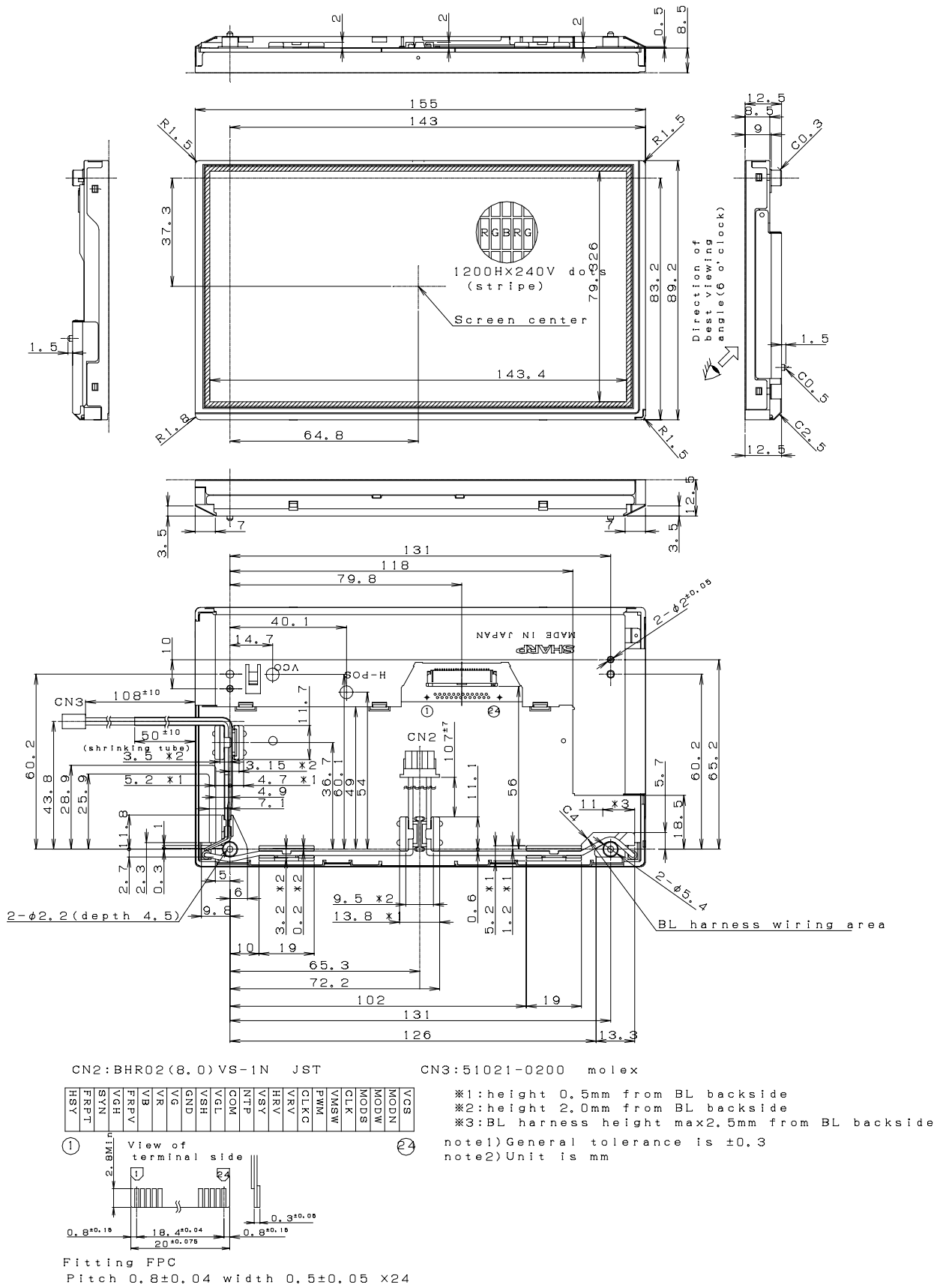

Fig1. Outline dimension of TFT-LCD module

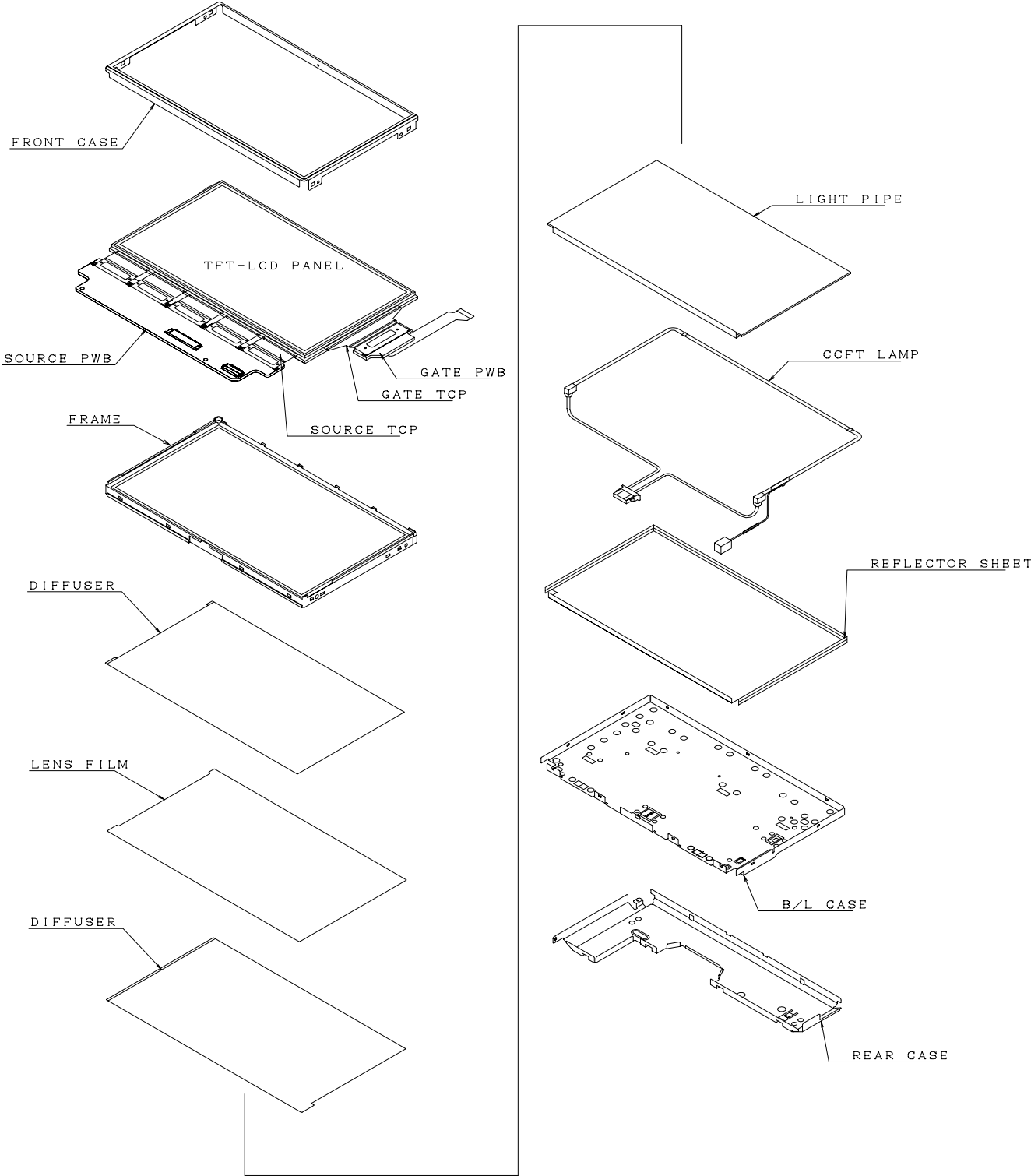

Fig2. Construction of TFT-LCD module

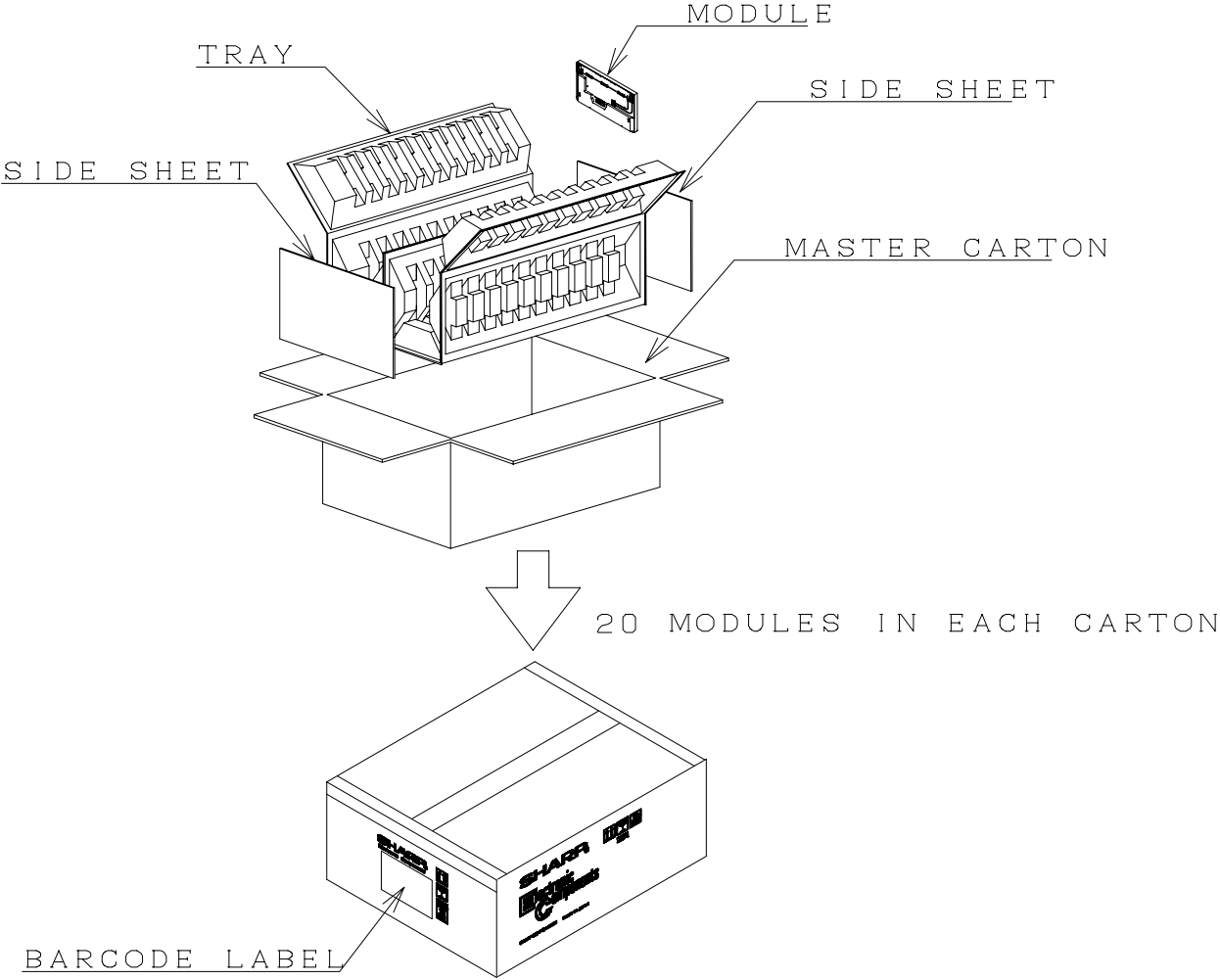

Fig3. Packing form

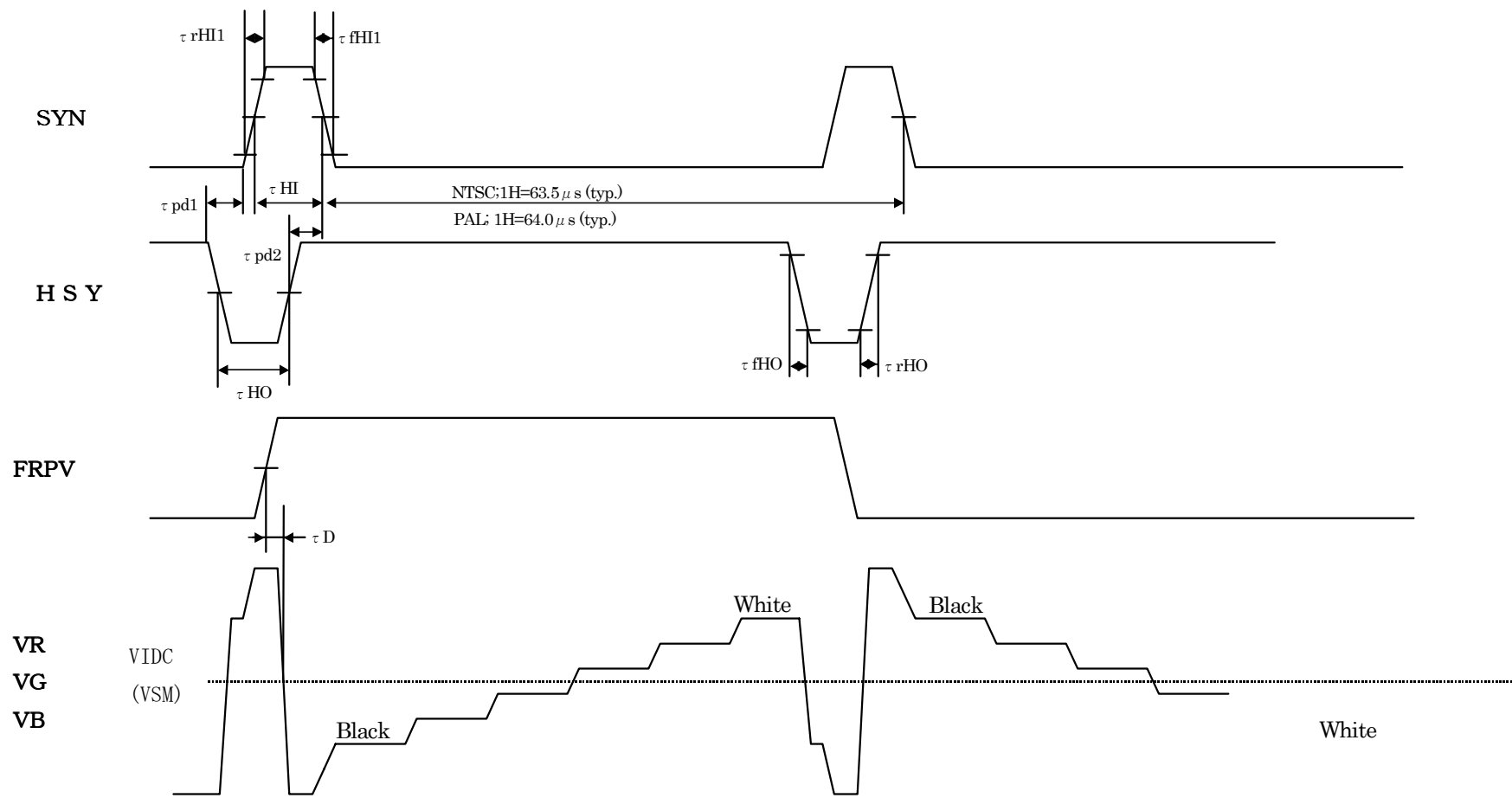

Fig. 4 - A Input-output signal waveform (NTSC, PAL system CLKC=Hi)

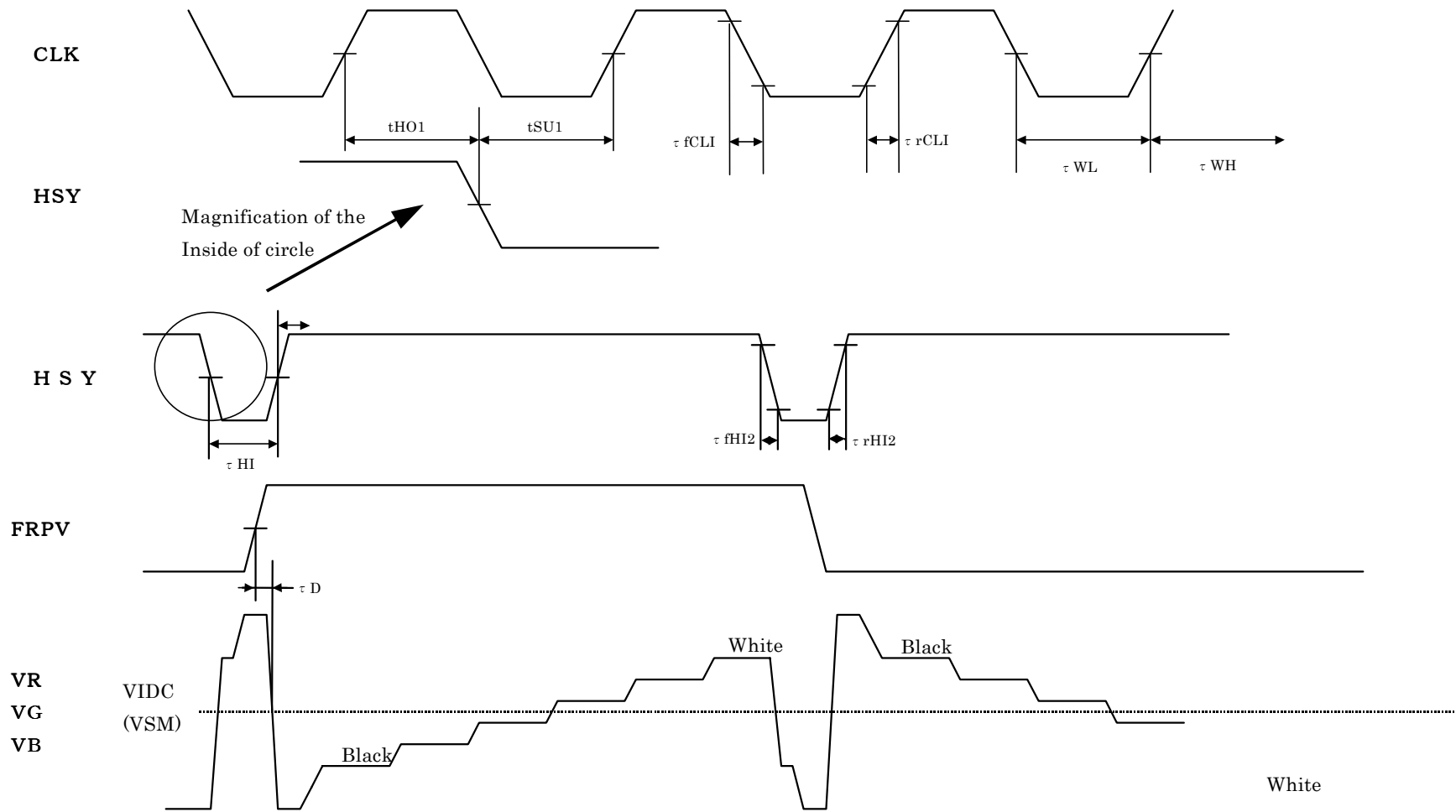

Fig4. - B Input-output signal waveform (External clock input synchronized system NTPC=Hi, CLKC=Lo, MODS=MODW=MODN=Hi)

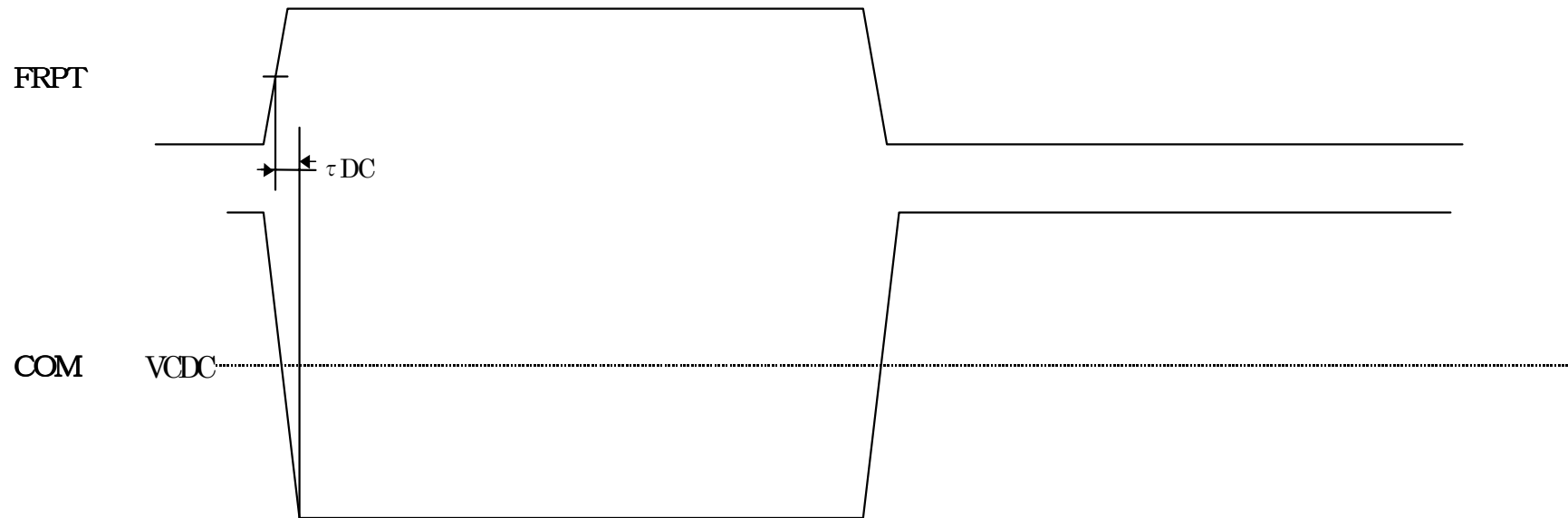

Fig. 4 - C Input-output signal waveform

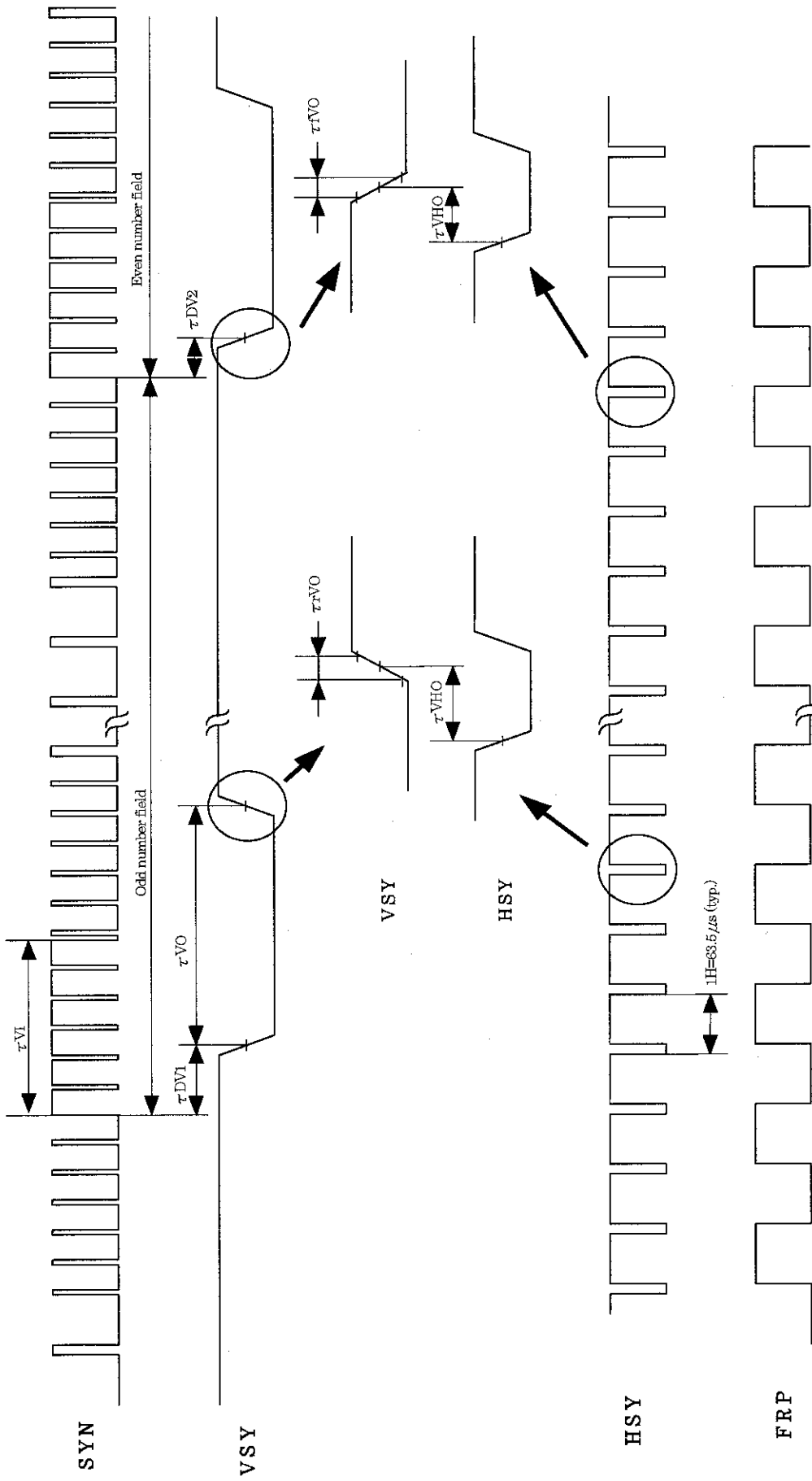

Fig4. -D Input-output signal waveform (NTSC system NTPC=Hi, CLKC=Hi)

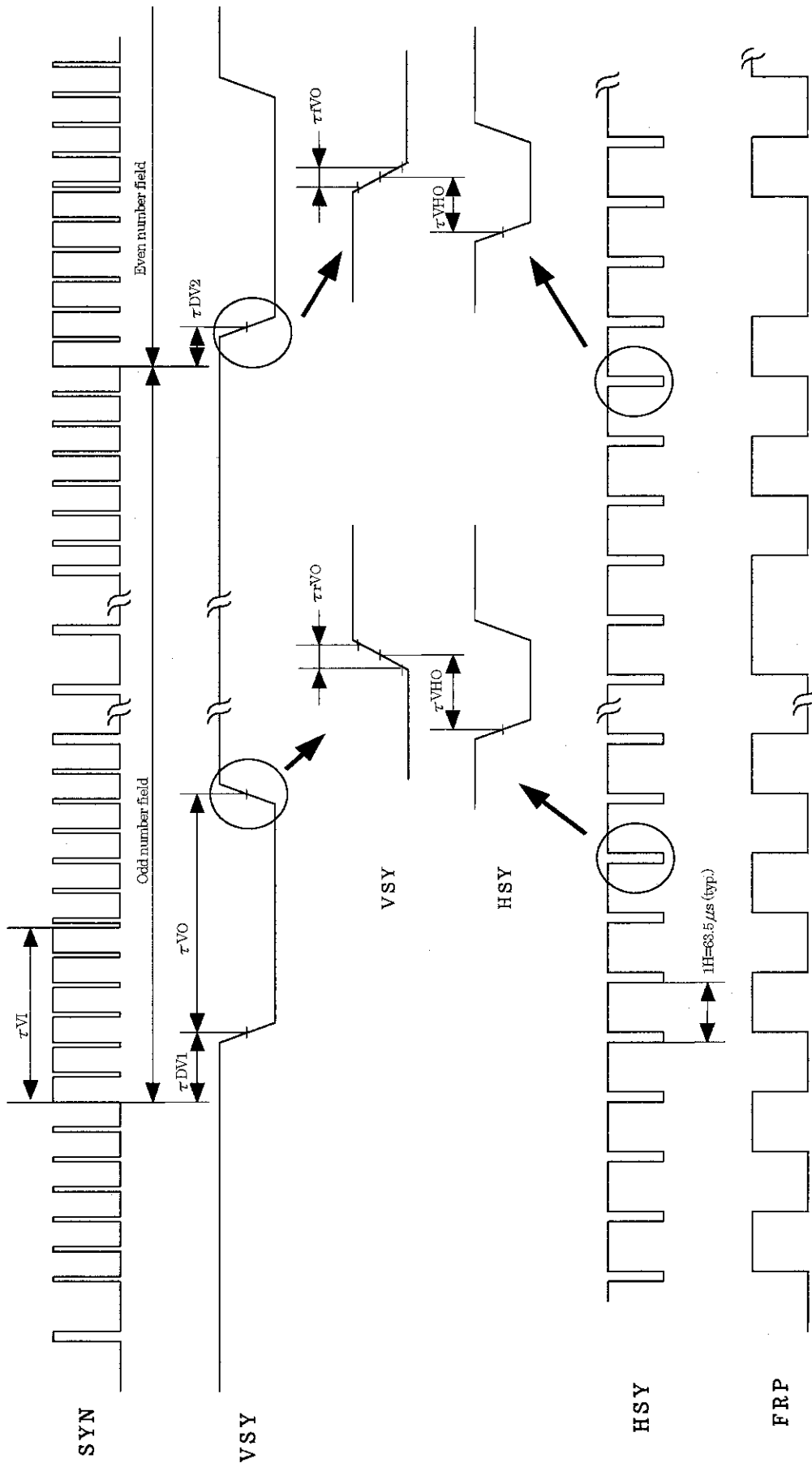

Fig4. -E Input-output signal waveform (PAL system NTPC=Lo, CLKC=Hi)

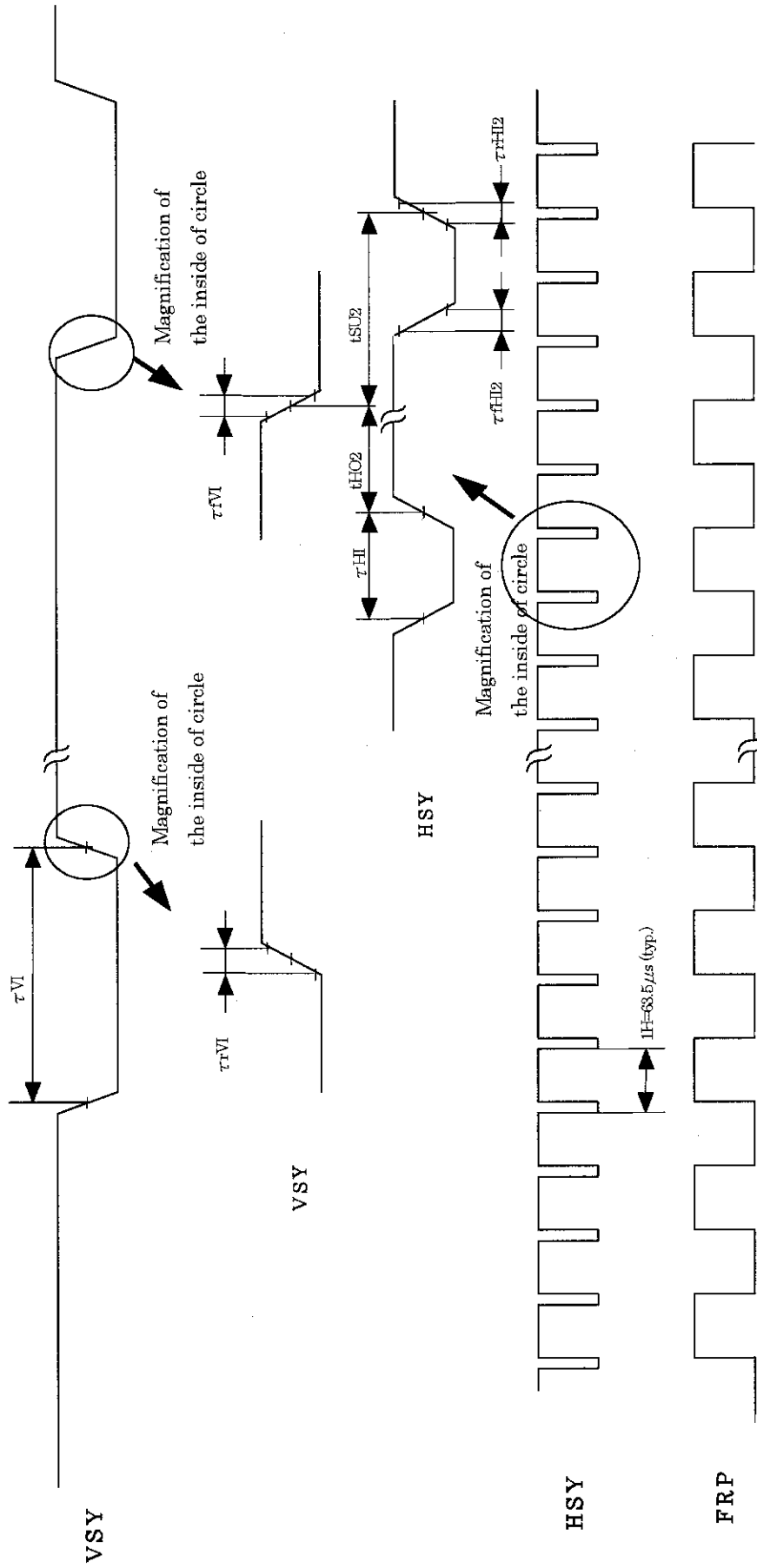

Fig4. - F Input-output signal waveform (External clock input synchronized system NTPC=Hi, CLKC=Lo)

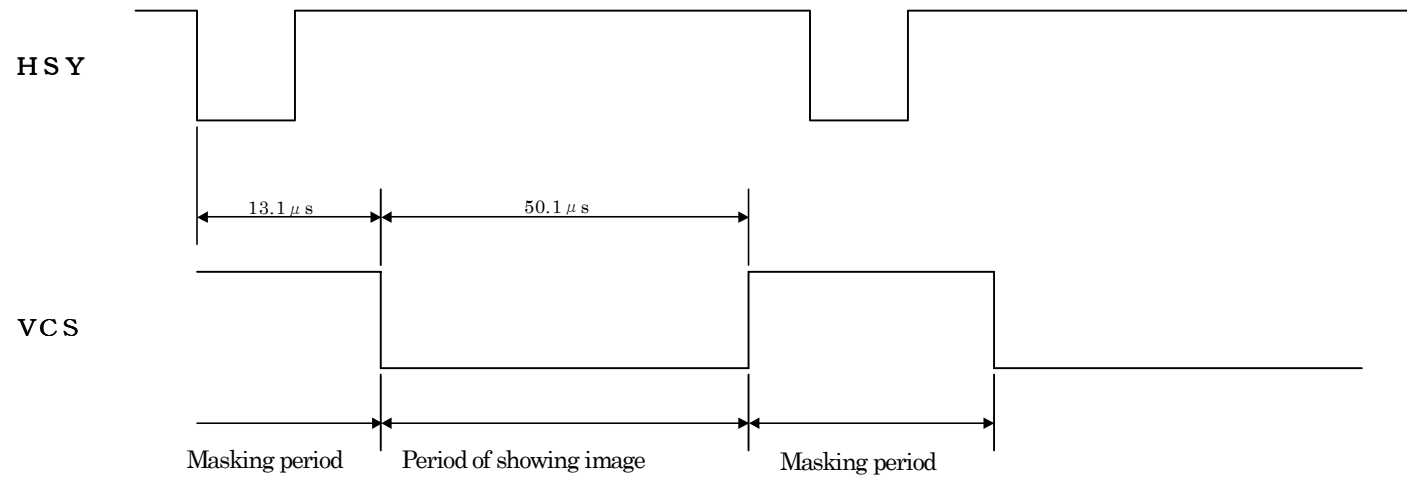

Fig. 4 – G Input-output signal waveform (Normal mode, NTSC, PAL system CLKC=Hi, MODS=Hi, MODW=Lo, MODN=Hi)

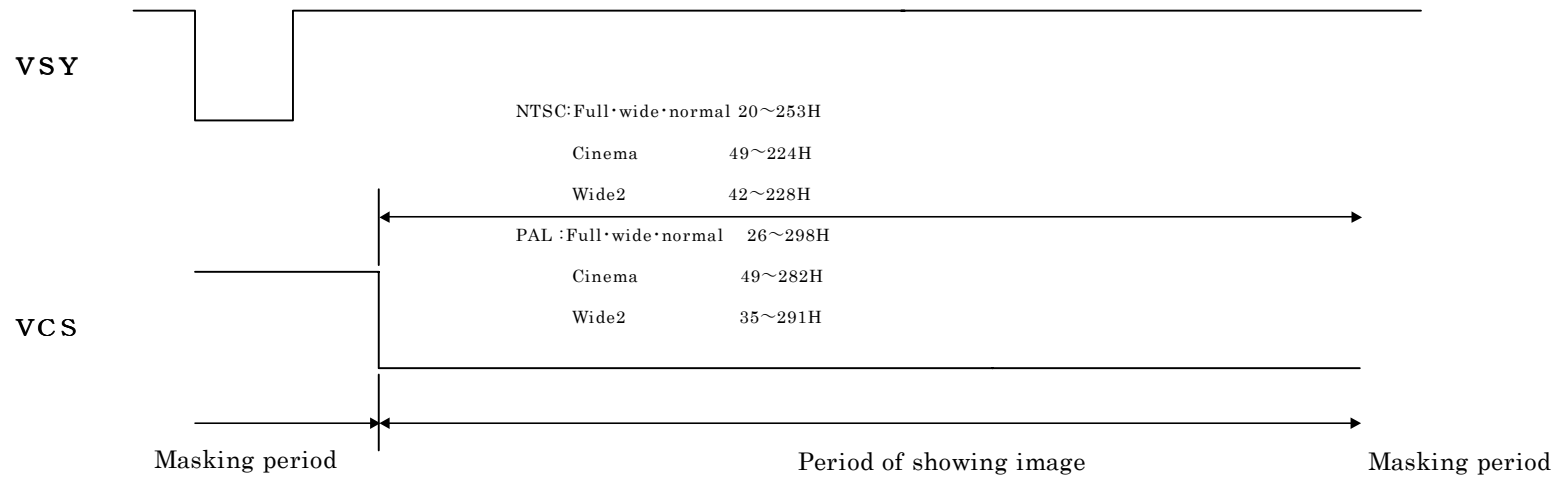

Fig4. -H Input-output signal waveform (Vertical mask mode、NTSC,PAL system VMSW=Lo)

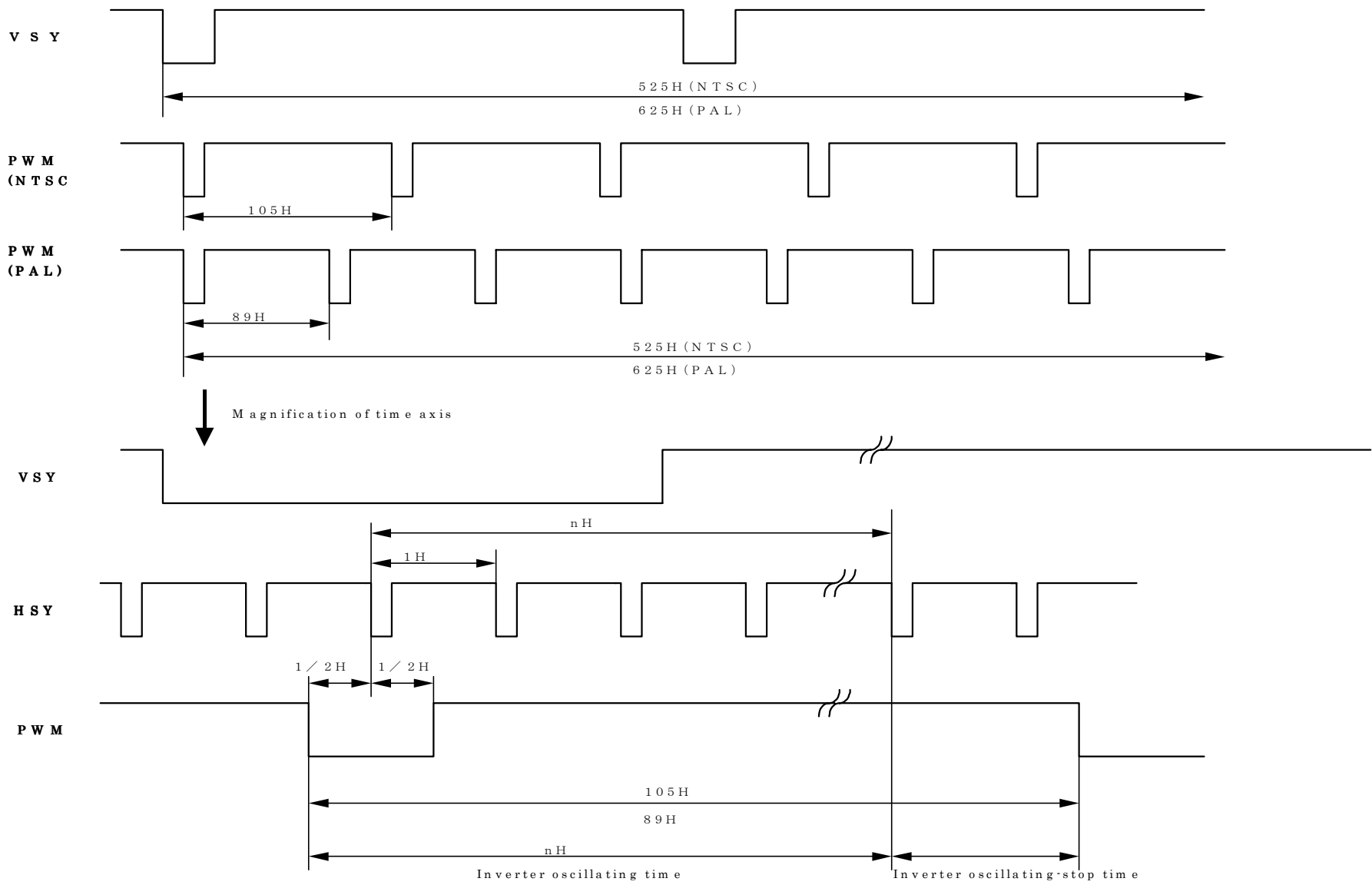

Fig. 4 - I PWM light-adjustment timing chart

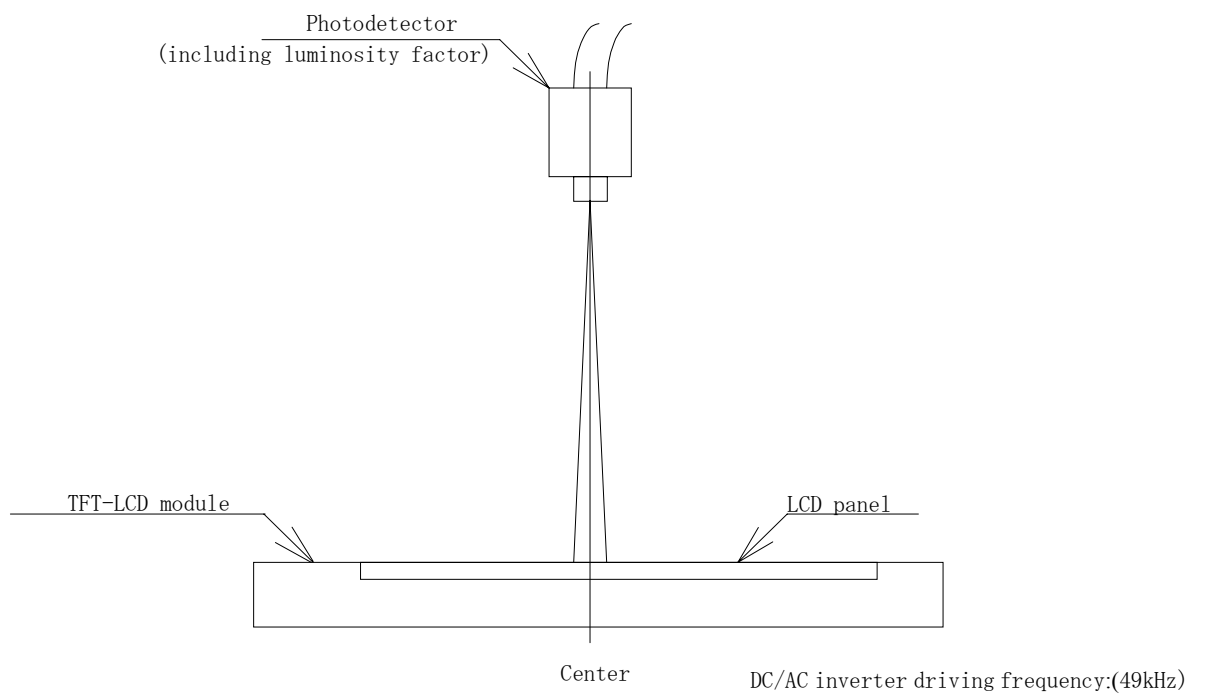

Fig. 5. Measurement method of optical characteristics(Transmissive mode)

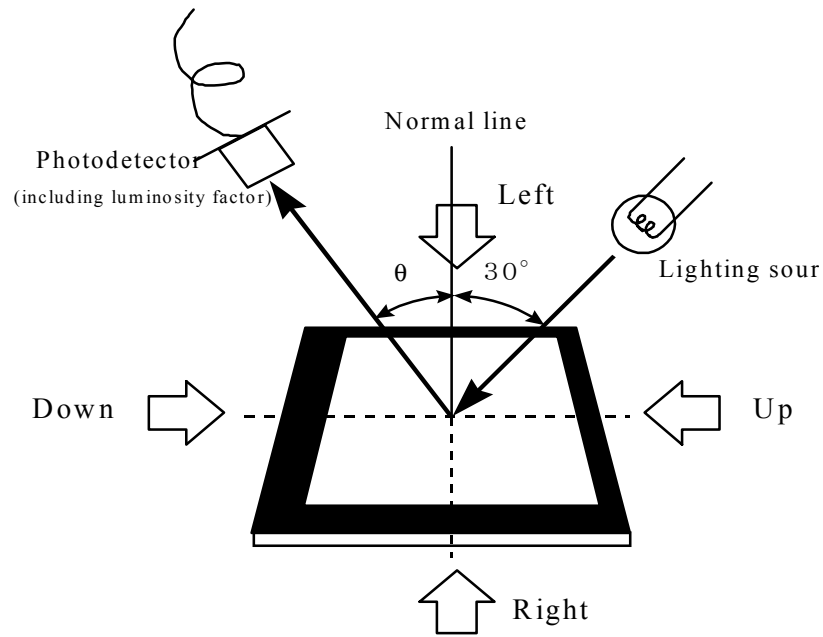

Fig. 6 (a). Measurement method of optical characteristic(Reflective mode) A

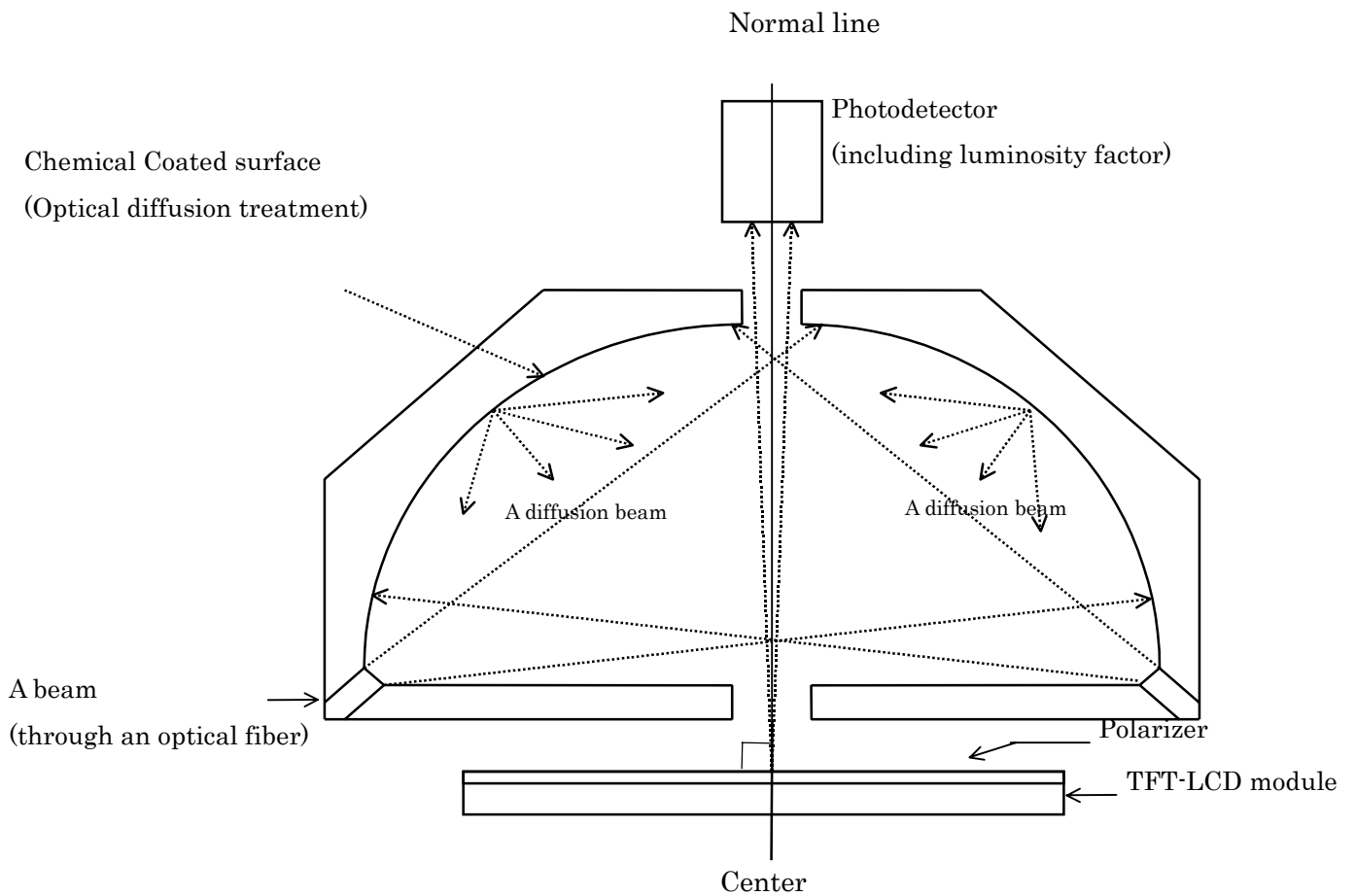

Fig6. (b). Measurement method of optical characteristic(Reflective mode) B

(Appendix-1)

Adjusting Method of Optimum Common electrode DC Bias Voltage

To obtain optimum DC bias Voltage of common electrode driving signal, photo-electric devices are very effective, and the accuracy is within 0.1V. (In visual examination method, the accuracy is about 0.5V because of the difference among individuals.)

To obtain optimum common electrode DC bias voltage, there is a measurement method as follows:

Measurement of flicker method

DC bias voltage is adjusted so as to minimize NTSC: 60Hz(30Hz)/PAL: 50Hz(25Hz) flicker.

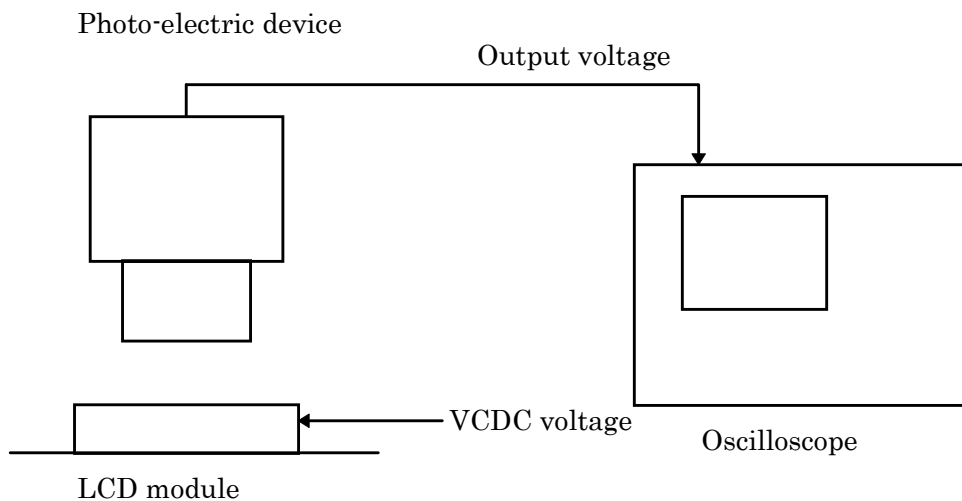

Fig. A Measurement system

《Measurement of flicker》

Photo-electric output voltage is measured by an oscilloscope at a system shown in Fig.A. DC bias voltage must be adjusted so as to minimize the 60Hz(30Hz)[NTSC]/50Hz(25Hz)[PAL] flicker with DC bias voltage changing slowly. (Fig. B)

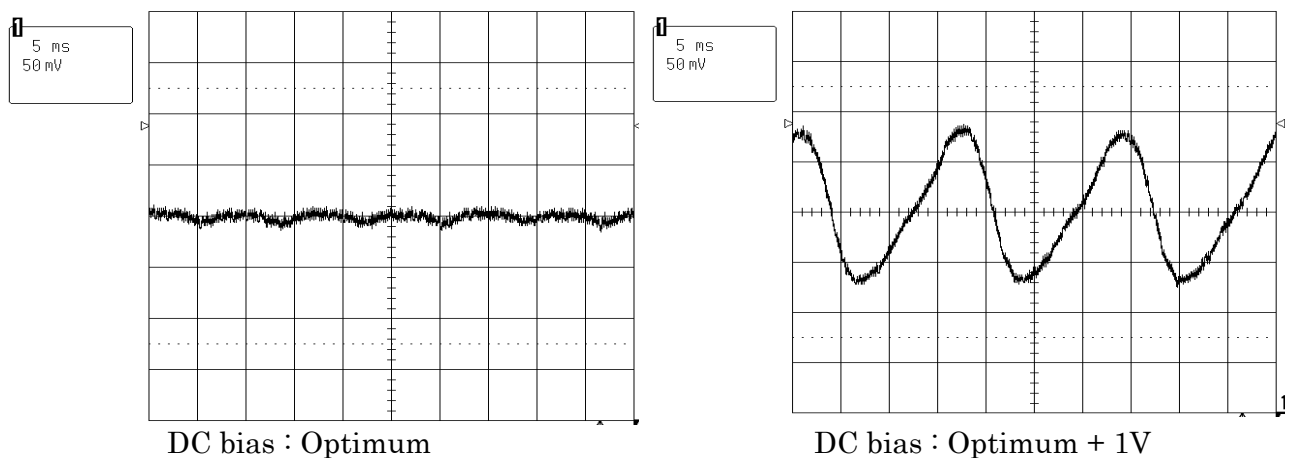

Fig. B Waveforms of flickers

SPECIFICATIONS ARE SUBJECT TO CHANGE WITHOUT NOTICE.

Suggested applications (if any) are for standard use; See Important Restrictions for limitations on special applications. See Limited Warranty for SHARP's product warranty. The Limited Warranty is in lieu, and exclusive of, all other warranties, express or implied. ALL EXPRESS AND IMPLIED WARRANTIES, INCLUDING THE WARRANTIES OF MERCHANTABILITY, FITNESS FOR USE AND FITNESS FOR A PARTICULAR PURPOSE, ARE SPECIFICALLY EXCLUDED. In no event will SHARP be liable, or in any way responsible, for any incidental or consequential economic or property damage.

SHARP®

NORTH AMERICA

SHARP Microelectronics of the Americas
5700 NW Pacific Rim Blvd.
Camas, WA 98607, U.S.A.
Phone: (1) 360-834-2500
Fax: (1) 360-834-8903
Fast Info: (1) 800-833-9437
www.sharpsma.com

EUROPE

SHARP Microelectronics Europe
Division of Sharp Electronics (Europe) GmbH
Sonninstrasse 3
20097 Hamburg, Germany
Phone: (49) 40-2376-2286
Fax: (49) 40-2376-2232
www.sharpsme.com

JAPAN

SHARP Corporation
Electronic Components & Devices
22-22 Nagaike-cho, Abeno-Ku
Osaka 545-8522, Japan
Phone: (81) 6-6621-1221
Fax: (81) 6117-725300/6117-725301
www.sharp-world.com

TAIWAN

SHARP Electronic Components
(Taiwan) Corporation
8F-A, No. 16, Sec. 4, Nanking E. Rd.
Taipei, Taiwan, Republic of China
Phone: (886) 2-2577-7341
Fax: (886) 2-2577-7326/2-2577-7328

SINGAPORE

SHARP Electronics (Singapore) PTE., Ltd.
438A, Alexandra Road, #05-01/02
Alexandra Technopark,
Singapore 119967
Phone: (65) 271-3566
Fax: (65) 271-3855

KOREA

SHARP Electronic Components
(Korea) Corporation
RM 501 Geosung B/D, 541
Dohwa-dong, Mapo-ku
Seoul 121-701, Korea
Phone: (82) 2-711-5813 ~ 8
Fax: (82) 2-711-5819

CHINA

SHARP Microelectronics of China
(Shanghai) Co., Ltd.
28 Xin Jin Qiao Road King Tower 16F
Pudong Shanghai, 201206 P.R. China
Phone: (86) 21-5854-7710/21-5834-6056
Fax: (86) 21-5854-4340/21-5834-6057

Head Office:

No. 360, Bashen Road,
Xin Development Bldg. 22
Waigaoqiao Free Trade Zone Shanghai
200131 P.R. China
Email: smc@china.global.sharp.co.jp

HONG KONG

SHARP-ROXY (Hong Kong) Ltd.
3rd Business Division,
17/F, Admiralty Centre, Tower 1
18 Harcourt Road, Hong Kong
Phone: (852) 28229311
Fax: (852) 28660779
www.sharp.com.hk

Shenzhen Representative Office:

Room 13B1, Tower C,
Electronics Science & Technology Building
Shen Nan Zhong Road
Shenzhen, P.R. China
Phone: (86) 755-3273731
Fax: (86) 755-3273735