

**PLEASE CHECK WWW.MOLEX.COM FOR LATEST PART INFORMATION**

**Part Number:** [0874271692](#)  
**Status:** **Active**  
**Overview:** [minifit\\_jr](#)  
**Description:** 4.20mm (.165") Mini-Fit Jr.™ Header, Vertical, Nylon, with Flange, 16 Circuits, Tin (Sn) over Nickel (Ni) Plating, Glow Wire Compatible

**Documents:**

[3D Model](#) [Product Specification PS-87427-0001 \(PDF\)](#)  
[Drawing \(PDF\)](#) [RoHS Certificate of Compliance \(PDF\)](#)

**General**

|                |   |
|----------------|---|
| Product Family | PCB Headers   |
| Series         | <a href="#">87427</a>   |
| Application    | Wire-to-Board   |
| Comments       | Current = 13A max. per circuit when header is mated to a receptacle loaded with <a href="#">45750</a> Mini-Fit Plus HCS™ Crimp Terminal Crimped to to 16 AWG wire. . See Molex product specification PS-45750-001 for additional current de-rating information. |
| Overview       | <a href="#">minifit_jr</a>  |
| Product Name   | Mini-Fit Jr.™   |

**Physical**

|                                |          |
|--------------------------------|----------|
| Breakaway                      | No       |
| Circuits (Loaded)              | 16       |
| Color - Resin                  | Beige    |
| Durability (mating cycles max) | 30       |
| First Mate / Last Break        | No       |
| Glow-Wire Compliant            | Yes      |
| Lock to Mating Part            | Yes      |
| Material - Metal               | Brass    |
| Material - Plating Mating      | Tin      |
| Material - Plating Termination | Tin      |
| Material - Resin               | Nylon    |
| Number of Rows                 | 2        |
| Orientation                    | Vertical |
| PC Tail Length (in)            | 0.130 In |
| PC Tail Length (mm)            | 3.30 mm  |
| PCB Locator                    | No       |
| PCB Retention                  | None     |
| PCB Thickness Recommended (in) | 0.062 In |
| PCB Thickness Recommended (mm) | 1.60 mm  |
| Packaging Type                 | Tray     |
| Pitch - Mating Interface (in)  | 0.165 In |
| Pitch - Mating Interface (mm)  | 4.20 mm  |
| Pitch - Term. Interface (in)   | 0.165 In |
| Pitch - Term. Interface (mm)   | 4.20 mm  |
| Plating min: Mating (µin)      | 101.6    |
| Plating min: Mating (µm)       | 2.54     |
| Plating min: Termination (µin) | 101.6    |
| Plating min: Termination (µm)  | 2.54     |
| Polarized to Mating Part       | Yes      |
| Polarized to PCB               | No       |
| Shrouded                       | Fully    |
| Stackable                      | No       |
| Surface Mount Compatible (SMC) | No       |

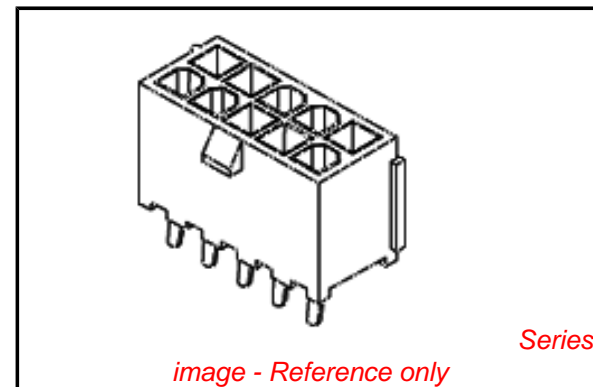

**EU RoHS**

**ELV and RoHS Compliant**  
**REACH SVHC Contains SVHC: No**  
**Halogen-Free Status**  
**Not Reviewed**

**China RoHS**



**Need more information on product environmental compliance?**

Email [productcompliance@molex.com](mailto:productcompliance@molex.com)  
 For a multiple part number RoHS Certificate of Compliance, [click here](#)

Please visit the [Contact Us](#) section for any non-product compliance questions.

**Search Parts in this Series**

[87427Series](#)

**Mates With**

[5557](#) Mini-Fit Jr.™ Receptacle Housing

Temperature Range - Operating -40°C to +105°C  
Termination Interface: Style Through Hole

### **Electrical**

Current - Maximum per Contact 13A  
Voltage - Maximum 600V

### **Solder Process Data**

Duration at Max. Process Temperature (seconds) 30  
Lead-free Process Capability SMC & Wave Capable (TH only)  
Max. Cycles at Max. Process Temperature 2  
Process Temperature max. C 240

### **Material Info**

### **Reference - Drawing Numbers**

Product Specification PS-87427-0001

This document was generated on 05/31/2010

**PLEASE CHECK [WWW.MOLEX.COM](http://WWW.MOLEX.COM) FOR LATEST PART INFORMATION**

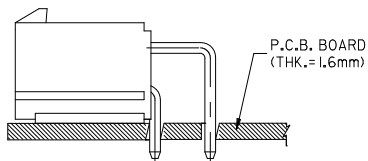
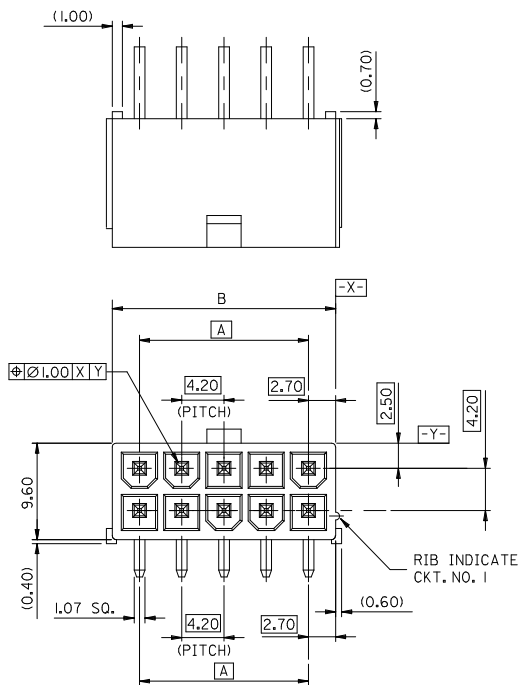

**RECOMMENDED INSTALLATION PATTERN**

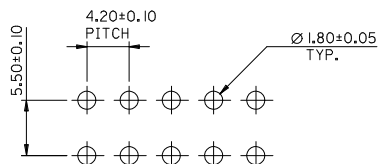

**RECOMMENDED P.C.B. LAYOUT**

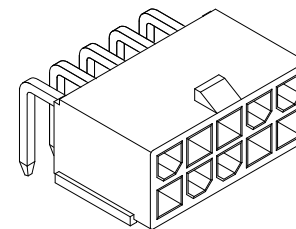

**ISOMETRIC VIEW**

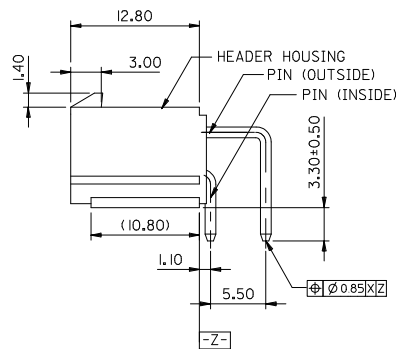

**LEGEND**

- 87427-\*\*\*\*
- CKT. SIZE (SEE SHEET 2).
  - PLATING OPTIONS
    - 2 = NOTE 2
    - 3 = NOTE 3
  - PACKAGING OPTIONS
    - 0 = TRAY PACKED
    - 2 = TUBE PACKED

**NOTES**

1. MATERIAL - HEADER : NYLON 46, UL94V-0, COLOR BEIGE  
PIN : BRASS (1.07 SQUARE)
2. PLATING OF PIN  
TIN 2.54um MIN. OVER NICKEL 1.27um MIN.
3. PLATING OF PIN  
TIN 4-10um OVER COPPER 2-8um.
4. PLATING OF PIN  
TIN 2.54um MIN. OVER NICKEL 1.27um MIN. WITH MATT FINISH.
5. PART NUMBERS 36633-0020 TO 36633-0024 & 36633-0040 TO 36633-0046 INCLUDED AS SHOWN IN TABLE 'X'.

|   |                 |                                       |                |                            |  |                    |   |                               |
|---|-----------------|---------------------------------------|----------------|----------------------------|--|--------------------|---|-------------------------------|
| CORRECT TOLERANCE<br>EC NO: UCP2010-0395<br>DRAWN: JAGUILAR 2010/04/09<br>CHKD: EDMUD 1995/03/01<br>APPR: FSMITH 2010/04/09 | QUALITY SYMBOLS | GENERAL TOLERANCES (UNLESS SPECIFIED) |                | DIMENSION STYLE<br>MM ONLY |  | SCALE<br>2:1       | DESIGN UNITS<br>METRIC  | THIRD ANGLE PROJECTION        |
|   | REV             | DESCRIPTION                           | mm             | INCH                       | DRAWN BY<br>STEVEN   | DATE<br>1995/02/27 | TITLE<br>4.2MM W-T-B HIGH TEMP.<br>RIGHT ANGLE HEADER<br>WITHOUT MOUNTING FLANGES   |                               |
|   | ▽=0             |                                       | 4 PLACES ±---  | ±---                       | CHECKED BY<br>EDMUD  | DATE<br>1995/03/01 | MOLEX INCORPORATED  |                               |
|   | ⊕=0             |                                       | 3 PLACES ±---  | ±---                       | APPROVED BY<br>FSMITH                                      | DATE<br>2010/04/09 |   | DOCUMENT NO.<br>SD-87427-**0* |
|   |                 |                                       | 2 PLACES ±0.20 | ±---                       | MATERIAL NO.<br>SEE CHART                                  |                    |   |                               |
|   |                 |                                       | 1 PLACE ±0.20  | ±---                       | DRAFT WHERE APPLICABLE<br>MUST REMAIN<br>WITHIN DIMENSIONS |                    |   |                               |
|   |                 |                                       | ANGULAR ±---°  |                            | SIZE<br>A3   |                    | THIS DRAWING CONTAINS INFORMATION THAT IS PROPRIETARY TO MOLEX INCORPORATED AND SHOULD NOT BE USED WITHOUT WRITTEN PERMISSION |                               |

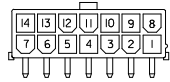

CKT.SIZE 14

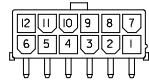

CKT.SIZE 12

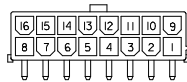

CKT.SIZE 16

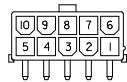

CKT.SIZE 10

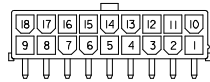

CKT.SIZE 18

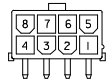

CKT.SIZE 8

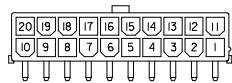

CKT.SIZE 20



CKT.SIZE 6

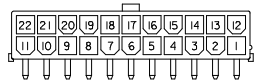

CKT.SIZE 22



CKT.SIZE 4

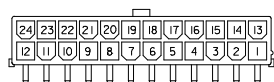

CKT.SIZE 24



CKT.SIZE 2

|   |       |       |            |           |
|---|-------|-------|------------|-----------|
| SEE NOTES $\Delta$<br>ON SHEET 1 FOR<br>PLATING DETAILS | 51.60 | 46.20 | 36633-0046 | 24        |
|   | 47.40 | 42.00 | 36633-0045 | 22        |
|   | 43.20 | 37.80 | 36633-0024 | 20        |
|   | 39.00 | 33.60 | 36633-0044 | 18        |
|   | 34.80 | 29.40 | 36633-0023 | 16        |
|   | 30.60 | 25.20 | 36633-0043 | 14        |
|   | 26.40 | 21.00 | 36633-0022 | 12        |
|   | 22.20 | 16.80 | 36633-0021 | 10        |
|   | 18.00 | 12.60 | 36633-0042 | 8         |
|   | 13.80 | 8.40  | 36633-0041 | 6         |
|   | 9.60  | 4.20  | 36633-0020 | 4         |
|   | 5.40  | --    | 36633-0040 | 2         |
| PIN<br>(OUTSIDE & INSIDE)                               | B     | A     | ENG. NO.   | CKT. SIZE |

TABLE 'X'

|       |       |                         |           |
|-------|-------|-------------------------|-----------|
| 51.60 | 46.20 | 87427-242*              | 24        |
| B     | A     | ENG. NO.<br>TUBE PACKED | CKT. SIZE |
| 51.60 | 46.20 | 87427-240*              | 24        |
| 47.40 | 42.00 | 87427-220*              | 22        |
| 43.20 | 37.80 | 87427-200*              | 20        |
| 39.00 | 33.60 | 87427-180*              | 18        |
| 34.80 | 29.40 | 87427-160*              | 16        |
| 30.60 | 25.20 | 87427-140*              | 14        |
| 26.40 | 21.00 | 87427-120*              | 12        |
| 22.20 | 16.80 | 87427-100*              | 10        |
| 18.00 | 12.60 | 87427-080*              | 8         |
| 13.80 | 8.40  | 87427-060*              | 6         |
| 9.60  | 4.20  | 87427-040*              | 4         |
| 5.40  | --    | 87427-020*              | 2         |
| B     | A     | ENG. NO.<br>TRAY PACKED | CKT. SIZE |

|   |  |   |  |   |   |
|---|--|---|--|---|---|
| EC NO: I2009-0573<br>DRWN: HMR01 2009/11/11<br>CHKD: KPRASAD 2009/11/12<br>APPR: KPRASAD 2009/11/13 | QUALITY SYMBOLS<br>$\nabla=0$<br>$\square=0$ | GENERAL TOLERANCES (UNLESS SPECIFIED)<br>mm INCH<br>4 PLACES $\pm$ --- $\pm$ ---<br>3 PLACES $\pm$ --- $\pm$ ---<br>2 PLACES $\pm$ 0.20 $\pm$ ---<br>1 PLACE $\pm$ 0.20 $\pm$ ---<br>ANGULAR $\pm$ ---° | DIMENSION STYLE<br>MM ONLY<br>DRAWN BY: SAMC DATE: 1996/02/05<br>CHECKED BY: DATE: | SCALE: 1:1<br>DESIGN UNITS: METRIC<br>THIRD ANGLE PROJECTION                                    |   |
|   |  | DRAFT WHERE APPLICABLE MUST REMAIN WITHIN DIMENSIONS  | MATERIAL NO.: SEE CHART<br>SIZE: A3  | TITLE: 4.2MM W-T-B,HIGH TEMP. RIGHT ANGLE HEADER WITHOUT MOUNTING FLANGES<br>MOLEX INCORPORATED | DOCUMENT NO.: SD-87427-**-0*<br>SHEET NO.: 2 OF 2 |
|   |  | THIS DRAWING CONTAINS INFORMATION THAT IS PROPRIETARY TO MOLEX INCORPORATED AND SHOULD NOT BE USED WITHOUT WRITTEN PERMISSION   |  |   |   |
|   |  | REV DESCRIPTION   |  |   |   |