

IRF7910PbF

HEXFET® Power MOSFET

Applications

- High Frequency 3.3V and 5V input Point-of-Load Synchronous Buck Converters for Netcom and Computing Applications
- Power Management for Netcom, Computing and Portable Applications
- Lead-Free

Benefits

- Ultra-Low Gate Impedance
- Very Low $R_{DS(on)}$
- Fully Characterized Avalanche Voltage and Current

V_{DSS}	$R_{DS(on)}$ max	I_D
12V	15m Ω @ $V_{GS} = 4.5V$	10A

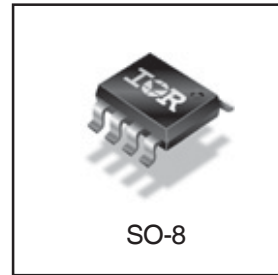
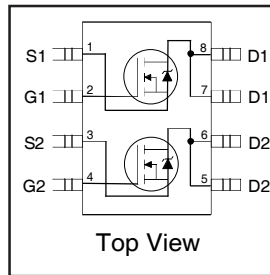

Absolute Maximum Ratings

Symbol	Parameter	Max.	Units
V_{DS}	Drain-Source Voltage	12	V
V_{GS}	Gate-to-Source Voltage	± 12	V
$I_D @ T_A = 25^\circ C$	Continuous Drain Current, $V_{GS} @ 4.5V$	10	A
$I_D @ T_A = 70^\circ C$	Continuous Drain Current, $V_{GS} @ 4.5V$	7.9	
I_{DM}	Pulsed Drain Current ^①	79	
$P_D @ T_A = 25^\circ C$	Maximum Power Dissipation ^④	2.0	W
$P_D @ T_A = 70^\circ C$	Maximum Power Dissipation ^④	1.3	W
	Linear Derating Factor	16	mW/ $^\circ C$
T_J, T_{STG}	Junction and Storage Temperature Range	-55 to + 150	$^\circ C$

Thermal Resistance

Symbol	Parameter	Typ.	Max.	Units
$R_{\theta JL}$	Junction-to-Drain Lead	—	42	$^\circ C/W$
$R_{\theta JA}$	Junction-to-Ambient ^④	—	62.5	

Notes ^① through ^④ are on page 8
www.irf.com

IRF7910PbF

International
IR Rectifier

Static @ $T_J = 25^\circ\text{C}$ (unless otherwise specified)

Symbol	Parameter	Min.	Typ.	Max.	Units	Conditions
$V_{(BR)DSS}$	Drain-to-Source Breakdown Voltage	12	—	—	V	$V_{GS} = 0V, I_D = 250\mu A$
$\Delta V_{(BR)DSS}/\Delta T_J$	Breakdown Voltage Temp. Coefficient	—	0.01	—	V/°C	Reference to $25^\circ\text{C}, I_D = 1\text{mA}$
$R_{DS(on)}$	Static Drain-to-Source On-Resistance	—	11.5	15	mΩ	$V_{GS} = 4.5V, I_D = 8.0A$ ③
		—	20	50		$V_{GS} = 2.8V, I_D = 5.0A$
$V_{GS(th)}$	Gate Threshold Voltage	0.6	—	2.0	V	$V_{DS} = V_{GS}, I_D = 250\mu A$
I_{DSS}	Drain-to-Source Leakage Current	—	—	100	μA	$V_{DS} = 9.6V, V_{GS} = 0V$
		—	—	250		$V_{DS} = 9.6V, V_{GS} = 0V, T_J = 125^\circ\text{C}$
I_{GSS}	Gate-to-Source Forward Leakage	—	—	200	nA	$V_{GS} = 12V$
	Gate-to-Source Reverse Leakage	—	—	-200		$V_{GS} = -12V$

Dynamic @ $T_J = 25^\circ\text{C}$ (unless otherwise specified)

Symbol	Parameter	Min.	Typ.	Max.	Units	Conditions
g_{fs}	Forward Transconductance	18	—	—	S	$V_{DS} = 6.0V, I_D = 8.0A$
Q_g	Total Gate Charge	—	17	26	nC	$I_D = 8.0A$
Q_{gs}	Gate-to-Source Charge	—	4.4	—		$V_{DS} = 6.0V$
Q_{gd}	Gate-to-Drain ("Miller") Charge	—	5.2	—		$V_{GS} = 4.5V$
Q_{oss}	Output Gate Charge	—	16	—		$V_{GS} = 0V, V_{DS} = 10V$
$t_{d(on)}$	Turn-On Delay Time	—	9.4	—	ns	$V_{DD} = 6.0V$
t_r	Rise Time	—	22	—		$I_D = 8.0A$
$t_{d(off)}$	Turn-Off Delay Time	—	16	—		$R_G = 1.8\Omega$
t_f	Fall Time	—	6.3	—		$V_{GS} = 4.5V$ ③
C_{iss}	Input Capacitance	—	1730	—	pF	$V_{GS} = 0V$
C_{oss}	Output Capacitance	—	1340	—		$V_{DS} = 6.0V$
C_{rss}	Reverse Transfer Capacitance	—	330	—		$f = 1.0\text{MHz}$

Avalanche Characteristics

Symbol	Parameter	Typ.	Max.	Units
E_{AS}	Single Pulse Avalanche Energy②	—	100	mJ
I_{AR}	Avalanche Current①	—	8.0	A

Diode Characteristics

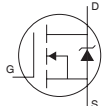
Symbol	Parameter	Min.	Typ.	Max.	Units	Conditions
I_S	Continuous Source Current (Body Diode)	—	—	1.8	A	MOSFET symbol showing the integral reverse p-n junction diode. 
I_{SM}	Pulsed Source Current (Body Diode) ①	—	—	79		
V_{SD}	Diode Forward Voltage	—	0.85	1.3	V	$T_J = 25^\circ\text{C}, I_S = 8.0A, V_{GS} = 0V$ ③
		—	0.70	—		$T_J = 125^\circ\text{C}, I_S = 8.0A, V_{GS} = 0V$ ③
t_{rr}	Reverse Recovery Time	—	50	75	ns	$T_J = 25^\circ\text{C}, I_F = 8.0A, V_R = 12V$
Q_{rr}	Reverse Recovery Charge	—	60	90	nC	$di/dt = 100A/\mu s$ ③
t_{rr}	Reverse Recovery Time	—	51	77	ns	$T_J = 125^\circ\text{C}, I_F = 8.0A, V_R = 12V$
Q_{rr}	Reverse Recovery Charge	—	60	90	nC	$di/dt = 100A/\mu s$ ③

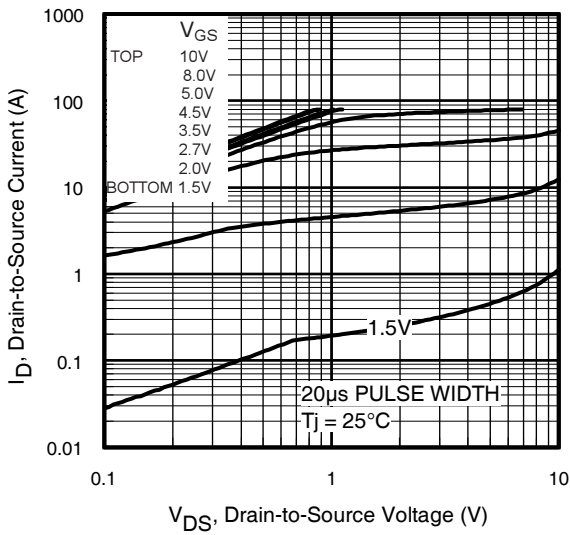

Fig 1. Typical Output Characteristics

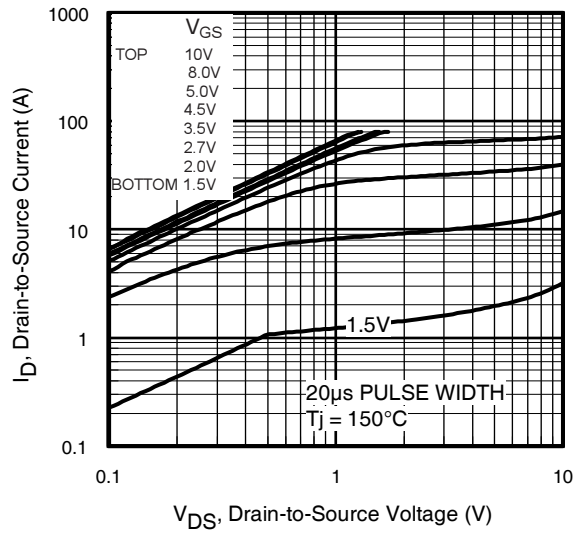

Fig 2. Typical Output Characteristics

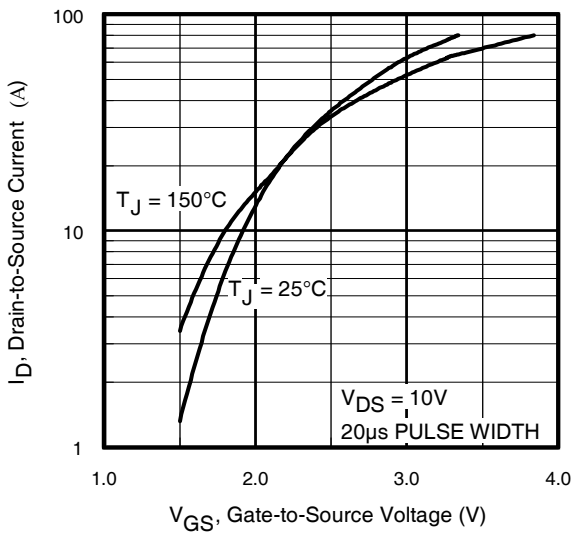

Fig 3. Typical Transfer Characteristics

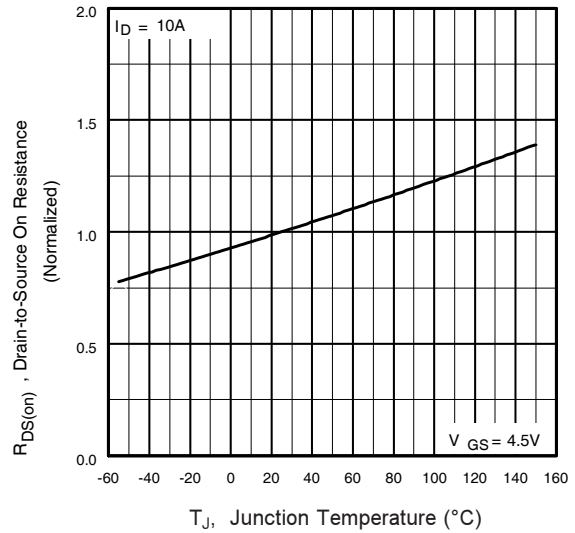

Fig 4. Normalized On-Resistance Vs. Temperature

IRF7910PbF

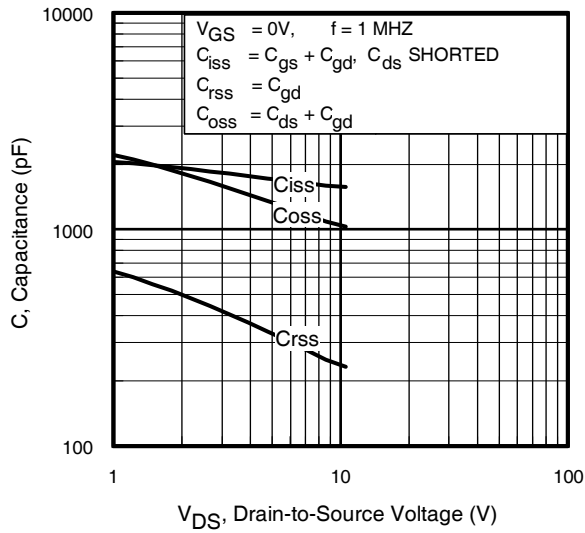

Fig 5. Typical Capacitance Vs. Drain-to-Source Voltage

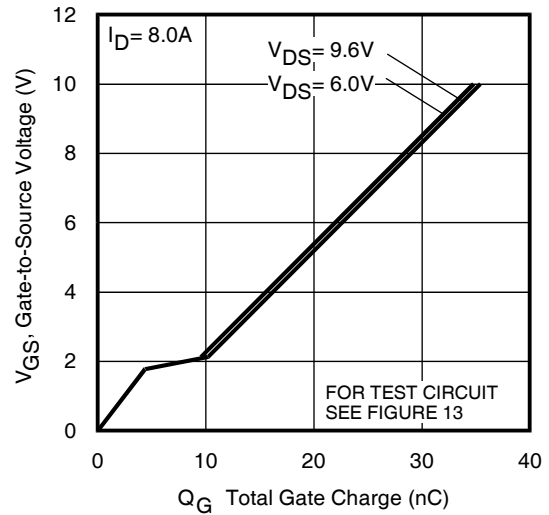

Fig 6. Typical Gate Charge Vs. Gate-to-Source Voltage

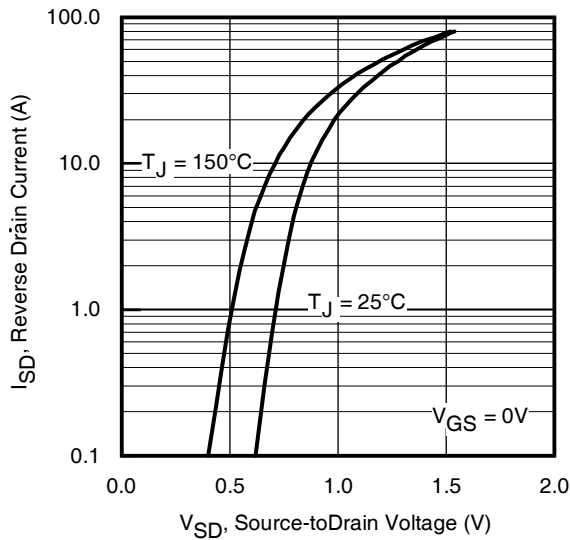

Fig 7. Typical Source-Drain Diode Forward Voltage

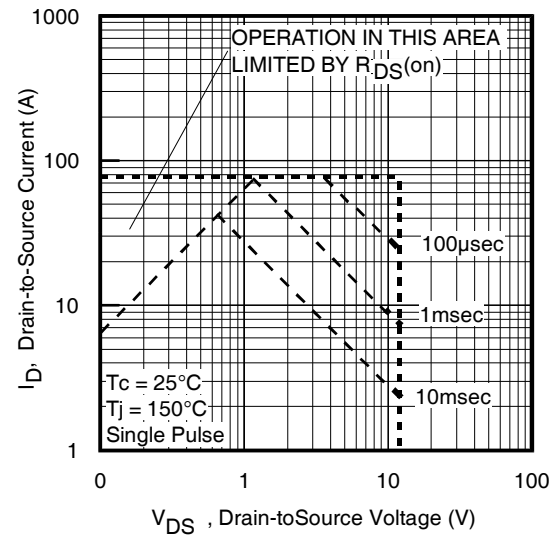

Fig 8. Maximum Safe Operating Area

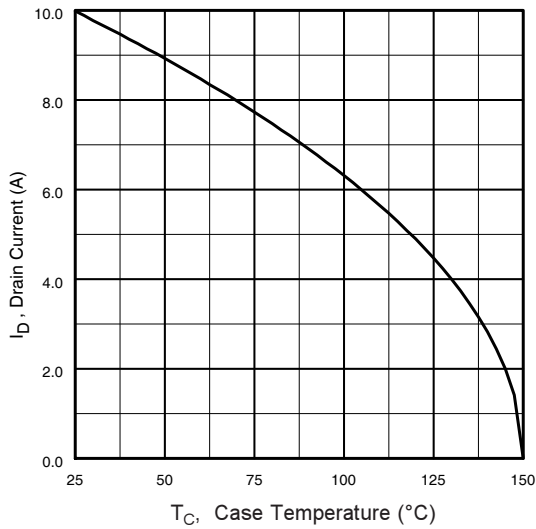

Fig 9. Maximum Drain Current Vs. Ambient Temperature

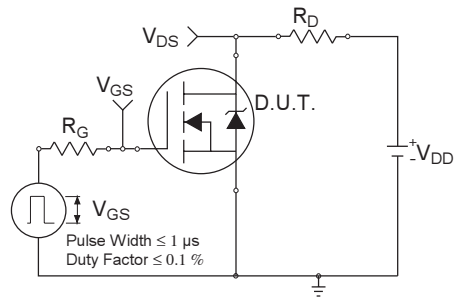

Fig 10a. Switching Time Test Circuit



Fig 10b. Switching Time Waveforms

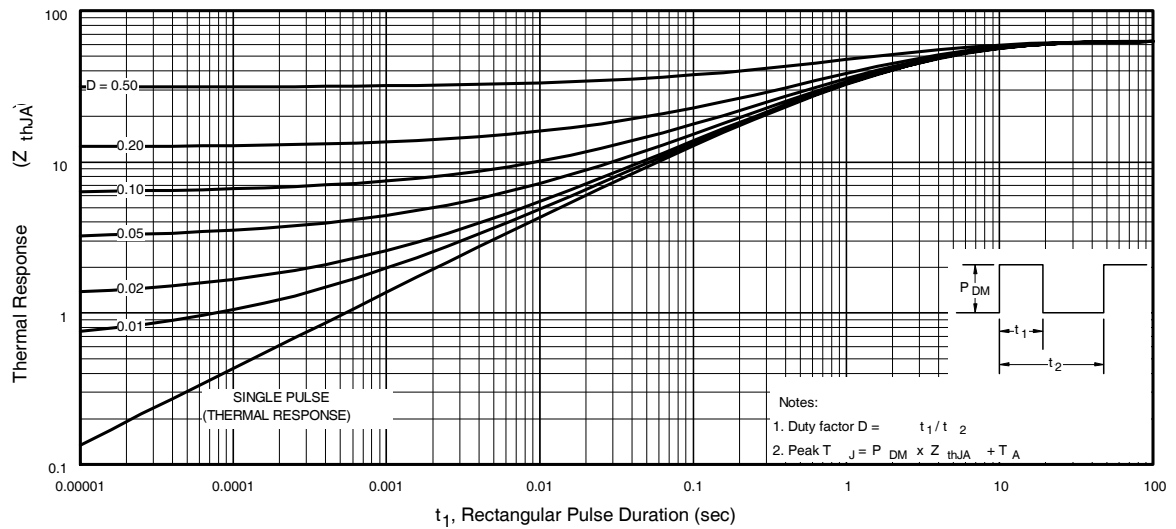

Fig 11. Maximum Effective Transient Thermal Impedance, Junction-to-Ambient

IRF7910PbF

International
IR Rectifier

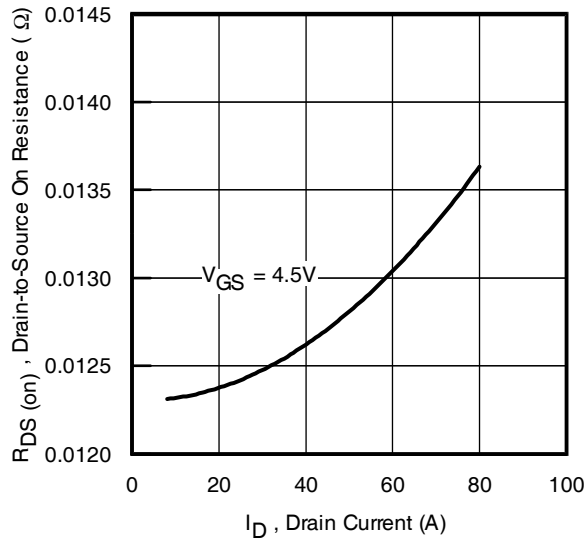

Fig 12. On-Resistance Vs. Drain Current

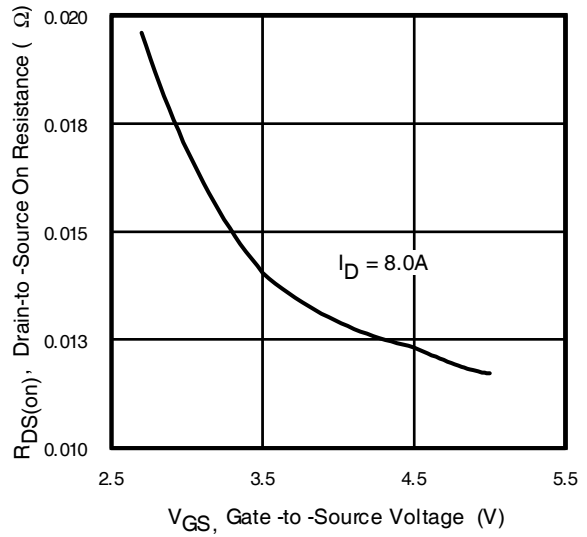

Fig 13. On-Resistance Vs. Gate Voltage

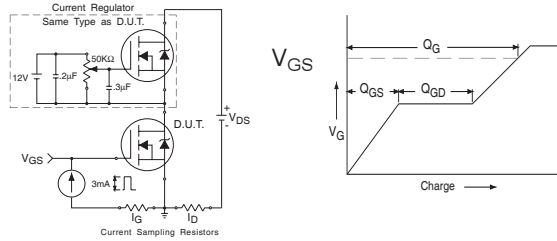

Fig 14a&b. Basic Gate Charge Test Circuit and Waveform

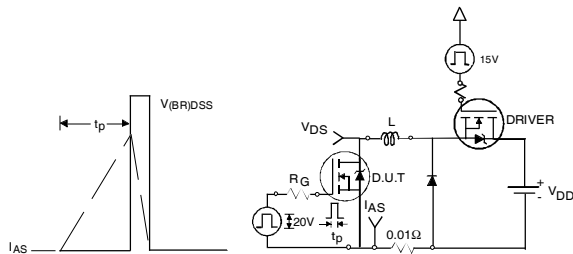

Fig 15a&b. Unclamped Inductive Test circuit and Waveforms

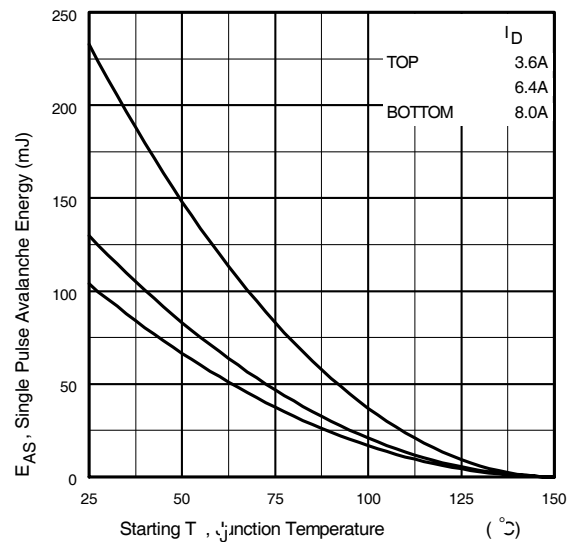
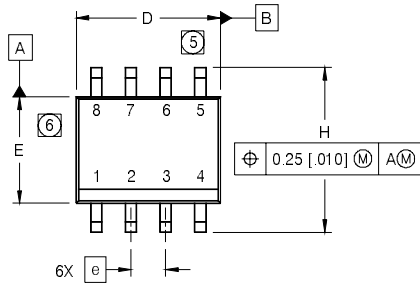

Fig 15c. Maximum Avalanche Energy Vs. Drain Current

SO-8 Package Outline (MOSFET & Fetky)

Dimensions are shown in millimeters (inches)



DIM	INCHES		MILLIMETERS	
	MIN	MAX	MIN	MAX
A	.0532	.0688	1.35	1.75
A1	.0040	.0098	0.10	0.25
b	.013	.020	0.33	0.51
c	.0075	.0098	0.19	0.25
D	.189	.1968	4.80	5.00
E	.1497	.1574	3.80	4.00
e	.050 BASIC		1.27 BASIC	
e1	.025 BASIC		0.635 BASIC	
H	.2284	.2440	5.80	6.20
K	.0099	.0196	0.25	0.50
L	.016	.050	0.40	1.27
y	0°	8°	0°	8°

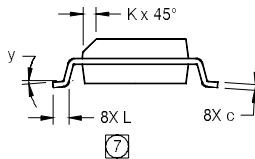
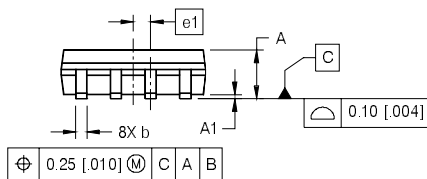

NOTES:

1. DIMENSIONING & TOLERANCING PER ASME Y14.5M-1994.
2. CONTROLLING DIMENSION: MILLIMETER
3. DIMENSIONS ARE SHOWN IN MILLIMETERS [INCHES].
4. OUTLINE CONFORMS TO JEDEC OUTLINE MS-012AA
- ⑤ DIMENSION DOES NOT INCLUDE MOLD PROTRUSIONS. MOLD PROTRUSIONS NOT TO EXCEED 0.15 [0.006].
- ⑥ DIMENSION DOES NOT INCLUDE MOLD PROTRUSIONS. MOLD PROTRUSIONS NOT TO EXCEED 0.25 [0.010].
- ⑦ DIMENSION IS THE LENGTH OF LEAD FOR SOLDERING TO A SUBSTRATE.

FOOTPRINT

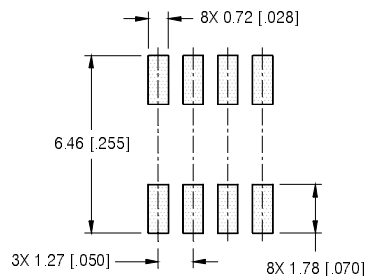

SO-8 Part Marking Information

EXAMPLE: THIS IS AN IRF7101 (MOSFET)

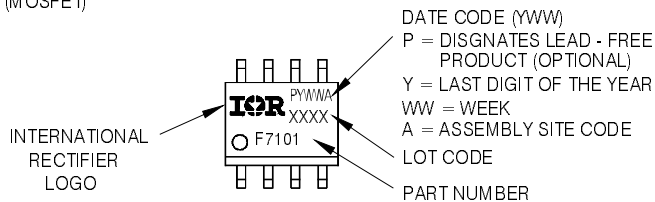

Note: For the most current drawing please refer to IR website at: <http://www.irf.com/package/>
www.irf.com

IRF7910PbF

SO-8 Tape and Reel

Dimensions are shown in millimeters (inches)

International
IR Rectifier

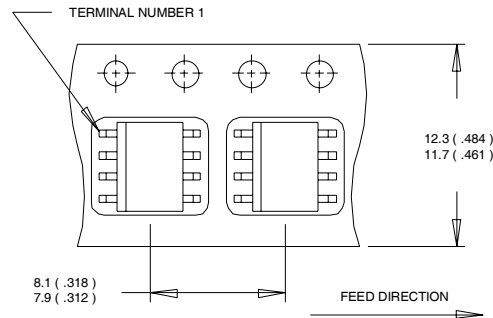

- NOTES:
1. CONTROLLING DIMENSION : MILLIMETER.
 2. ALL DIMENSIONS ARE SHOWN IN MILLIMETERS(INCHES).
 3. OUTLINE CONFORMS TO EIA-481 & EIA-541.

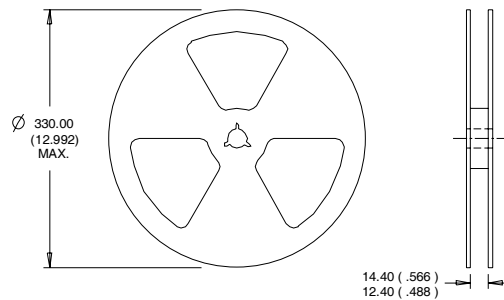

- NOTES:
1. CONTROLLING DIMENSION : MILLIMETER.
 2. OUTLINE CONFORMS TO EIA-481 & EIA-541.

Note: For the most current drawing please refer to IR website at: <http://www.irf.com/package/>

Notes:

- ① Repetitive rating; pulse width limited by max. junction temperature.
- ② Starting $T_J = 25^\circ\text{C}$, $L = 3.2\text{mH}$
 $R_G = 25\Omega$, $I_{AS} = 8.0\text{A}$.
- ③ Pulse width $\leq 300\mu\text{s}$; duty cycle $\leq 2\%$.
- ④ When mounted on 1 inch square copper board, $t < 10$ sec

Data and specifications subject to change without notice.
This product has been designed and qualified for the Consumer market.
Qualifications Standards can be found on IR's Web site.

International
IR Rectifier

IR WORLD HEADQUARTERS: 233 Kansas St., El Segundo, California 90245, USA Tel: (310) 252-7105
TAC Fax: (310) 252-7903

Visit us at www.irf.com for sales contact information.07/2008

www.irf.com