



ULTRA HIGH VOLTAGE OPERATIONAL AMPLIFIER

162/163

M.S.KENNEDY CORP.

4707 Dey Road Liverpool, N.Y. 13088

(315) 701-6751

MIL-PRF-38534 QUALIFIED

FEATURES:

- Monolithic MOS Technology
- Low Cost
- High Voltage Operation : 350V
- Low Quiescent Current : 2mA Max.
- High Output Current : 60mA Min.
- No Secondary Breakdown
- High Speed : 20V/ μ S Typ.
- Internally Compensated For Gains > 10 V/V

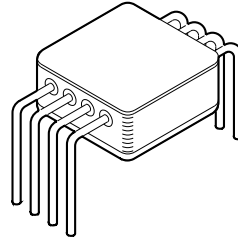

MSK162

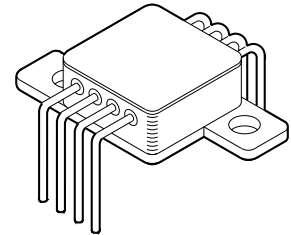

MSK163

DESCRIPTION:

The MSK 162 is an ultra high voltage monolithic MOSFET operational amplifier ideally suited for electrostatic transducer and electrostatic deflection applications. With a total supply voltage rating of 350 volts and 60mA of available output current, the MSK 162 is also an excellent low cost choice for high voltage piezo drive circuits. The MOSFET output frees the MSK 162 from secondary breakdown limitations and power dissipation is kept to a minimum with a quiescent current rating of only 2mA. The MSK 162 is packaged in a hermetically sealed 8 pin power dip and is internally compensated for closed loop gains of 10 V/V or greater. For applications requiring heat sinking, the MSK 163 is available with bolt down tabs and is otherwise identical to the MSK 162 (see mechanical specifications). If the application calls for a gain of less than 10 V/V, refer to the MSK 158/159 data sheet.

EQUIVALENT SCHEMATIC

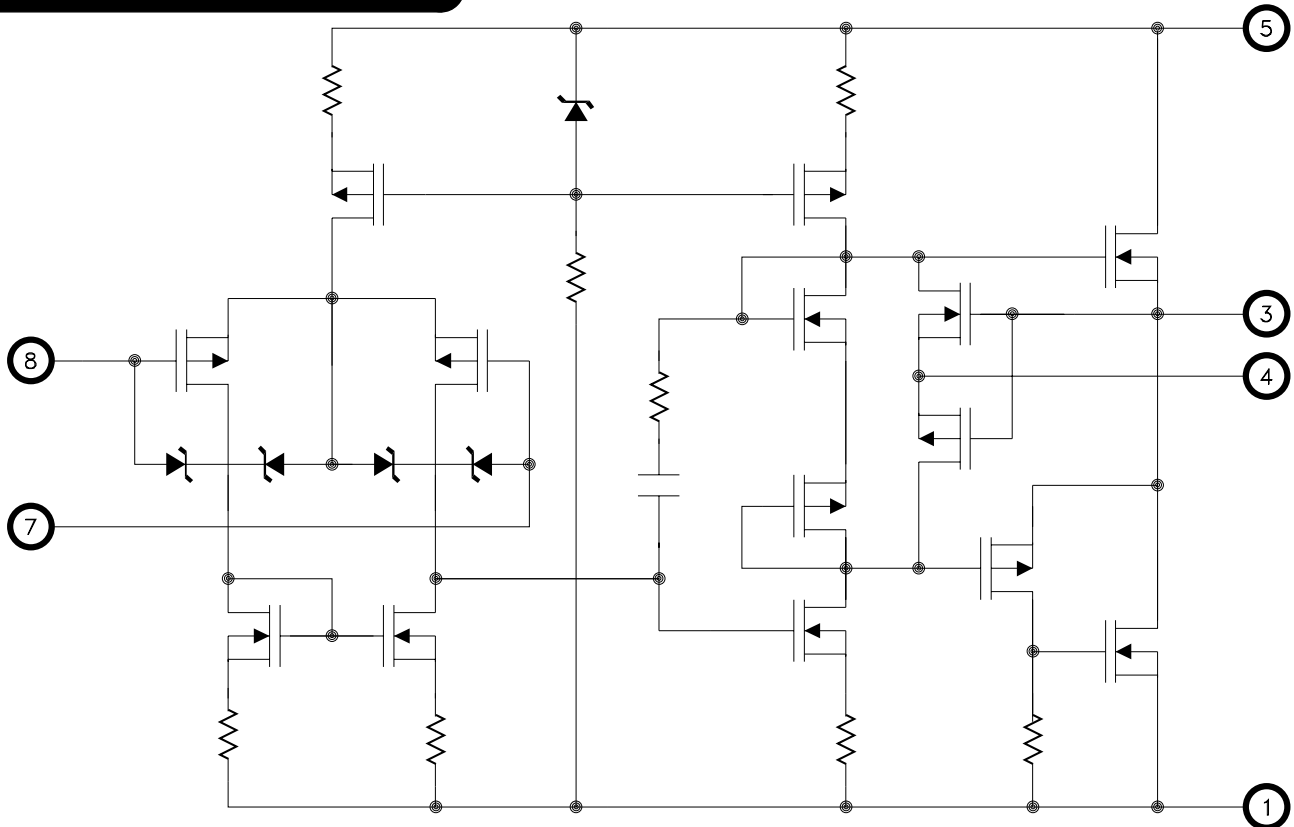

TYPICAL APPLICATIONS

- Piezo Electric Positioning
- Electrostatic Deflection
- Computer to Vacuum Tube Interface
- Ultra High Voltage Op-Amp Applications

PIN-OUT INFORMATION

- | | |
|-----------------|-----------------------|
| 1 -Vcc | 8 Inverting Input |
| 2 NC | 7 Non-Inverting Input |
| 3 Output Drive | 6 NC |
| 4 Current Sense | 5 +Vcc |

ABSOLUTE MAXIMUM RATINGS

V_{CC} ②	Total Supply Voltage	350V	T_{ST}	Storage Temperature	-65°C to +150°C
$\pm I_{OUT}$	Output Current (within S.O.A.)	60mA	T_{LD}	Lead Temperature	300°C
$\pm I_{OUTP}$	Output Current Peak	120mA	T_C	Case Operating Temperature (MSK162B/E/163B/E)	-55°C to +125°C
V_{IND}	Input Voltage (Differential)	$\pm 16V$		(MSK162/163)	-40°C to +85°C
V_{IN}	Input Voltage (Common Mode)	$\pm V_{CC}$	R_{TH}	Thermal Resistance (DC) Junction to Case	11°C/W
T_J	Junction Temperature	150°C			

ELECTRICAL SPECIFICATIONS

Parameter	Test Conditions ①	Group A Subgroup	MSK162B/E/163B/E			MSK162/163			Units
			Min.	Typ.	Max.	Min.	Typ.	Max.	
STATIC									
Supply Voltage Range ② ④ ⑨		-	± 50	± 150	± 175	± 50	± 150	± 175	V
Quiescent Current	$V_{IN} = 0V$	1	-	± 1.4	± 2.0	-	± 1.4	± 2.0	mA
		2	-	± 2.0	± 3.0	-	-	-	mA
		3	-	± 1.0	± 2.1	-	-	-	mA
INPUT									
Offset Voltage	$V_{IN} = 0V$	1	-	± 15	± 30	-	± 15	± 30	mV
Offset Voltage Drift ④	$V_{IN} = 0V$	2,3	-	± 40	± 65	-	± 40	-	$\mu V/^\circ C$
Offset Voltage vs $\pm V_{CC}$ ④	$V_{IN} = 0V$	1	-	± 20	± 32	-	± 20	± 32	$\mu V/V$
Input Bias Current ④	$V_{CM} = 0V$	1	-	± 5	± 50	-	± 5	± 100	pA
		2,3	-	-	± 50	-	-	-	nA
Input Impedance ④	(DC)	-	-	10^{11}	-	-	10^{11}	-	Ω
Input Capacitance ④		-	-	5	-	-	5	-	pF
Common Mode Rejection ④	$V_{CM} = \pm 90VDC$	-	84	94	-	84	94	-	dB
Noise	$1Hz \leq f \leq 10Hz$	-	-	50	-	-	50	-	$\mu VRMS$
OUTPUT									
Output Voltage Swing	$I_{OUT} = \pm 40mA$ Peak	4	± 138	± 141	-	± 138	± 141	-	V
Output Current	$V_{OUT} = MAX$	4	± 60	± 120	-	± 60	± 120	-	mA
Power Bandwidth ④	$V_{OUT} = 280V_{PP}$	-	-	26	-	-	26	-	KHz
Resistance ④	No Load, $R_{CL} = 0\Omega$	-	-	150	-	-	150	-	Ω
Settling Time to 0.1% ③ ④	10V Step	-	-	12	-	-	12	-	μS
Capacitive Load ④	$A_V = +1V/V$	-	10	-	-	10	-	-	nF
TRANSFER CHARACTERISTICS									
Slew Rate	$C_C = Open$	4	10	20	-	10	20	-	$V/\mu S$
Open Loop Voltage Gain ④	$F = 15Hz$ $R_L = 5K\Omega$	4	94	106	-	94	106	-	dB

NOTES:

- ① Unless otherwise noted, $\pm V_{CC} = \pm 150VDC$.
- ② Derate maximum supply voltage 0.5V/°C below $T_C = +25^\circ C$. No derating is needed above $T_C = 25^\circ C$.
- ③ $A_V = -10V/V$ measured in false summing junction circuit.
- ④ Guaranteed by design but not tested. Typical parameters are representative of actual device performance but are for reference only.
- ⑤ Industrial grade and "E" suffix devices shall be tested to subgroups 1 and 4 unless otherwise requested.
- ⑥ Military grade and devices ('B' suffix) shall be 100% tested to subgroups 1,2,3 and 4.
- ⑦ Subgroup 5 and 6 testing available upon request.
- ⑧ Subgroup 1,4 $T_C = +25^\circ C$
Subgroup 2,5 $T_C = +125^\circ C$
Subgroup 3,6 $T_A = -55^\circ C$
- ⑨ Electrical specifications are derated for power supply voltages less than $\pm 50VDC$.

APPLICATION NOTES

CURRENT LIMIT

Current limit resistor value can be calculated as follows:

$$R_{cl} = 3/I_{lim}$$

It is recommended that the user set up the value of current limit as close as possible to the maximum expected output current to protect the amplifier. The minimum value of current limit resistance is 33 ohms. The maximum practical value is 500 ohms. Current limit will vary with case temperature. Refer to the typical performance graphs as a guide. Since load current passes through the current limit resistor, a loss in output voltage swing will occur. The following formula approximates output voltage swing reduction:

$$V_r = I_o * R_{cl}$$

When the device is in current limit, there will be spurious oscillations present on the negative half cycle. The frequency of the oscillation is application dependent and can not be predicted. Oscillation will cease when the device comes out of current limit.

INPUT PROTECTION

Input protection circuitry within the MSK 162/163 will clip differential input voltages greater than 16 volts. The inputs are also protected against common mode voltages up to the supply rails as well as static discharge. There are 300 ohm current limiting resistors in series with each input. These resistors may become damaged in the event the input overload is capable of driving currents above 1mA. If severe overload conditions are expected, external input current limiting resistors are recommended.

OUTPUT SNUBBER NETWORK

A 100 ohm resistor and a 330pF capacitor connected in series from the output of the amplifier to ground is recommended for applications where load capacitance is less than 330pF. For larger values of load capacitance, the output snubber network may be omitted. If loop stability becomes a problem due to excessively high load capacitance, a 100 ohm resistor may be added between the output of the amplifier and the load. A small tradeoff with bandwidth must be made in this configuration. The graph below illustrates the effect of capacitive load. Note that the compensation capacitor must have a voltage rating greater than the total rail to rail power supply voltage.

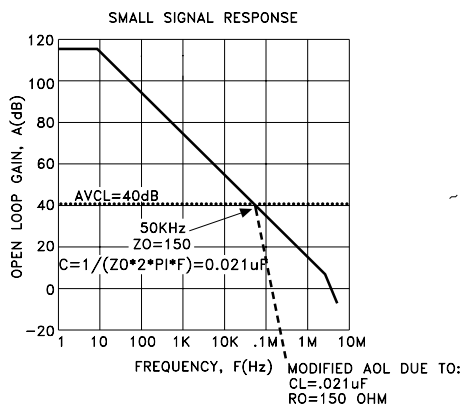

SAFE OPERATING AREA (SOA)

The MOSFET output stage of this power operational amplifier has two distinct limitations:

1. The current handling capability of the die metallization.
2. The temperature of the output MOSFET's.

NOTE: The output stage is protected against transient flyback. However, for protection against sustained, high energy flyback, external fast-recovery reverse biased diodes should be used.

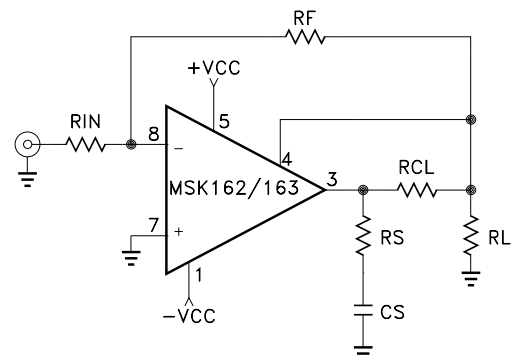
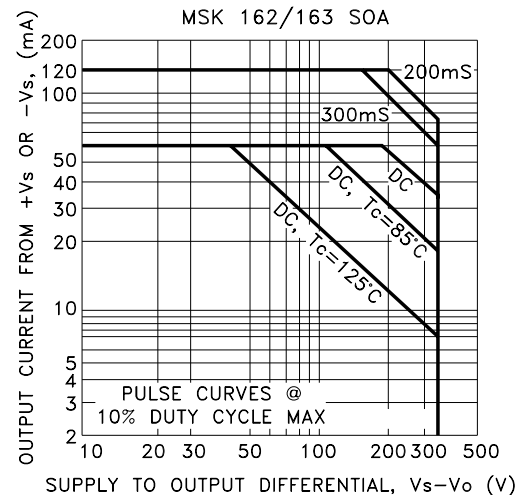

STABILITY

The MSK 162/163 are internally compensated for closed loop gains of 10 V/V or greater. The majority of applications the MSK 162/163 are used in involve gains greater than 10 V/V because the output is capable of swinging up to +/- 141V and the maximum differential input voltage is only +/- 16V. A large gain is necessary to make full use of the output voltage swing capability of the amplifier when input voltages are small. If closed loop gains of less than 10 V/V are required, refer to the MSK 158/159 data sheets. The MSK 158/159 operational amplifiers are identical to the MSK 162/163 except pins two and six are compensation pins. The user can tailor op-amp performance with the external connection of a series resistor-capacitor snubber network. An effective method of checking amplifier stability is to apply the worst case capacitive load to the output of the amplifier and drive a small signal square wave across it. If overshoot is less than 25%, the system will generally be stable.

TYPICAL PERFORMANCE CURVES

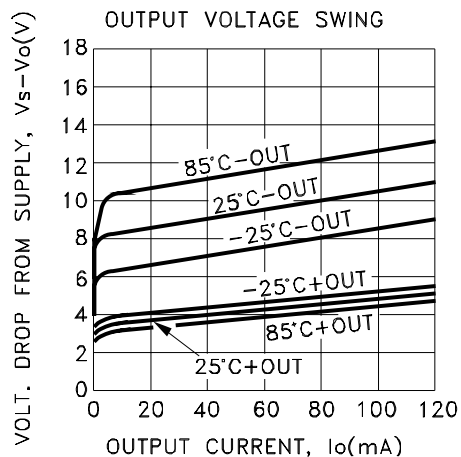
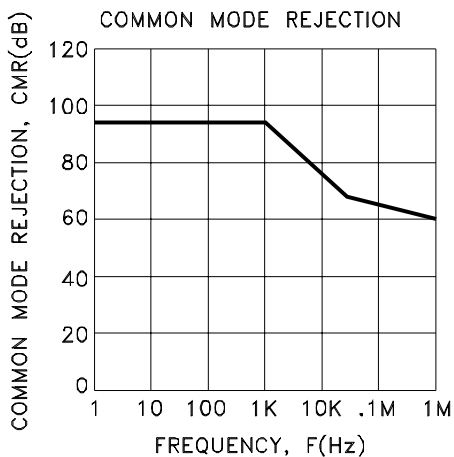
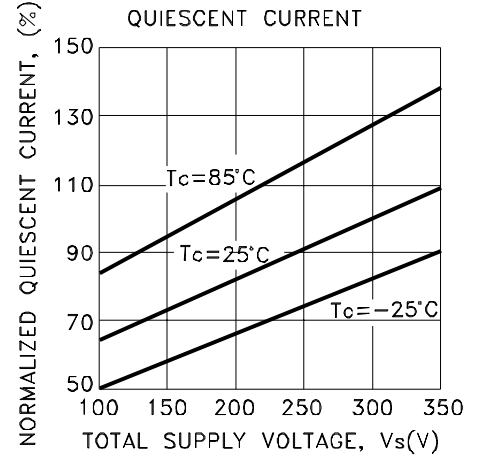
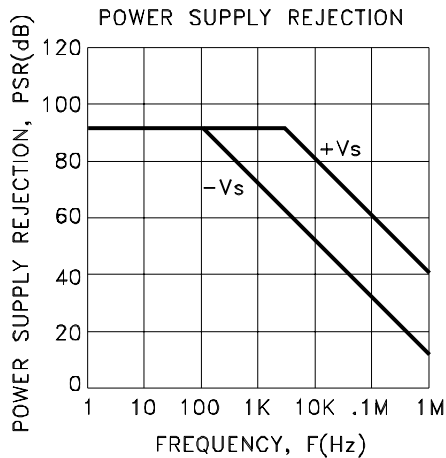
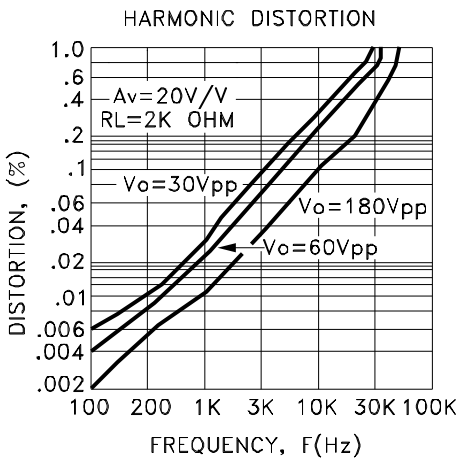
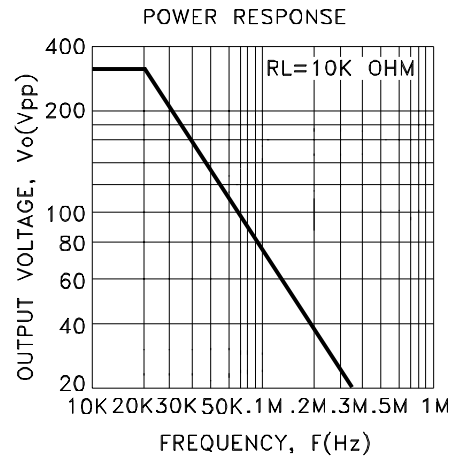
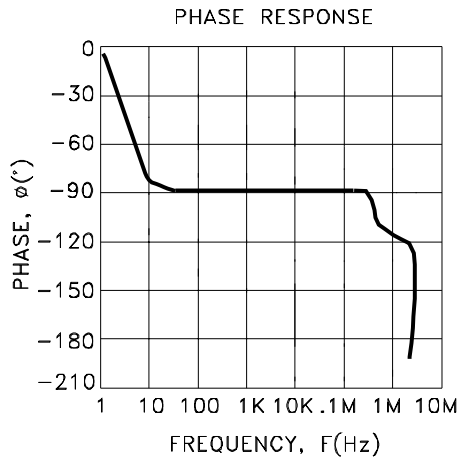
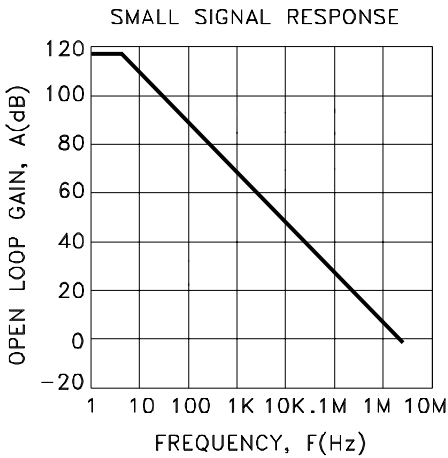
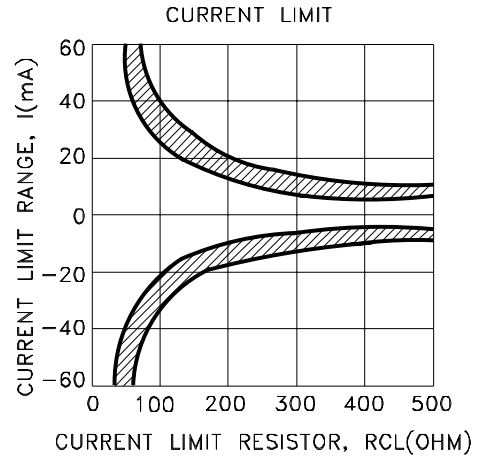
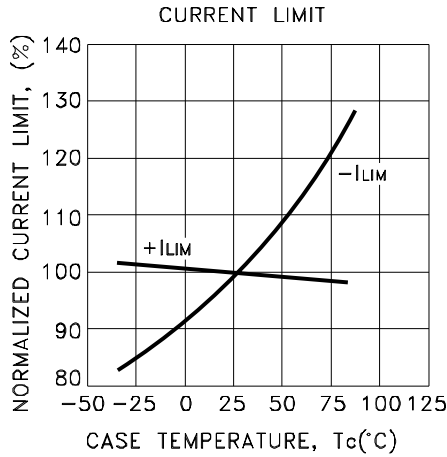
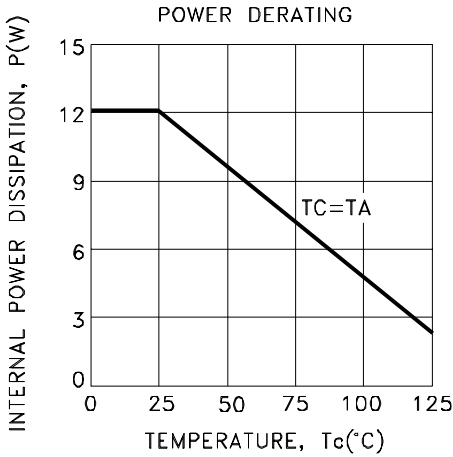

MECHANICAL SPECIFICATIONS

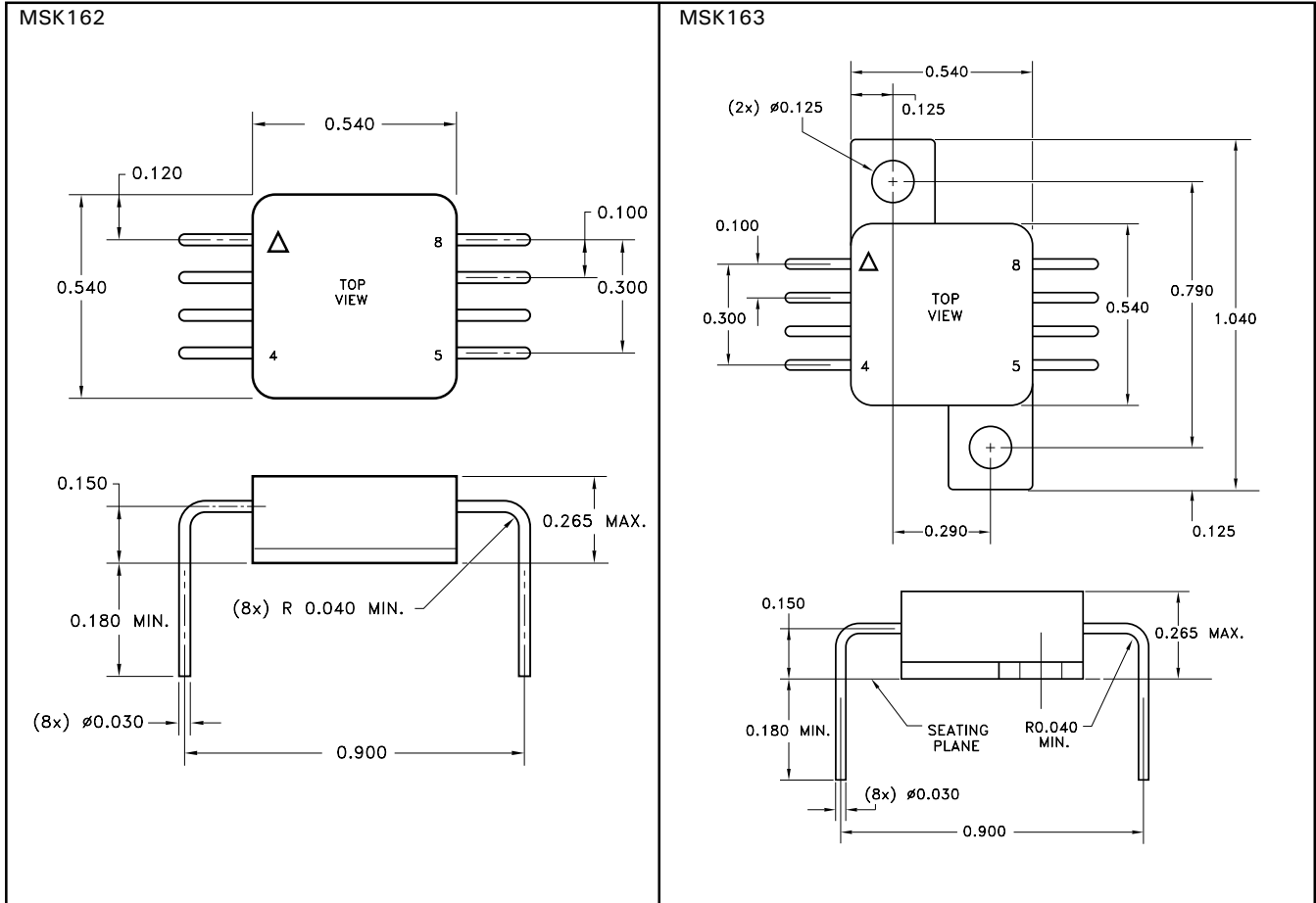

ESD TRIANGLE INDICATES PIN 1.
ALL DIMENSIONS ARE ± 0.010 INCHES UNLESS OTHERWISE LABELED.

ORDERING INFORMATION

Part Number	Screening Level
MSK162	Industrial
MSK162E	Extended Reliability
MSK162B	Mil-PRF-38534 Class H
MSK163	Industrial
MSK163E	Extended Reliability
MSK163B	Mil-PRF-38534 Class H

M.S. Kennedy Corp.
4707 Dey Road, Liverpool, New York 13088
Phone (315) 701-6751
FAX (315) 701-6752
www.mskennedy.com

The information contained herein is believed to be accurate at the time of printing. MSK reserves the right to make changes to its products or specifications without notice, however, and assumes no liability for the use of its products. Please visit our website for the most recent revision of this datasheet.