

SERIES KAJ SWITCHES

LOW-PROFILE DIP SWITCHES

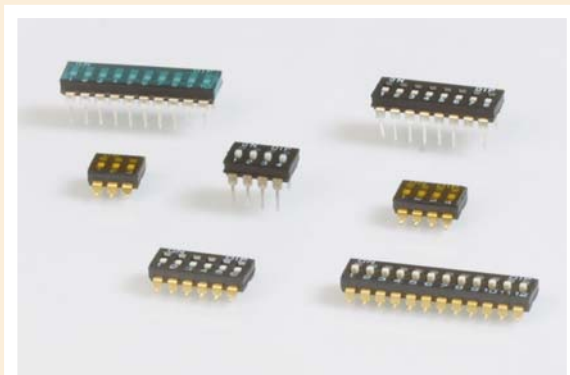

E-SWITCH®



SPECIFICATIONS

| | |
|------------------------|--|
| Switch Function: | 2, 3, 4, 5, 6, 7, 8, 9, 10 & 12 positions |
| Ratings: | Switch: 25mA @ 24 VDC Carry: 100mA @ 50 VDC |
| Contact Resistance: | initial 50mΩ typical @ 2-4 VCD, 100mA |
| Insulation Resistance: | 100 MΩ min. |
| Operating Life: | 2,000 cycles, typical |
| Dielectric Strength: | 500 V rms @ sea level between adjacent terminals |
| Temperature Range: | -40° C to 85° C |

FEATURES & BENEFITS

- ▶ Available in SMT or Thru Hole
- ▶ Tape & reel or tube packaging
- ▶ Up to 12 positions

APPLICATIONS/MARKETS

- ▶ Garage door openers
- ▶ Test & instrumentation
- ▶ Telecommunications
- ▶ Controller application

TYPICAL SMT TEMPERATURE PROFILE

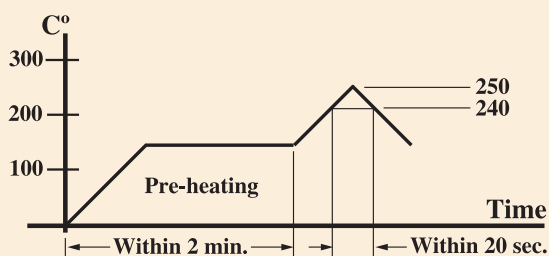

MATERIALS

| | |
|-------------------|-----------------------------|
| Base: | PPS UL94 V0, black finish |
| Cover: | PPS UL94 V0, black finish |
| Actuator: | Nylon UL94 V0, white finish |
| Movable Contact: | Gold-plated copper alloy |
| Terminal Contact: | Gold-plated brass |
| Tape Seal: | Mylar, amber color |

PACKAGING

Switches are supplied in standard IC tubes with all poles in the "OFF" position.

HOW TO ORDER

| SERIES | MODEL NO. | NO. OF POSITIONS | ACTUATOR | TERMINATION | TERMINAL FINISH | PACKAGING |
|--------|-----------------|--|---|--|-----------------|------------------------------------|
| KA | J = Low Profile | 02 = 2 03 = 3 04 = 4 05 = 5 06 = 6 07 = 7 08 = 8 09 = 9 10 = 10 12 = 12 | L = Extended S = Recessed w/o Tape Seal T = Recessed w/ Tape Seal | A = Splayed Pins H = Straight Pins G = Gull Wing | G = Gold | T = Std. Tube R = Tape and Reel |

▶ ▶ ▶ Example Ordering Number
KA-J-02-S-A-G-T

Specifications subject to change without notice.



SERIES KAJ SWITCHES

LOW-PROFILE DIP SWITCHES

TERMINATION & PIN SPACING OPTIONS

TACT SWITCHES

NAVIGATION SWITCHES

PUSHBUTTON SWITCHES

TOGGLE SWITCHES

ROCKER SWITCHES

SLIDE SWITCHES

SNAP-ACTION SWITCHES

DIP SWITCHES

KEYLOCK SWITCHES

ROTARY SWITCHES

DETECTOR SWITCHES

CAP OPTIONS

KAJ

STRAIGHT (FOR MANUAL INSERTION)

H 7.62mm SPACING

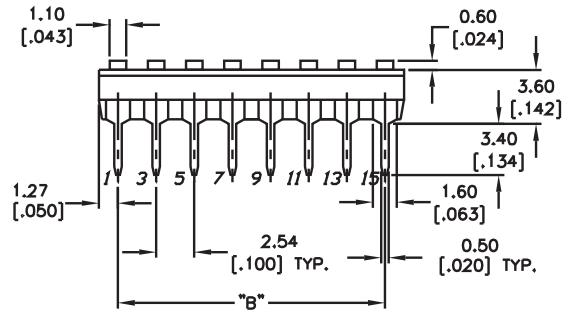
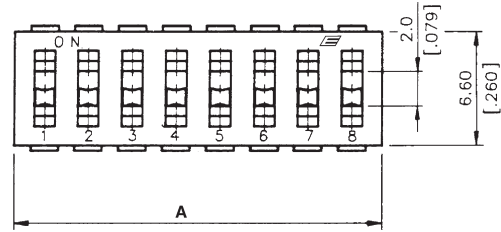
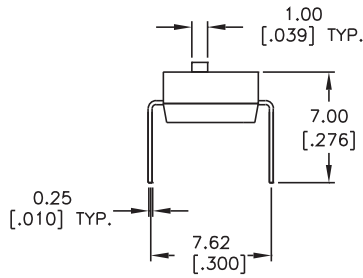

KAJ

SPLAY (FOR IC MACHINE INSERTION)

A 9.84mm SPACING

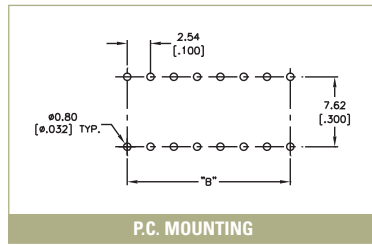
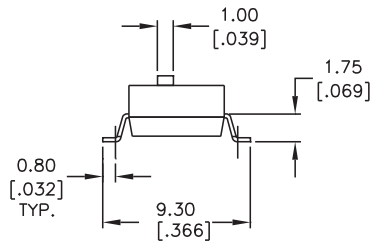
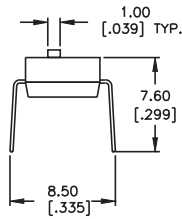

P.C. MOUNTING

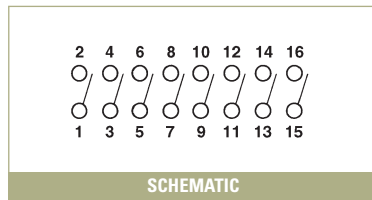

SCHEMATIC

KAJ

G GULL WING

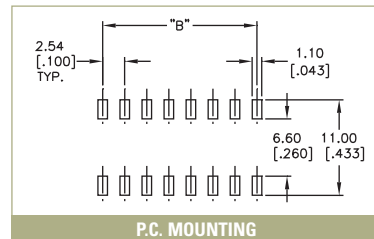
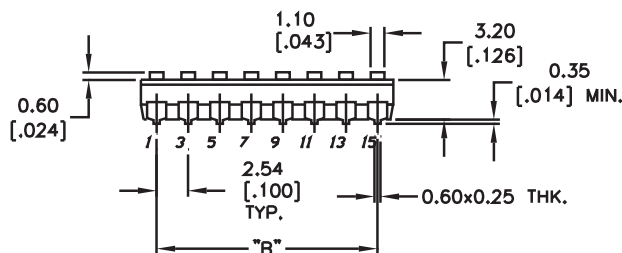
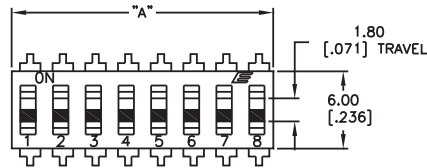

P.C. MOUNTING

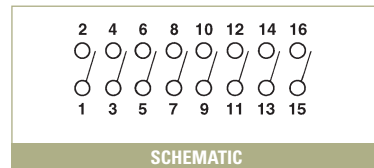

SCHEMATIC

ACTUATOR OPTIONS

S RECESSED

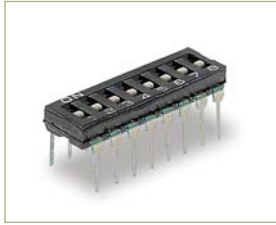

L EXTENDED

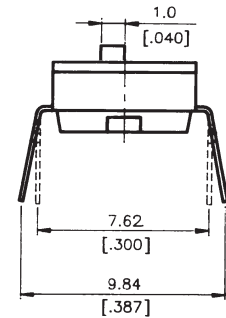
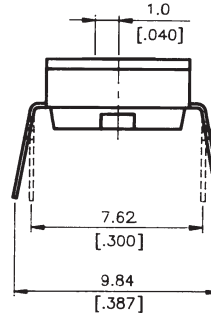
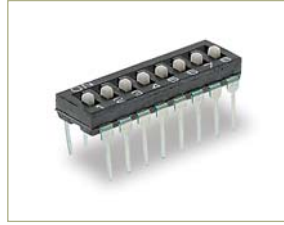

PACKAGING & SEAL OPTIONS

T TOP TAPE SEALED

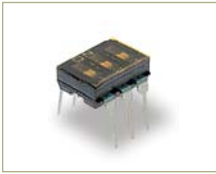

*Top Tape Seal for Recessed Actuator only.

R TAPE AND REEL WITH TOP TAPE SEAL

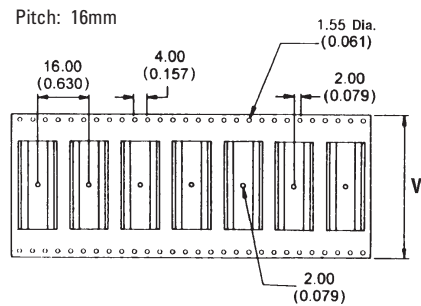

| Pos. | TapeSize (W) |
|------|--------------|
| 2 | 16mm |
| 3 | 16mm |
| 4 | 24mm |
| 5 | 24mm |
| 6 | 24mm |
| 7 | 32mm |
| 8 | 32mm |
| 9 | 44mm |
| 10 | 44mm |
| 12 | 44mm |

TACT SWITCHES

NAVIGATION SWITCHES

PUSHBUTTON SWITCHES

TOGGLE SWITCHES

ROCKER SWITCHES

SLIDE SWITCHES

SNAP-ACTION SWITCHES

DIP SWITCHES

KEYLOCK SWITCHES

ROTARY SWITCHES

DETECTOR SWITCHES

CAP OPTIONS