

**Features**

- Fast Switching Speed
- Surface Mount Package Ideally Suited for Automated Insertion
- For General Purpose Switching Applications
- High Conductance
- **Lead, Halogen and Antimony Free, RoHS Compliant “Green” Device (Notes 1 and 2)**
- **Qualified to AEC-Q101 Standards for High Reliability**

**Mechanical Data**

- Case: SOT23
- Case Material: Molded Plastic. UL Flammability Classification Rating 94V-0
- Moisture Sensitivity: Level 1 per J-STD-020
- Terminals: Solderable per MIL-STD-202, Method 208
- Lead Free Plating (Matte Tin Finish annealed over Alloy 42 leadframe).
- Polarity: See Diagram
- Weight: 0.008 grams (approximate)

SOT23



Top View

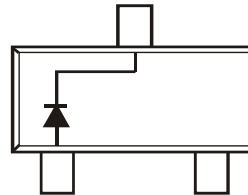

Top View  
Internal Schematic

**Ordering Information** (Note 3)

Part Number	Qualification	Case	Packaging
BAS19-7-F	Commercial	SOT23	3,000/Tape & Reel
BAS20-7-F	Commercial	SOT23	3,000/Tape & Reel
BAS20-13-F	Commercial	SOT23	10,000/Tape & Reel
BAS20Q-13-F	Automotive	SOT23	10,000/Tape & Reel
BAS21-7-F	Commercial	SOT23	3,000/Tape & Reel
BAS21Q-7-F	Automotive	SOT23	3,000/Tape & Reel
BAS21-13-F	Commercial	SOT23	10,000/Tape & Reel
BAS21Q-13-F	Automotive	SOT23	10,000/Tape & Reel

- Notes:
1. No purposefully added lead. Halogen and Antimony Free.
  2. Product manufactured with Data Code V9 (week 33, 2008) and newer are built with Green Molding Compound. Product manufactured prior to Date Code V9 are built with Non-Green Molding Compound and may contain Halogens or Sb<sub>2</sub>O<sub>3</sub> Fire Retardants.
  3. For packaging details, go to our website at <http://www.diodes.com>.

**Marking Information**

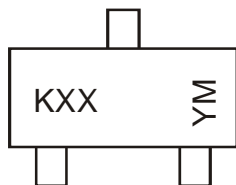

KXX = Product Type Marking Code  
 BAS19 Marking: KA8, KT3; KT2  
 BAS20 Marking: KT2, KT3  
 BAS21 Marking: KT3  
 YM = Date Code Marking  
 Y = Year (ex: Y = 2011)  
 M = Month (ex: 9 = September)

Date Code Key

Year	2000	2001	2002	.....	2009	2010	2011	2012	2013	2014	2015	2016	2017
Code	L	M	N	.....	W	X	Y	Z	A	B	C	D	E

Month	Jan	Feb	Mar	Apr	May	Jun	Jul	Aug	Sep	Oct	Nov	Dec
Code	1	2	3	4	5	6	7	8	9	O	N	D

**Maximum Ratings** @T<sub>A</sub> = 25°C unless otherwise specified

Characteristic	Symbol	BAS19	BAS20	BAS21	Unit		
Repetitive Peak Reverse Voltage	V <sub>RRM</sub>	120	200	250	V		
Working Peak Reverse Voltage DC Blocking Voltage	V <sub>RWM</sub> V <sub>R</sub>	100	150	200	V		
RMS Reverse Voltage	V <sub>R(RMS)</sub>	71	106	141	V		
Forward Continuous Current (Note 4)	I <sub>FM</sub>	400			mA		
Average Rectified Output Current (Note 4)	I <sub>O</sub>	200			mA		
Non-Repetitive Peak Forward Surge Current	I <sub>FSM</sub>				@ t = 1.0µs	2.5	A
					@ t = 1.0s	0.5	
Repetitive Peak Forward Surge Current (Note 4)	I <sub>FRM</sub>	625			mA		

**Thermal Characteristics**

Characteristic	Symbol	Value	Unit
Power Dissipation (Note 4)	P <sub>D</sub>	250	mW
Thermal Resistance Junction to Ambient Air (Note 4)	R <sub>θJA</sub>	500	°C/W
Operating and Storage Temperature Range	T <sub>J</sub> , T <sub>STG</sub>	-65 to +150	°C

**Electrical Characteristics** @T<sub>A</sub> = 25°C unless otherwise specified

Characteristic	Symbol	Min	Max	Unit	Test Condition
Reverse Breakdown Voltage (Note 5)	V <sub>(BR)R</sub>	BAS19 120	—	V	I <sub>R</sub> = 100µA
		BAS20 200			
		BAS21 250			
Forward Voltage	V <sub>F</sub>	—	1.0 1.25	V	I <sub>F</sub> = 100mA I <sub>F</sub> = 200mA
Reverse Current @ Rated DC Blocking Voltage (Note 5)	I <sub>R</sub>	—	100 15	nA µA	T <sub>J</sub> = 25°C T <sub>J</sub> = 100°C
Total Capacitance	C <sub>T</sub>	—	5.0	pF	V <sub>R</sub> = 0, f = 1.0MHz
Reverse Recovery Time	t <sub>rr</sub>	—	50	ns	I <sub>F</sub> = I <sub>R</sub> = 30mA, I <sub>rr</sub> = 0.1 x I <sub>R</sub> , R <sub>L</sub> = 100Ω

Notes: 4. Part mounted on FR-4 board with recommended pad layout, which can be found on our website at <http://www.diodes.com>.  
5. Short duration pulse test used to minimize self-heating effect.

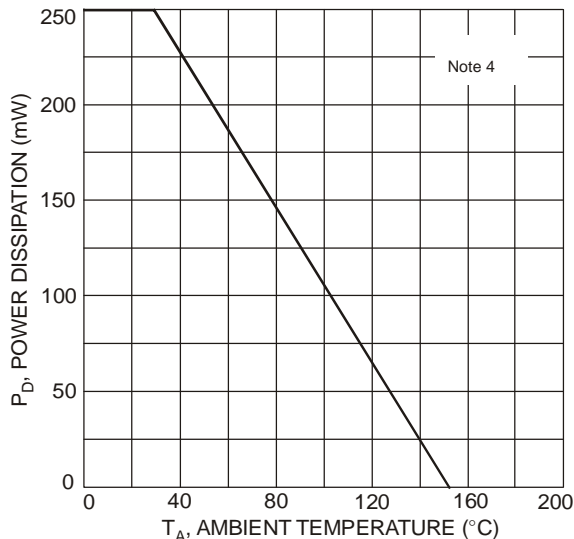

Fig. 1 Power Derating Curve

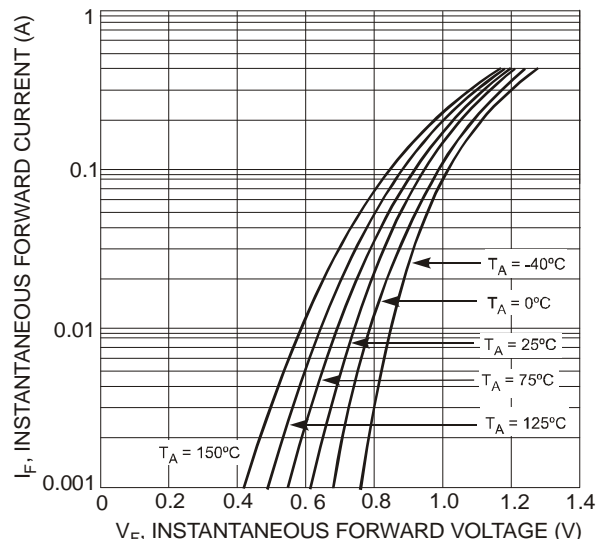

Fig. 2 Typical Forward Characteristics

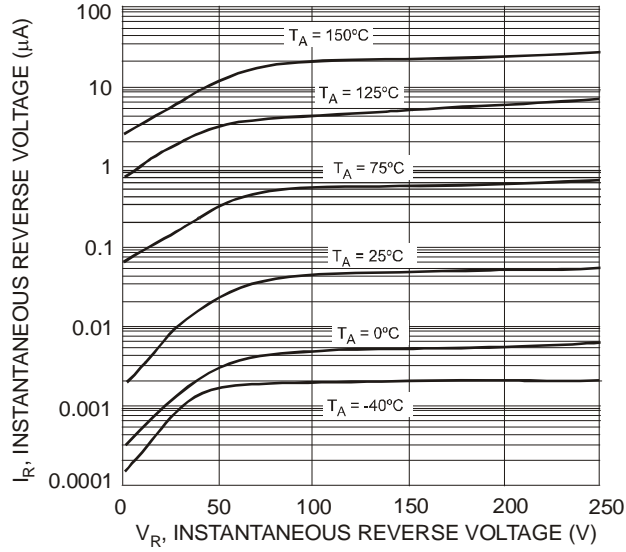

Fig. 3 Typical Reverse Characteristics

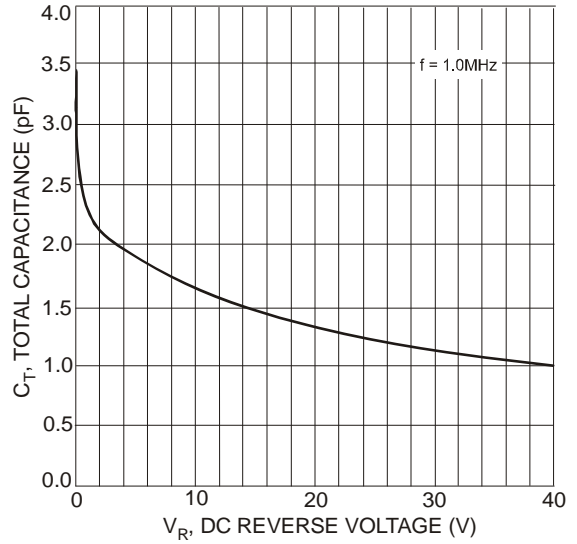
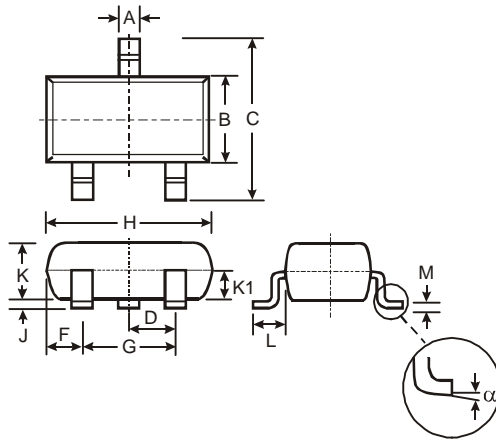

Fig. 4 Total Capacitance vs. Reverse Voltage

**Package Outline Dimensions**



SOT23			
Dim	Min	Max	Typ
A	0.37	0.51	0.40
B	1.20	1.40	1.30
C	2.30	2.50	2.40
D	0.89	1.03	0.915
F	0.45	0.60	0.535
G	1.78	2.05	1.83
H	2.80	3.00	2.90
J	0.013	0.10	0.05
K	0.903	1.10	1.00
K1	-	-	0.400
L	0.45	0.61	0.55
M	0.085	0.18	0.11
$\alpha$	0°	8°	-

All Dimensions in mm

**Suggested Pad Layout**

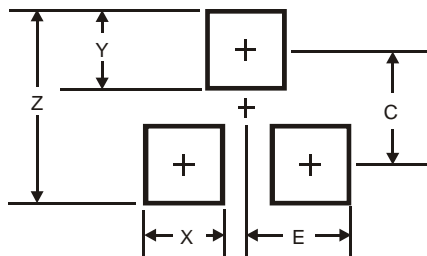

Dimensions	Value (in mm)
Z	2.9
X	0.8
Y	0.9
C	2.0
E	1.35

**IMPORTANT NOTICE**

DIODES INCORPORATED MAKES NO WARRANTY OF ANY KIND, EXPRESS OR IMPLIED, WITH REGARDS TO THIS DOCUMENT, INCLUDING, BUT NOT LIMITED TO, THE IMPLIED WARRANTIES OF MERCHANTABILITY AND FITNESS FOR A PARTICULAR PURPOSE (AND THEIR EQUIVALENTS UNDER THE LAWS OF ANY JURISDICTION).

Diodes Incorporated and its subsidiaries reserve the right to make modifications, enhancements, improvements, corrections or other changes without further notice to this document and any product described herein. Diodes Incorporated does not assume any liability arising out of the application or use of this document or any product described herein; neither does Diodes Incorporated convey any license under its patent or trademark rights, nor the rights of others. Any Customer or user of this document or products described herein in such applications shall assume all risks of such use and will agree to hold Diodes Incorporated and all the companies whose products are represented on Diodes Incorporated website, harmless against all damages.

Diodes Incorporated does not warrant or accept any liability whatsoever in respect of any products purchased through unauthorized sales channel. Should Customers purchase or use Diodes Incorporated products for any unintended or unauthorized application, Customers shall indemnify and hold Diodes Incorporated and its representatives harmless against all claims, damages, expenses, and attorney fees arising out of, directly or indirectly, any claim of personal injury or death associated with such unintended or unauthorized application.

Products described herein may be covered by one or more United States, international or foreign patents pending. Product names and markings noted herein may also be covered by one or more United States, international or foreign trademarks.

**LIFE SUPPORT**

Diodes Incorporated products are specifically not authorized for use as critical components in life support devices or systems without the express written approval of the Chief Executive Officer of Diodes Incorporated. As used herein:

A. Life support devices or systems are devices or systems which:

1. are intended to implant into the body, or
2. support or sustain life and whose failure to perform when properly used in accordance with instructions for use provided in the labeling can be reasonably expected to result in significant injury to the user.

B. A critical component is any component in a life support device or system whose failure to perform can be reasonably expected to cause the failure of the life support device or to affect its safety or effectiveness.

Customers represent that they have all necessary expertise in the safety and regulatory ramifications of their life support devices or systems, and acknowledge and agree that they are solely responsible for all legal, regulatory and safety-related requirements concerning their products and any use of Diodes Incorporated products in such safety-critical, life support devices or systems, notwithstanding any devices- or systems-related information or support that may be provided by Diodes Incorporated. Further, Customers must fully indemnify Diodes Incorporated and its representatives against any damages arising out of the use of Diodes Incorporated products in such safety-critical, life support devices or systems.

Copyright © 2011, Diodes Incorporated

[www.diodes.com](http://www.diodes.com)