

## SIPMOS® Small-Signal Transistor

**BSS 129**

- $V_{DS}$  240 V
- $I_D$  0.15 A
- $R_{DS(on)}$  20  $\Omega$
- N channel
- Depletion mode
- High dynamic resistance
- Available grouped in  $V_{GS(th)}$

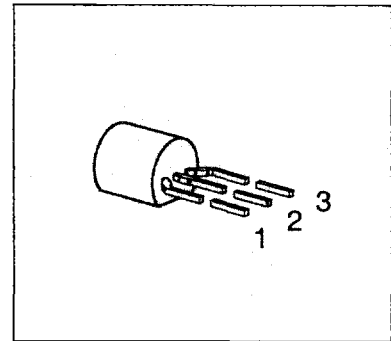

Type	Ordering Code	Tape and Reel Information	Pin Configuration			Marking	Package
			1	2	3		
BSS 129	Q62702-S015	E6288: 1500 pcs/reel; 2 reels/carton; gate first	G	D	S	SS 129	TO-92
BSS 129	Q67000-S116	E6296: 1500 pcs/reel; 2 reels/carton; source first					

### Maximum Ratings

Parameter	Symbol	Values	Unit
Drain-source voltage	$V_{DS}$	240	V
Drain-gate voltage, $R_{GS} = 20 \text{ k}\Omega$	$V_{DGR}$	240	
Gate-source voltage	$V_{GS}$	$\pm 14$	
Gate-source peak voltage, aperiodic	$V_{gs}$	$\pm 20$	
Continuous drain current, $T_A = 37 \text{ }^\circ\text{C}$	$I_D$	0.15	A
Pulsed drain current, $T_A = 25 \text{ }^\circ\text{C}$	$I_{D \text{ puls}}$	0.45	
Max. power dissipation, $T_A = 25 \text{ }^\circ\text{C}$	$P_{tot}$	1.0	W
Operating and storage temperature range	$T_j, T_{stg}$	- 55 ... + 150	$^\circ\text{C}$
Thermal resistance, chip-ambient (without heat sink)	$R_{thJA}$	$\leq 125$	K/W
DIN humidity category, DIN 40 040	-	E	-
IEC climatic category, DIN IEC 68-1	-	55/150/56	-

## Electrical Characteristics

at  $T_j = 25\text{ }^\circ\text{C}$ , unless otherwise specified.

Parameter	Symbol	Values			Unit
		min.	typ.	max.	

## Static Characteristics

Drain-source breakdown voltage $V_{GS} = -3\text{ V}, I_D = 0.25\text{ mA}$	$V_{(BR)DSS}$	240	–	–	V
Gate threshold voltage $V_{DS} = 3\text{ V}, I_D = 1\text{ mA}$	$V_{GS(th)}$	– 1.8	– 1.2	– 0.7	
Drain-source cutoff current $V_{DS} = 240\text{ V}, V_{GS} = -3\text{ V}$ $T_j = 25\text{ }^\circ\text{C}$ $T_j = 125\text{ }^\circ\text{C}$	$I_{DSS}$	–	–	100 200	nA $\mu\text{A}$
Gate-source leakage current $V_{GS} = 20\text{ V}, V_{DS} = 0$	$I_{GSS}$	–	10	100	nA
Drain-source on-resistance $V_{GS} = 0\text{ V}, I_D = 0.014\text{ A}$	$R_{DS(on)}$	–	7.0	20	$\Omega$

## Dynamic Characteristics

Forward transconductance $V_{DS} \geq 2 \times I_D \times R_{DS(on)max}, I_D = 0.25\text{ A}$	$g_{fs}$	0.14	0.2	–	S
Input capacitance $V_{GS} = 0, V_{DS} = 25\text{ V}, f = 1\text{ MHz}$	$C_{iss}$	–	110	150	$\mu\text{F}$
Output capacitance $V_{GS} = 0, V_{DS} = 25\text{ V}, f = 1\text{ MHz}$	$C_{oss}$	–	20	30	
Reverse transfer capacitance $V_{GS} = 0, V_{DS} = 25\text{ V}, f = 1\text{ MHz}$	$C_{rss}$	–	7	10	
Turn-on time $t_{on}$ , ( $t_{on} = t_{d(on)} + t_r$ ) $V_{DD} = 30\text{ V}, V_{GS} = -2\text{ V} \dots +5\text{ V}, R_{GS} = 50\text{ }\Omega,$ $I_D = 0.25\text{ A}$	$t_{d(on)}$	–	4	6	ns
	$t_r$	–	10	15	
Turn-off time $t_{off}$ , ( $t_{off} = t_{d(off)} + t_f$ ) $V_{DD} = 30\text{ V}, V_{GS} = -2\text{ V} \dots +5\text{ V}, R_{GS} = 50\text{ }\Omega,$ $I_D = 0.25\text{ A}$	$t_{d(off)}$	–	15	20	
	$t_f$	–	25	35	

**Electrical Characteristics (cont'd)**

at  $T_i = 25\text{ °C}$ , unless otherwise specified.

Parameter	Symbol	Values			Unit
		min.	typ.	max.	

**Reverse Diode**

Continuous reverse drain current $T_A = 25\text{ °C}$	$I_S$	–	–	0.15	A
Pulsed reverse drain current $T_A = 25\text{ °C}$	$I_{SM}$	–	–	0.45	
Diode forward on-voltage $I_F = 0.3\text{ A}, V_{GS} = 0$	$V_{SD}$	–	0.7	1.4	V

$V_{GS(th)}$ Grouping	Symbol	Limit Values		Unit	Test Condition
		min.	max.		
Range of $V_{GS(th)}$	$\Delta V_{GS(th)}$	–	0.2	V	–
Threshold Voltage selected in groups <sup>1)</sup> :	$V_{GS(th)}$				$V_{DS1} = 0.2\text{ V};$ $V_{DS2} = 3\text{ V};$ $I_D = 10\text{ }\mu\text{A}$
F		– 1.600	– 1.400	V	
G		– 1.700	– 1.500	V	
A		– 1.800	– 1.600	V	
B		– 1.900	– 1.700	V	
C		– 2.000	– 1.800	V	
D		– 2.100	– 1.900	V	

1) A specific group cannot be ordered separately.  
Each reel only contains transistors from one group.

**Characteristics**

at  $T_j = 25^\circ\text{C}$ , unless otherwise specified.

**Total power dissipation  $P_{\text{tot}} = f(T_A)$**

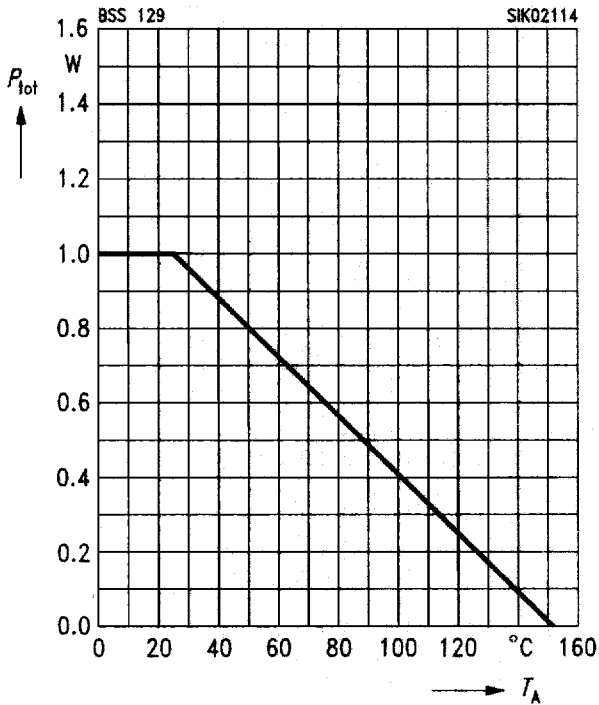

**Safe operating area  $I_D = f(V_{DS})$**

parameter:  $D = 0.01, T_C = 25^\circ\text{C}$

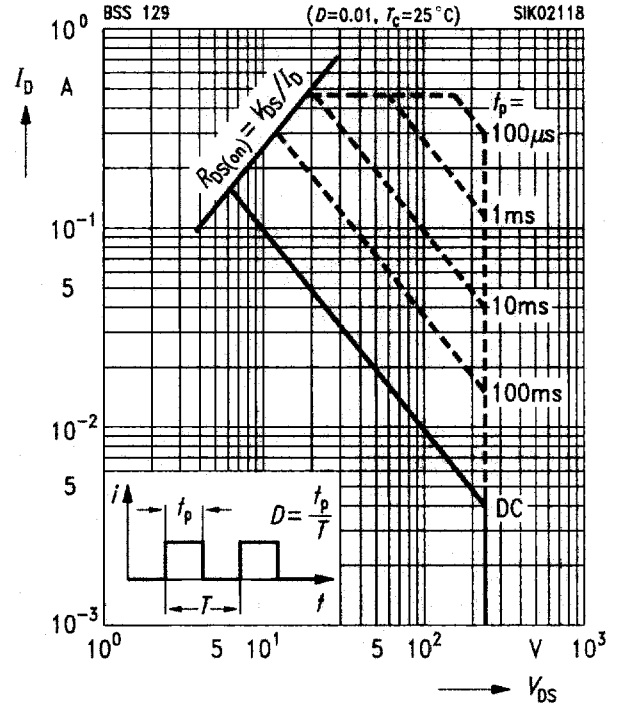

**Typ. output characteristics  $I_D = f(V_{DS})$**

parameter:  $t_p = 80 \mu\text{s}$

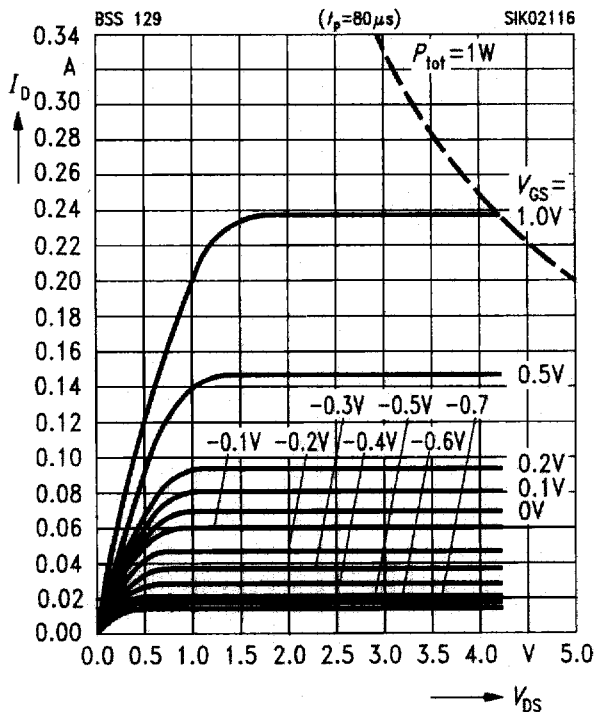

**Typ. drain-source on-resistance**

$R_{DS(on)} = f(I_D)$

parameter:  $V_{GS}$

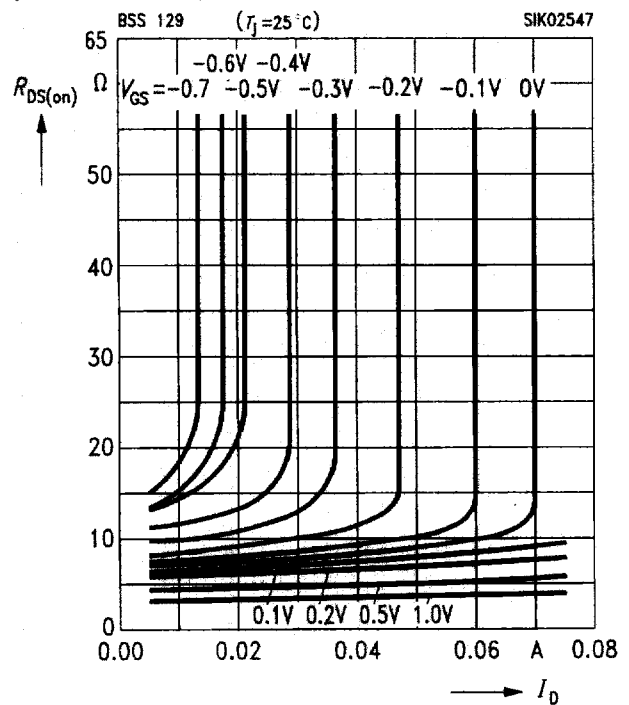

**Typ. transfer characteristics  $I_D = f(V_{GS})$**

parameter:  $t_p = 80 \mu s, V_{DS} \geq 2 \times I_D \times R_{DS(on)max.}$

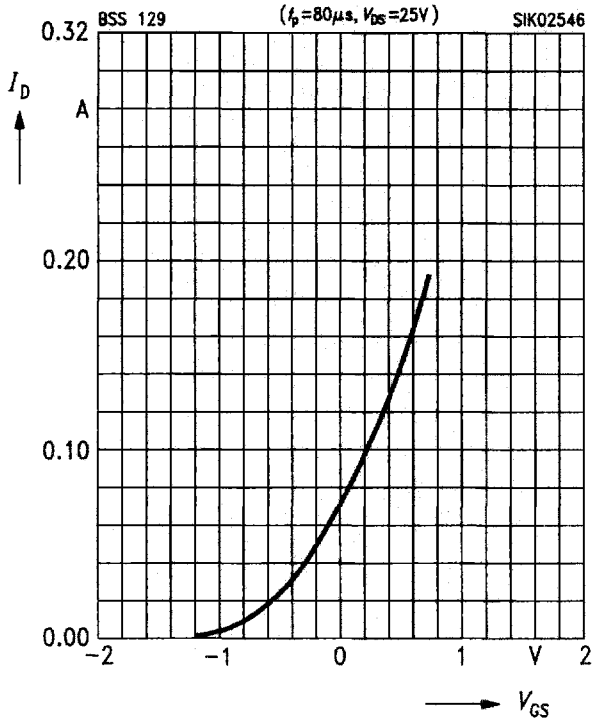

**Typ. forward transconductance  $g_{fs} = f(I_D)$**

parameter:  $V_{DS} \geq 2 \times I_D \times R_{DS(on)max.}, t_p = 80 \mu s$

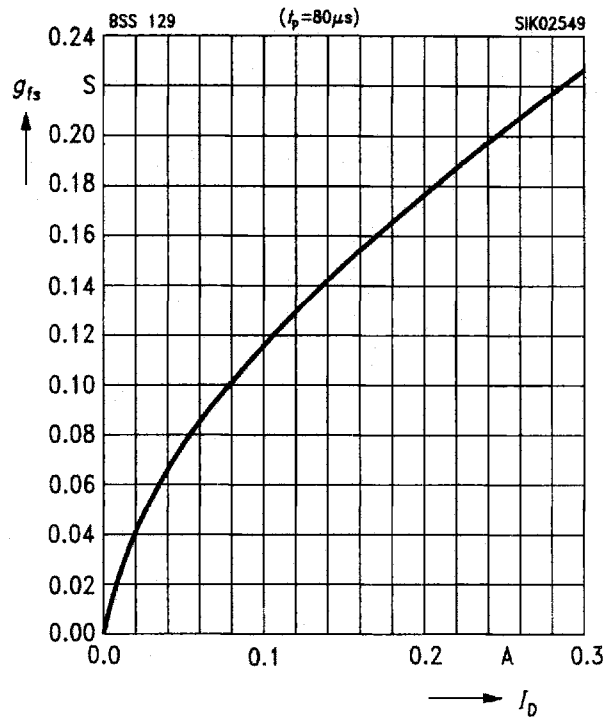

**Drain-source on-resistance**

$R_{DS(on)} = f(T_j)$

parameter:  $I_D = 0.014 A, V_{GS} = 0 V, (spread)$

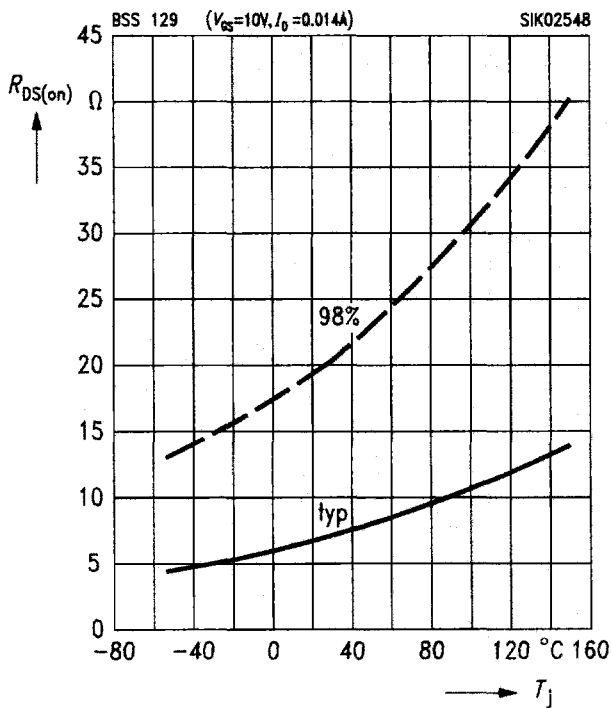

**Typ. capacitances  $C = f(V_{DS})$**

parameter:  $V_{GS} = 0, f = 1 MHz$

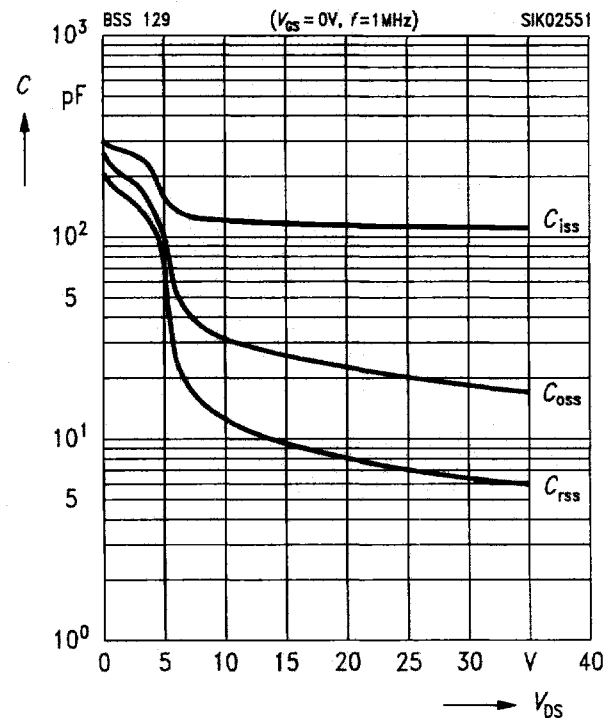

**Gate threshold voltage**  $V_{GS(th)} = f(T_j)$   
 parameter:  $V_{DS} = 3\text{ V}$ ,  $I_D = 1\text{ mA}$ , (spread)

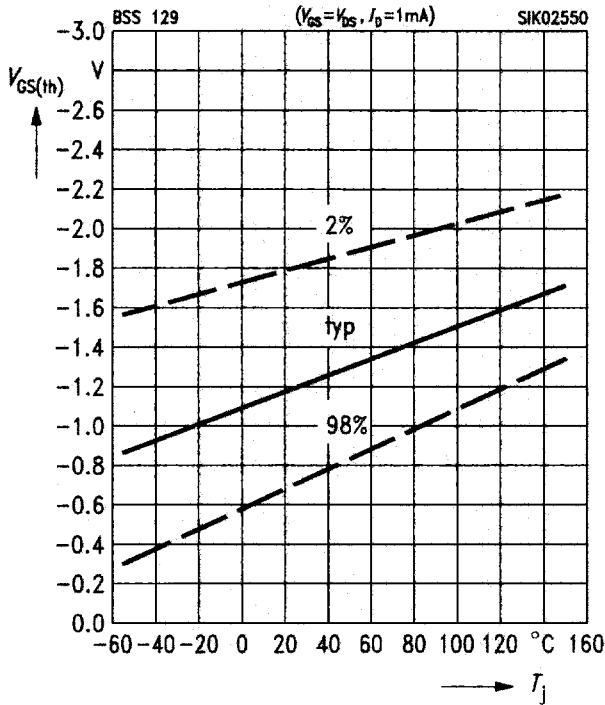

**Forward characteristics of reverse diode**  
 $I_F = f(V_{SD})$   
 parameter:  $t_p = 80\ \mu\text{s}$ ,  $T_j$ , (spread)

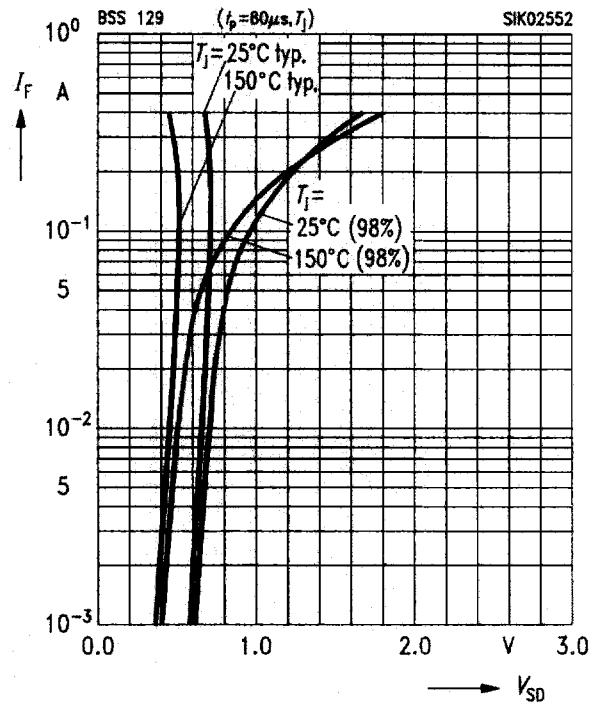

**Drain current**  $I_D = f(T_A)$   
 parameter:  $V_{GS} \geq 3\text{ V}$

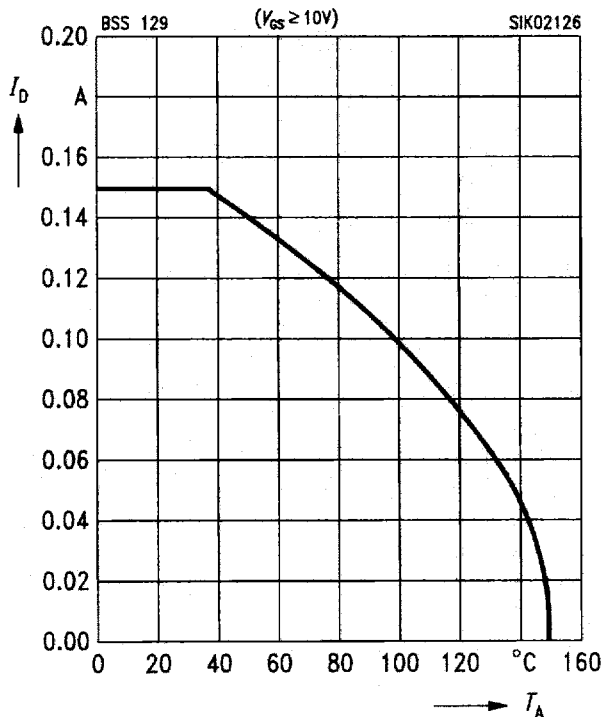

**Drain-source breakdown voltage**  
 $V_{(BR)DSS} = b \times V_{(BR)DSS}(25\text{ °C})$

