

PLEASE CHECK WWW.MOLEX.COM FOR LATEST PART INFORMATION

Part Number: [0477251310](#)
Status: **Active**
Overview: [mx150](#)
Description: MX150™ Male 2x6 Panel Mount Connector, Key Option A, Black

Documents:

[Drawing \(PDF\)](#) [RoHS Certificate of Compliance \(PDF\)](#)

General

Product Family	Crimp Housings
Series	47725
Overview	mx150
Product Name	MX150™

Physical

Circuits (maximum)	12
Circuits Detail	12
Color - Resin	Black
Gender	Male
Glow-Wire Compliant	No
Keying to Mating Part	Yes
Lock to Mating Part	Yes
Number of Rows	2
Packaging Type	Bag
Panel Mount	Yes
Pitch - Mating Interface (in)	0.138 In
Pitch - Mating Interface (mm)	3.50 mm
Pitch - Term. Interface (in)	0.138 In
Pitch - Term. Interface (mm)	3.50 mm
Polarized to Mating Part	Yes
Temperature Range - Operating	-40°C to +125°C

Electrical

Current - Maximum per Contact	22A
-------------------------------	-----

Material Info

Reference - Drawing Numbers

Packaging Specification	PK-47725-001
Sales Drawing	SD-47725-130



EU RoHS

**ELV and RoHS
Compliant**
REACH SVHC
 Not Reviewed
**Halogen-Free
Status**
 Not Reviewed

China RoHS



**Need more information on product
environmental compliance?**

Email productcompliance@molex.com
 For a multiple part number RoHS Certificate of
 Compliance, [click here](#)

Please visit the [Contact Us](#) section for any
 non-product compliance questions.

Search Parts in this Series

[47725Series](#)

Mates With

[33472 MX150™ Sealed Female Connector](#)

PLEASE CHECK WWW.MOLEX.COM FOR LATEST PART INFORMATION

TRACEABILITY INFORMATION
LOCATION IN THIS AREA

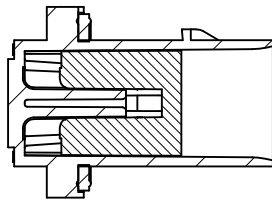
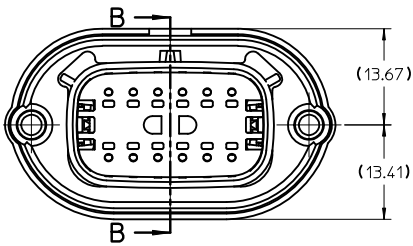
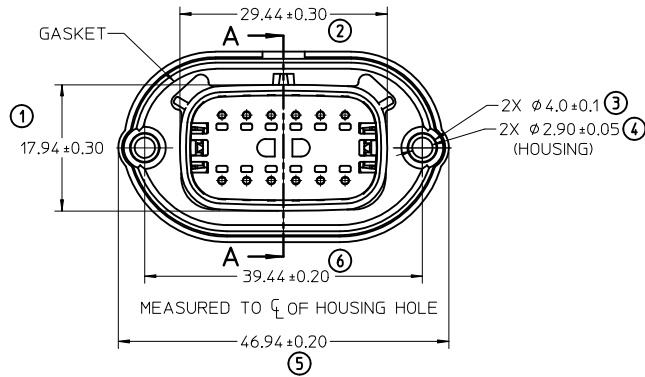
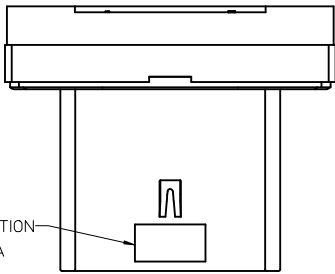

SECTION A-A
(TPA SHOWN IN PRE-LOCK POSITION)
SEE NOTE 3

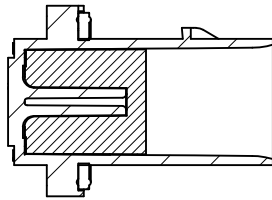

SECTION B-B
(TPA SHOWN IN FULL-LOCK POSITION)
FOR REFERENCE ONLY

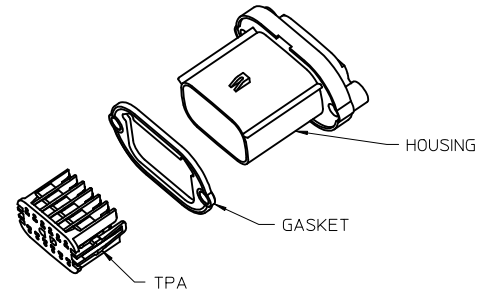
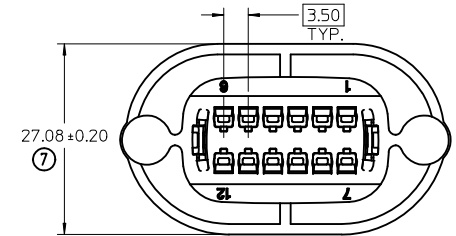
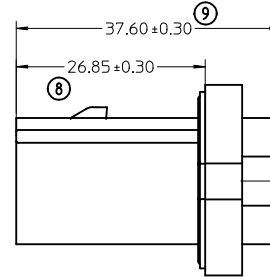

ASSY. P/N	KEY OPTION	DESCRIPTION	COLOR
477251310	A	HOUSING	BLACK
		GASKET	GRAY
		TPA	NATURAL
477251330	C	HOUSING	DARK GRAY
		GASKET	GRAY
		TPA	NATURAL
477251340	D	HOUSING	STONE GRAY
		GASKET	GRAY
		TPA	NATURAL

ENTER DESCRIPTION IEC NO: GCA2010-0081 DRWN: CDZHANG 2010/03/31 CHKD: LOMMAN 2009/05/18 APPR: GGLEE 2010/04/01 REV	QUALITY SYMBOLS 	GENERAL TOLERANCES (UNLESS SPECIFIED)		DIMENSION STYLE MM ONLY		SCALE 2:1	DESIGN UNITS METRIC	THIRD ANGLE PROJECTION			
		4 PLACES ± --- ± --- 3 PLACES ± --- ± --- 2 PLACES ± --- ± --- 1 PLACE ± 0.1 ± ---	mm INCH	DRAWN BY CDZHANG	DATE 2009/05/18	TITLE GENERAL MX150 2X6 PANEL MOUNT CONNECTOR					
		ANGULAR ± 3 °		CHECKED BY SPCAO	DATE 2009/05/18						
		DRAFT WHERE APPLICABLE MUST REMAIN WITHIN DIMENSIONS		SEE CHART		APPROVED BY GGLEE		DATE 2010/03/31	MOLEX INCORPORATED		
		MATERIAL NO. SEE CHART		DOCUMENT NO. SD-47725-130		SHEET NO. 1 OF 1		THIS DRAWING CONTAINS INFORMATION THAT IS PROPRIETARY TO MOLEX INCORPORATED AND SHOULD NOT BE USED WITHOUT WRITTEN PERMISSION			

- NOTES: UNLESS OTHERWISE SPECIFIED.
- SHALL CONFORM TO MOLEX PRODUCT SPECIFICATION: PS-47725-000
 - USAGE OF THE PRODUCT SHALL BE IN COMPLIANCE TO MOLEX APPLICATION SPECIFICATION: AS-47725-001
 - SHIPPED WITH GASKET AND TPA IN PRE-LOCK POSITION
 - FOR ESSENTIAL PARTS (TERMINALS, WIRES ETC.) AND INSTALLATION TO COMPLETE ASSEMBLY SEE MOLEX PRODUCT SPECIFICATION: PS-33472-000.
 - FOR TERMINAL SERVICING TOOL SEE MOLEX DOCUMENT: ATS-638131500, GM PART NUMBER J-38125-217
 - DESIGNED TO MATE WITH 12 WAY RECEPTACLE CONNECTOR ASSEMBLY PER SD-33472-121. FOR MATING CONNECTOR ASSEMBLY INFORMATION SEE MOLEX PRODUCT SPECIFICATION: PS-33472-000