

Antena Plug

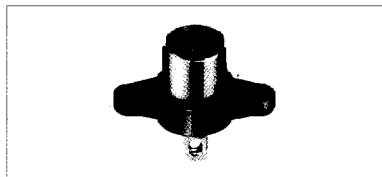

TCP9105

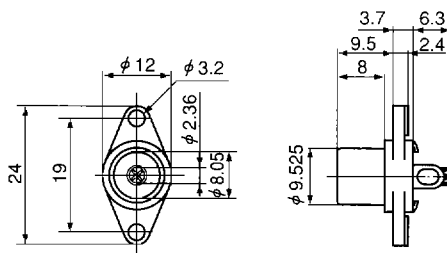

Antena Plug



TCP9106

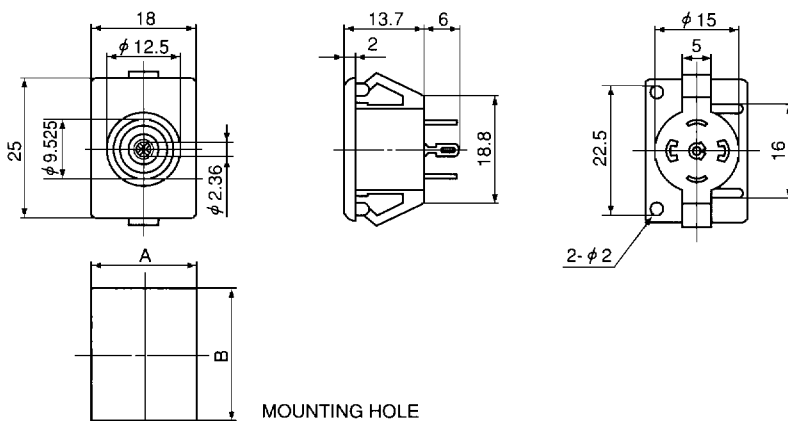

寸法 Dimensions	厚さ Thickness	t=1	t=2
A		16.3	16.3
B		22.6	23.2

Antena Plug

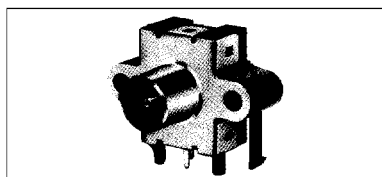

TCP9110

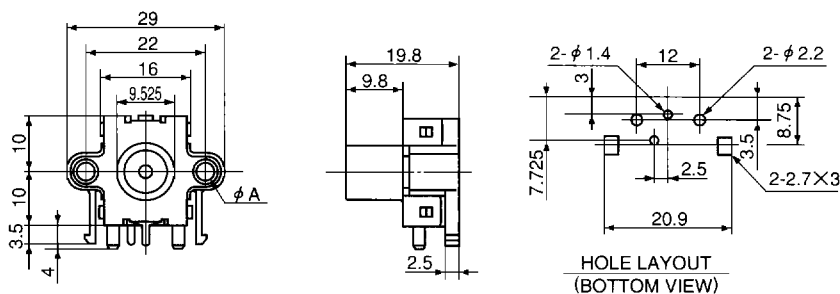

φ A	品番 / Model No.
3.2	TCP9110-11-1111
2.6	TCP9110-11-1011

Antena Socket

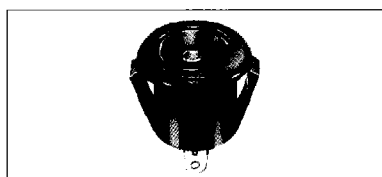

TCS9105

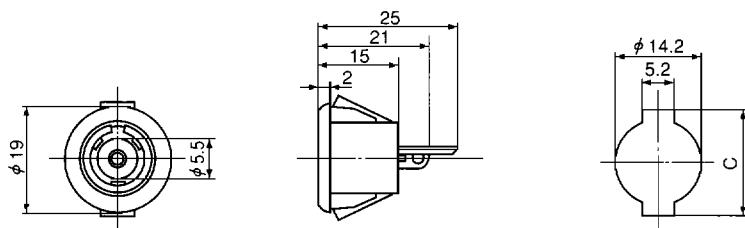

品番 / Model No.	Board Thickness	Dimension C
TCS9105-01-102	2	18
TCS9105-01-101	1.1	17.5

MOUNTING HOLE
 (BOARD THICKNESS 1.1or2)