

### KB827-B

#### GENERAL PURPOSE HIGH ISOLATION VOLTAGE SINGLE TRANSISTOR TYPE PHOTOCOUPLER SERIES

#### FEATURES

1. Lead forming (gull wing) type, for surface mounting.
2. High isolation voltage between input and output (Viso=5000 Vrms).
3. Compact dual-in-line package  
KB827-B: 2-channel type.
4. Recognized by UL and CUL, file NO.E225308.
5. Approved by VDE 0884 Teil2(NO:40006364)  
(Creepage distance between input and output:7mm or more).
6. Rohs compliant.

#### DESCRIPTION

1. The KB827-B (2-channel) is optically coupled isolators containing a GaAs light emitting diode and an NPN silicon phototransistor.
2. The lead pitch is 2.54mm.
3. Solid insulation thickness between emitting diode and output phototransistor:  $\geq 0.6$ mm.

#### APPLICATIONS

1. Computer terminals.
2. Registers, copiers, automatic vending machines.
3. System appliances, measuring instruments.
4. Programmable logic controller.
5. Signal transmission between circuits of different potentials and impedances.

### KB827-B

#### \*PACKAGE DIMENSIONS (UNIT:mm)

##### Lead Bending Type

TOLERANCE :  $\pm 0.5[\pm 0.02]$  UNLESS OTHERWISE NOTED.

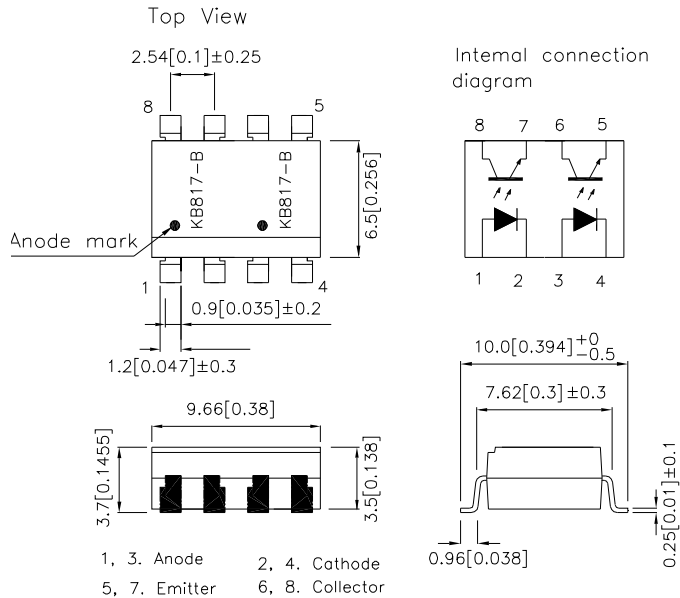

#### \*Absolute Maximum Ratings (Ta=25°C)

Parameter		Symbol	Rating	Unit
Input	Forward current	$I_F$	50	mA
	Reverse voltage	$V_R$	6	V
	Power dissipation	$P$	70	mW
Output	Collector-emitter voltage	$V_{CEO}$	35	V
	Emitter-collector voltage	$V_{ECO}$	6	V
	Collector current	$I_C$	50	mA
	Collector power dissipation	$P_C$	150	mW
Total power dissipation		$P_{tot}$	200	mW
*1 Isolation voltage		$V_{iso}$	5000	Vrms
Operating temperature		$T_{opr}$	-30~+100	°C
Storage temperature		$T_{stg}$	-55~+125	°C
*2 Soldering temperature		$T_{sol}$	260	°C

\*1 40 to 60% RH, AC for 1 minute.

\*2 For 10 seconds.

### KB827-B

#### \*Electro-optical Characteristics

Parameter		Symbol	Conditions	Min.	Typ.	Max.	Unit
Input	Forward voltage	$V_F$	$I_F=20mA$	---	1.2	1.4	V
	Peak forward voltage	$V_{FM}$	$I_{FM}=0.5A$	---	---	3.0	V
	Reverse current	$I_R$	$V_R=4V$	---	---	10	$\mu A$
Output	Collector dark current	$I_{CEO}$	$V_{CE}=20V, I_F=0mA$	---	---	$10^{-7}$	A
Transfer characteristics	*1Current transfer ratio	CTR	$I_F=5mA, V_{CE}=5V$	50	---	600	%
	Collector-emitter saturation voltage	$V_{CE(sat)}$	$I_F=20mA, I_C=1mA$	---	0.1	0.2	V
	Cut-off frequency	$f_c$	$V_{CE}=5V, I_C=2mA$ $R_L=100\Omega, -3dB$	---	80	---	KHz
	Response time	Rise time	$t_r$	$V_{CE}=2V, I_C=2mA$ $R_L=100\Omega$	---	4	18
Fall time		$t_f$	---		3	18	$\mu s$

\*1 Classification table of current transfer ratio is shown below.

$$CTR = \frac{I_C}{I_F} \times 100\%$$

Model No.	Rank mark	CTR(%)
KB827L-B	L	50 to 100
KB827A-B	A	80 to 160
KB827B-B	B	130 to 260
KB827C-B	C	200 to 400
KB827D-B	D	300 to 600
KB827AB-B	A or B	80 to 260
KB827BC-B	B or C	130 to 400
KB827CD-B	C or D	200 to 600
KB827AC-B	A,B or C	80 to 400
KB827BD-B	B,C or D	130 to 600
KB827AD-B	A,B,C or D	80 to 600
KB827-B	L,A,B,C,D or No mark	50 to 600

Fig. 1 Current Transfer Ratio vs. Forward Current

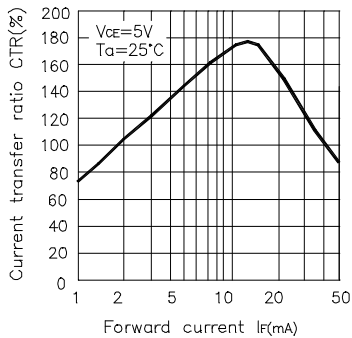

Fig. 2 Forward Current vs. Forward Voltage

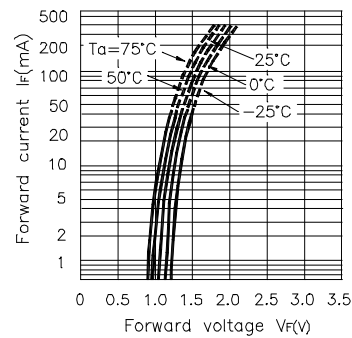

Fig. 3 Collector Current vs. Collector-emitter Voltage

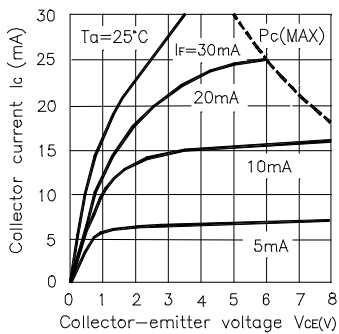

Fig. 4 Relative Current Transfer Ratio vs. Ambient Temperature

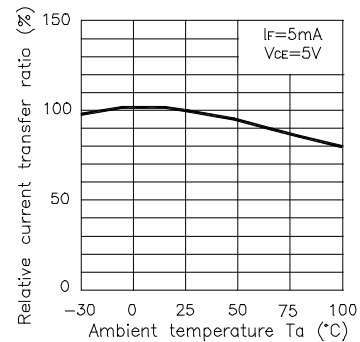

Fig. 5 Collector-emitter Saturation Voltage vs. Ambient Temperature

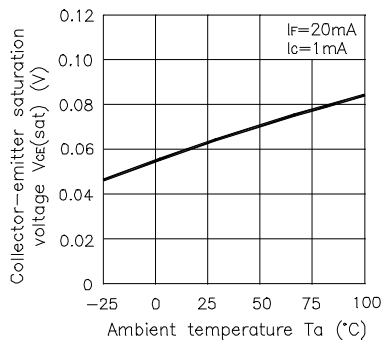
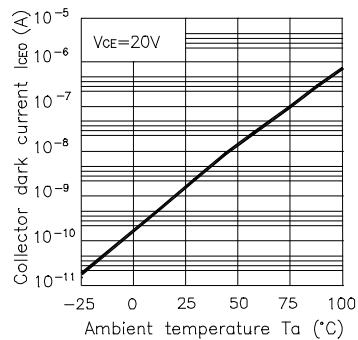
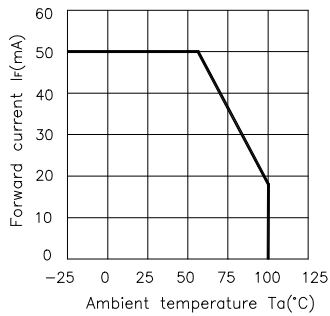

Fig. 6 Collector Dark Current vs. Ambient Temperature



**Fig. 7 Forward Current vs. Ambient Temperature**



**Fig. 8 Collector Power Dissipation vs. Ambient Temperature**

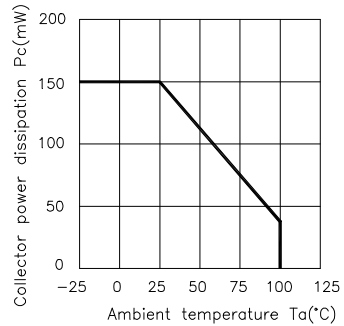

**Fig. 9 Response Time vs. Load Resistance**

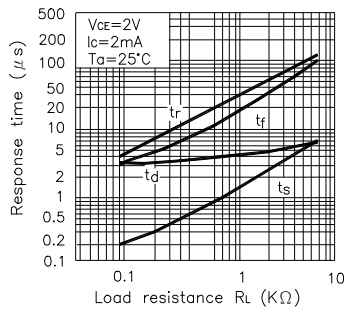

**Test Circuit for Response Time**

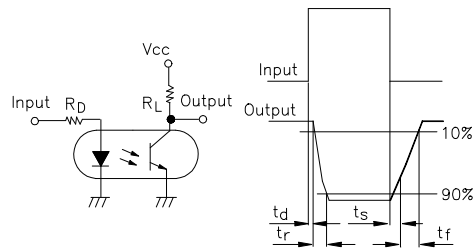

**Fig. 10 Frequency Response**

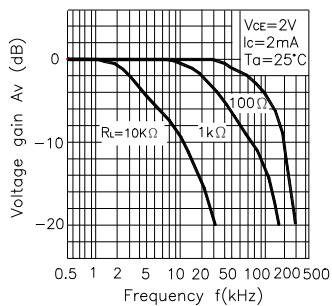

**Test Circuit for Frequency Response**

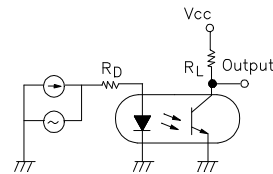
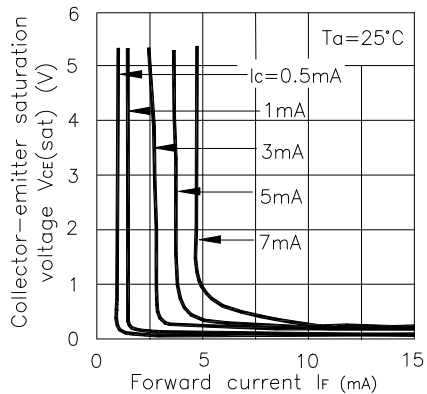

Fig. 11 Collector-emitter Saturation Voltage vs. Forward Current



### \*NOTES ON HANDLING

#### 1.Recommended soldering conditions (Dip soldering)

##### (1) Dip soldering

Temperature	260°C or below (molten solder temperature)
Time	Less than 10 seconds.
Cycle	One cycle allowed to be dipped in solder including plastic mold portion.
Flux	Rosin flux containing small amount of chorine (The flux with a maximum chlorine content of 0.2 Wt % is recommended.)

##### (2) Cautions

Fluxes  
Aavoid removing the residual flux with freon-based and chlorine-based cleaning solvent.

#### 2.Cautions regarding noise

Be aware that power is suddenly into the componment any surge current may cause damage happen, even if the voltage is within the absolute maximum ratings.

#### NOTES ON HANDLING

##### 1. Recommended soldering conditions

###### (1). Infrared reflow soldering

- |   |   |
|---|---|
| ● Peak reflow temperature               | 235°C or below (package surface temperature)  |
| ● Time of temperature higher than 210°C | 30 seconds or less  |
| ● Number of reflows                     | Three   |
| ● Flux                                  | Rosin flux containing small amount of chlorine (The flux with a maximum chlorine content of 0.2Wt% is recommended.) |

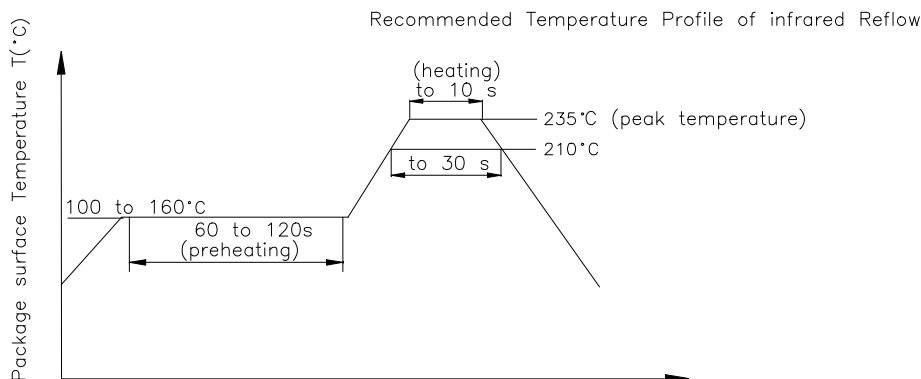

#### CAUTION

Within this device there exists GaAs (Gallium Arsenide) material which is a harmful substance if ingested.

GaAs dust and fumes are toxic. Do not break, cut or pulverize the product, or use chemicals to dissolve them.

#### RESTRICTIONS ON PRODUCT USE

- The information in this document is subject to change without notice. Before using this document, please confirm that this is the latest version. Not all devices / types available in every country.
- We mention about our product quality stability, semiconductor devices in general can malfunction or fail due to their inherent electrical sensitivity and vulnerability to physical stress. It is the responsibility of the buyer, when utilizing KINGBRIGHT products, to observe standards of safety, and to avoid situations in which a malfunction or failure of a KINGBRIGHT product could cause loss of human life, bodily injury or damage to property. In developing your designs, please ensure that KINGBRIGHT products are used within specified operating ranges as set forth in the most recent products specifications.

### KB827-B

Dimension of Tube

TOLERANCE :  $\pm 0.4[\pm 0.012]$  UNLESS OTHERWISE NOTED.  
Unit:mm

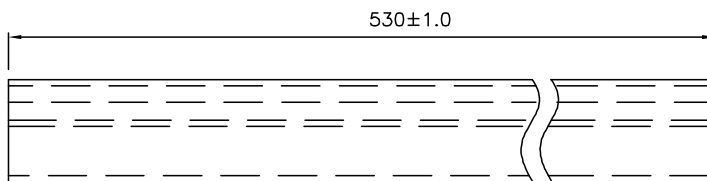
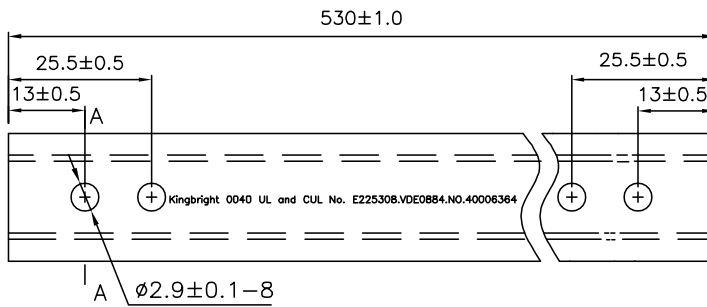

A-A Side view

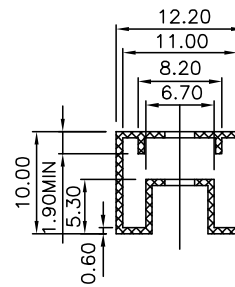

Dimension of Carton

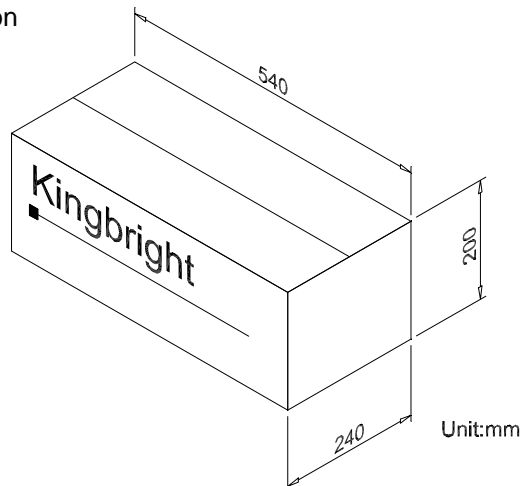

Part Number	Package	Packing Style
KB827-B	8-pin DIP	50pcs / each tube