







Industry Standard Power MOSFETS

All devices are available screened to TX, TXV, or S Level equivalent. Reference the High-Reliability Screening table for details. Contact your local Representative or STC for additional package configurations and special testing.

Package	Part Number	BV _{DSS}	I _D	R _{DS(ON)}	Die	
N-Channel TO-3 	2N6756	100	14	0.18	IRFC130	
	2N6758	200	9	0.40	IRFC230	
	2N6760	400	5.5	1.0	IRFC330	
	2N6762	500	4.5	1.50	IRFC430	
	2N6768	400	14	0.30	IRFC350	
	2N6770	500	12	0.40	IRFC450	
	TO-3/.060 pins 	2N6764	100	38	0.055	IRFC150
		2N6766	200	30	.085	IRFC250
	TO-39 	2N6782	100	3.5	0.60	IRFC110
		2N6784	200	2.25	1.50	IRFC210
		2N6786	400	1.25	3.60	IRFC310
		2N6788	100	6	0.30	IRFC120
		2N6790	200	3.5	0.80	IRFC220
2N6792		400	2.0	1.80	IRFC320	
2N6794		500	1.5	3.0	IRFC420	
2N6796		100	8.0	0.18	IRFC130	
2N6798		200	5.5	0.40	IRFC230	
2N6800		400	3.0	1.0	IRFC330	
2N6802		500	2.5	1.5	IRFC430	
TO-254 		2N7218	100	28.0	0.077	IRFC140
		2N7219	200	18.0	0.18	IRFC240
	2N7221	400	10.0	0.55	IRFC340	
	2N7222	500	8.0	0.85	IRFC440	
	2N7224	100	34.0	0.07	IRFC150	
	2N7225	200	27.4	0.10	IRFC250	
	2N7227	400	14.0	0.315	IRFC350	
	2N7228	500	12.0	0.415	IRFC450	
	P-Channel TO-3 	2N6804	-100	-12	0.30	IRFC9130
2N6806		-200	-6.5	0.80	IRFC9230	
TO-39 		2N6845	-100	-4.0	1.2	IRFC9120
	2N6847	-200	-2.5	1.5	IRFC9220	
	2N6849	-100	-6.5	0.30	IRFC9130	
	2N6851	-200	-4.0	0.80	IRFC9230	
TO-254 	2N7236	-100	-18.0	0.20	IRFC9140	
	2N7237	-200	-11.0	0.51	IRFC9240	

Part Number Ordering Information

STC QML Part Numbers

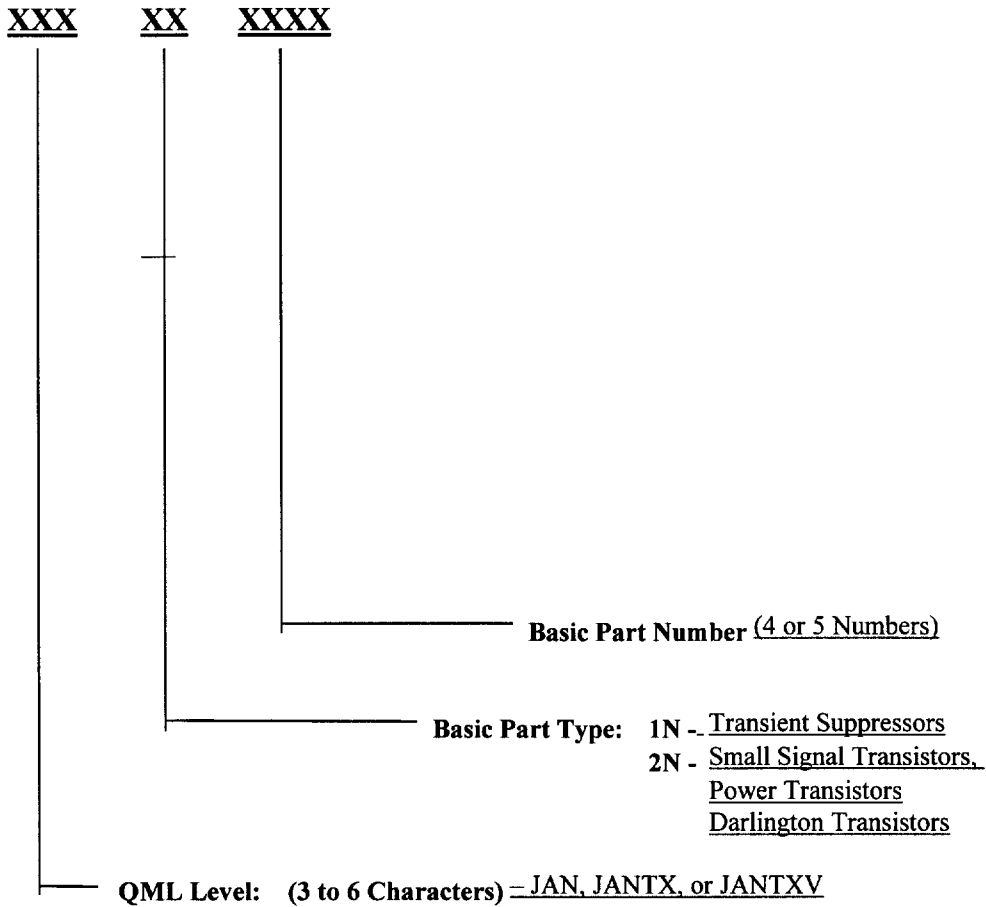

Package Outlines

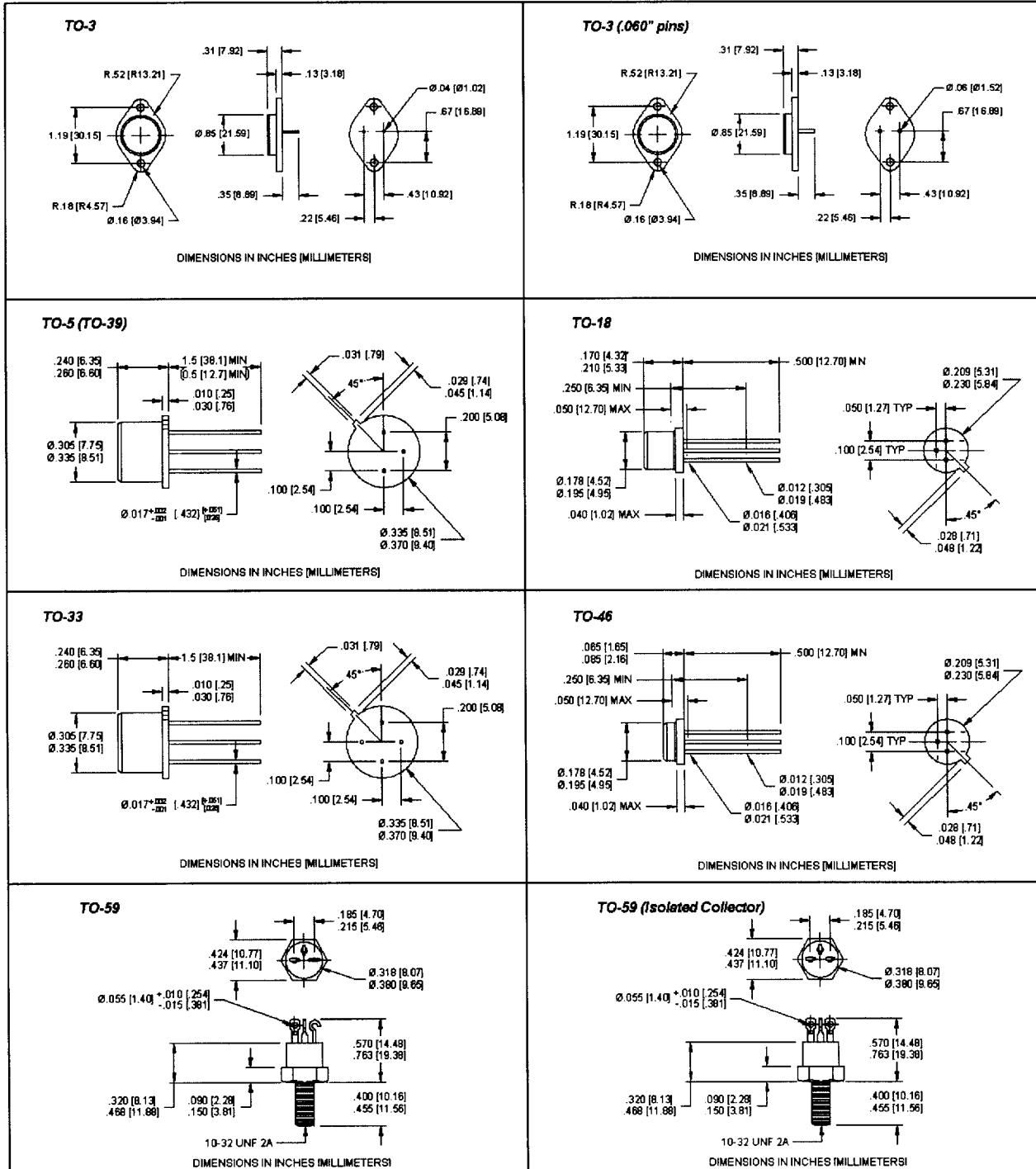

Package Outlines

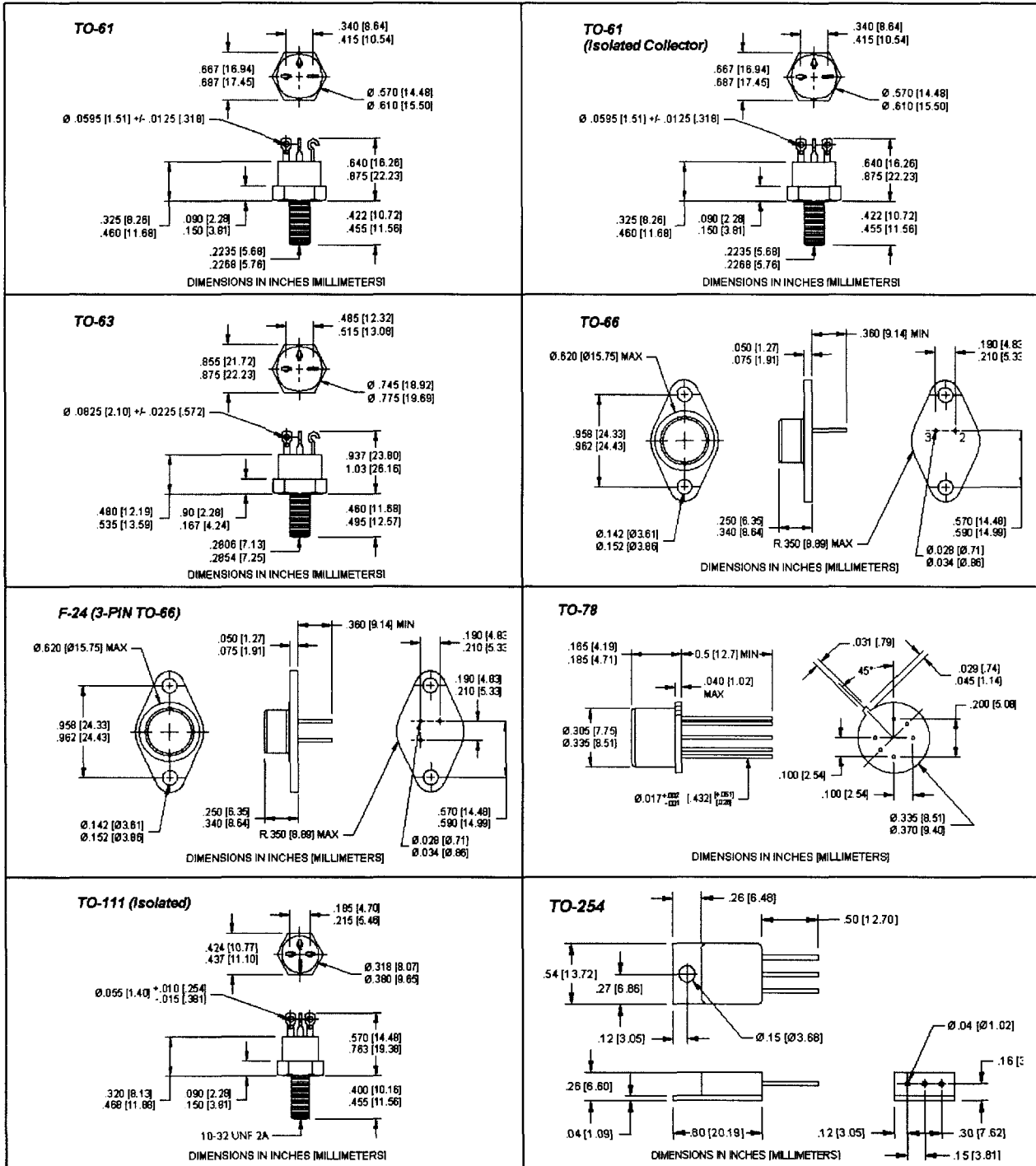

Package Outlines

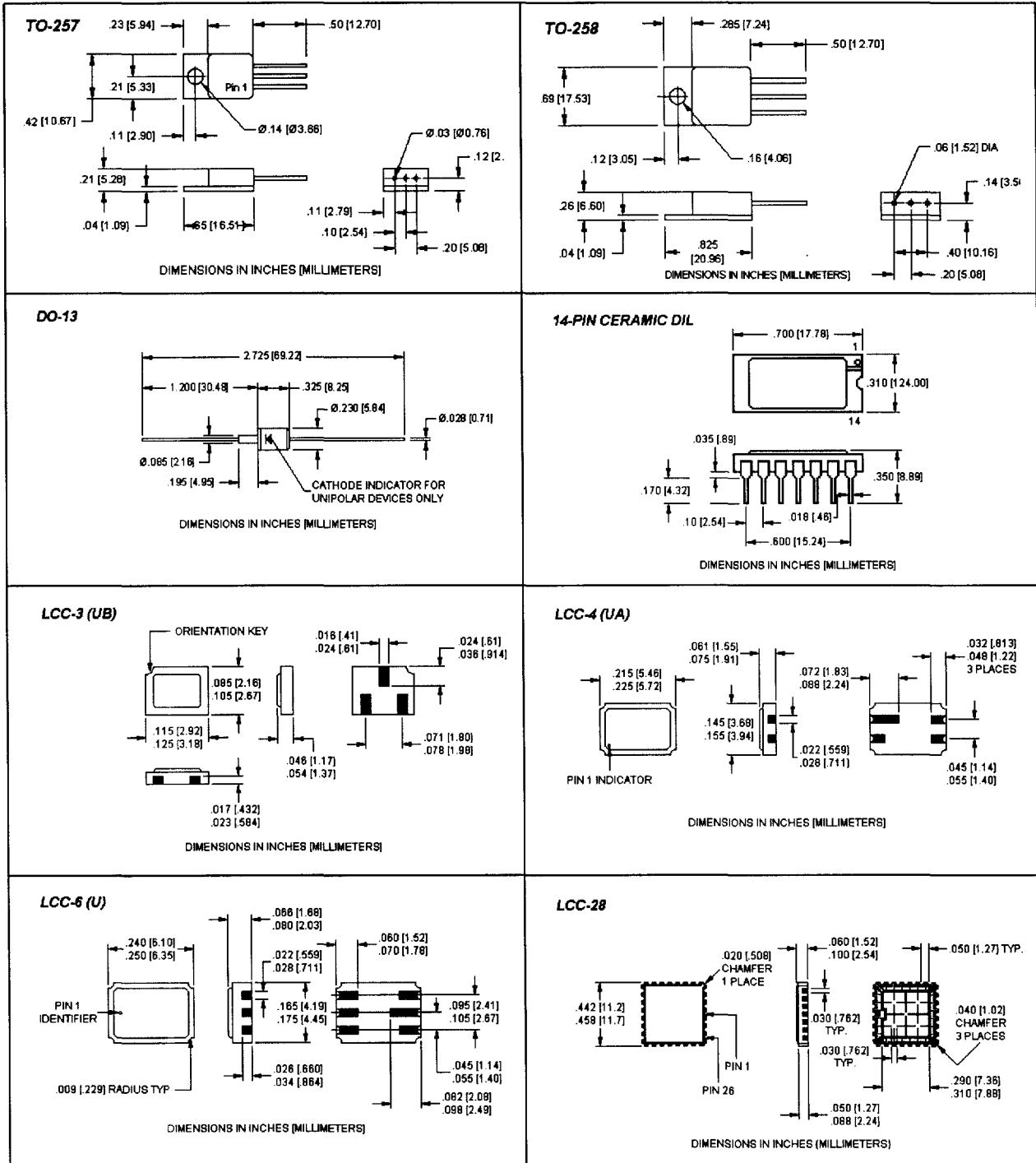

Package Outlines

