

Infrared Emitting Diode, RoHS Compliant, 950 nm, GaAs

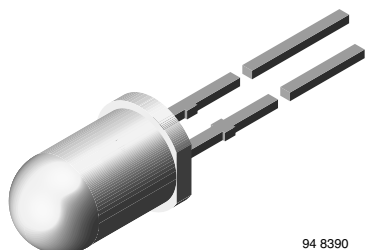

94 8390

DESCRIPTION

TSUS5400 is an infrared, 950 nm emitting diode in GaAs technology molded in a blue-gray tinted plastic package.

FEATURES

- Package type: leaded
- Package form: T-1 $\frac{3}{4}$
- Dimensions (in mm): \varnothing 5
- Leads with stand-off
- Peak wavelength: $\lambda_p = 950$ nm
- High reliability
- Angle of half intensity: $\varphi = \pm 22^\circ$
- Low forward voltage
- Suitable for high pulse current operation
- Good spectral matching with Si photodetectors
- Lead (Pb)-free component in accordance with RoHS 2002/95/EC and WEEE 2002/96/EC



RoHS
COMPLIANT

APPLICATIONS

- Infrared remote control and free air transmission systems with low forward voltage and small package requirements
- Emitter in transmissive sensors
- Emitter in reflective sensors

PRODUCT SUMMARY

COMPONENT	I_e (mW/sr)	φ (deg)	λ_p (nm)	t_r (ns)
TSUS5400	14	± 22	950	800
TSUS5401	17	± 22	950	800
TSUS5402	20	± 22	950	800

Note

Test conditions see table "Basic Characteristics"

ORDERING INFORMATION

ORDERING CODE	PACKAGING	REMARKS	PACKAGE FORM
TSUS5400	Bulk	MOQ: 4000 pcs, 4000 pcs/bulk	T-1 $\frac{3}{4}$
TSUS5401	Bulk	MOQ: 4000 pcs, 4000 pcs/bulk	T-1 $\frac{3}{4}$
TSUS5402	Bulk	MOQ: 4000 pcs, 4000 pcs/bulk	T-1 $\frac{3}{4}$

Note

MOQ: minimum order quantity

ABSOLUTE MAXIMUM RATINGS

PARAMETER	TEST CONDITION	SYMBOL	VALUE	UNIT
Reverse voltage		V_R	5	V
Forward current		I_F	150	mA
Peak forward current	$t_p/T = 0.5, t_p = 100 \mu s$	I_{FM}	300	mA
Surge forward current	$t_p = 100 \mu s$	I_{FSM}	2.5	A
Power dissipation		P_V	170	mW
Junction temperature		T_j	100	$^\circ C$
Operating temperature range		T_{amb}	- 40 to + 85	$^\circ C$
Storage temperature range		T_{stg}	- 40 to + 100	$^\circ C$
Soldering temperature	$t \leq 5$ s, 2 mm from case	T_{sd}	260	$^\circ C$
Thermal resistance junction/ambient	J-STD-051, leads 7 mm, soldered on PCB	R_{thJA}	230	K/W

Note

$T_{amb} = 25 \text{ }^\circ C$, unless otherwise specified



TSUS5400, TSUS5401, TSUS5402

Infrared Emitting Diode, RoHS Compliant, Vishay Semiconductors
950 nm, GaAs

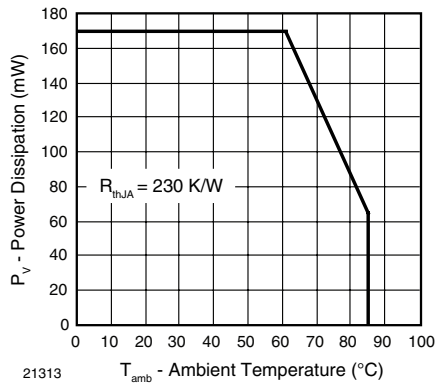

Fig. 1 - Power Dissipation Limit vs. Ambient Temperature

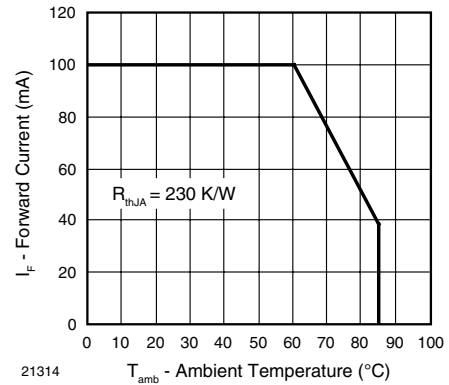

Fig. 2 - Forward Current Limit vs. Ambient Temperature

BASIC CHARACTERISTICS						
PARAMETER	TEST CONDITION	SYMBOL	MIN.	TYP.	MAX.	UNIT
Forward voltage	$I_F = 100 \text{ mA}$, $t_p = 20 \text{ ms}$	V_F		1.3	1.7	V
Temperature coefficient of V_F	$I_F = 100 \text{ mA}$	TK_{V_F}		- 1.3		mV/K
Reverse current	$V_R = 5 \text{ V}$	I_R			100	μA
Junction capacitance	$V_R = 0 \text{ V}$, $f = 1 \text{ MHz}$, $E = 0$	C_j		30		pF
Temperature coefficient of ϕ_e	$I_F = 20 \text{ mA}$	TK_{ϕ_e}		- 0.8		%/K
Angle of half intensity		ϕ		± 22		deg
Peak wavelength	$I_F = 100 \text{ mA}$	λ_p		950		nm
Spectral bandwidth	$I_F = 100 \text{ mA}$	$\Delta\lambda$		50		nm
Temperature coefficient of λ_p	$I_F = 100 \text{ mA}$	TK_{λ_p}		0.2		nm/K
Rise time	$I_F = 100 \text{ mA}$	t_r		800		ns
	$I_F = 1.5 \text{ A}$	t_r		400		ns
Fall time	$I_F = 100 \text{ mA}$	t_f		800		ns
	$I_F = 1.5 \text{ A}$	t_f		400		ns
Virtual source diameter		d		2.9		mm

Note

$T_{amb} = 25 \text{ }^\circ\text{C}$, unless otherwise specified

TYPE DEDICATED CHARACTERISTICS							
PARAMETER	TEST CONDITION	PART	SYMBOL	MIN.	TYP.	MAX.	UNIT
Forward voltage	$I_F = 1.5 \text{ A}$, $t_p = 100 \text{ }\mu\text{s}$	TSUS5400	V_F		2.2	3.4	V
		TSUS5401	V_F		2.2	3.4	V
		TSUS5402	V_F		2.2	2.7	V
Radiant intensity	$I_F = 100 \text{ mA}$, $t_p = 20 \text{ ms}$	TSUS5400	I_e	7	14	35	mW/sr
		TSUS5401	I_e	10	17	35	mW/sr
		TSUS5402	I_e	15	20	35	mW/sr
	$I_F = 1.5 \text{ A}$, $t_p = 100 \text{ }\mu\text{s}$	TSUS5400	I_e	60	140		mW/sr
		TSUS5401	I_e	85	160		mW/sr
		TSUS5402	I_e	120	190		mW/sr
Radiant power	$I_F = 100 \text{ mA}$, $t_p = 20 \text{ ms}$	TSUS5400	ϕ_e		13		mW
		TSUS5401	ϕ_e		14		mW
		TSUS5402	ϕ_e		15		mW

Note

$T_{amb} = 25 \text{ }^\circ\text{C}$, unless otherwise specified

BASIC CHARACTERISTICS

$T_{amb} = 25\text{ }^{\circ}\text{C}$, unless otherwise specified

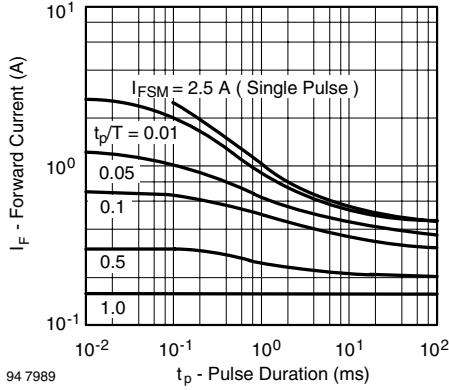

Fig. 3 - Pulse Forward Current vs. Pulse Duration

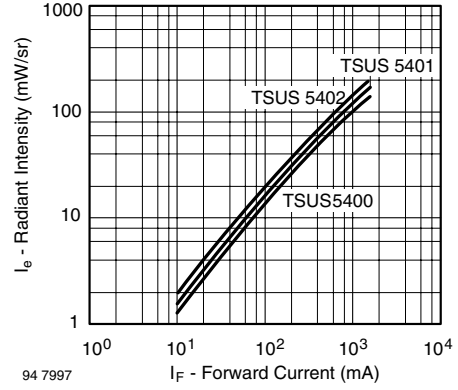

Fig. 6 - Radiant Intensity vs. Forward Current

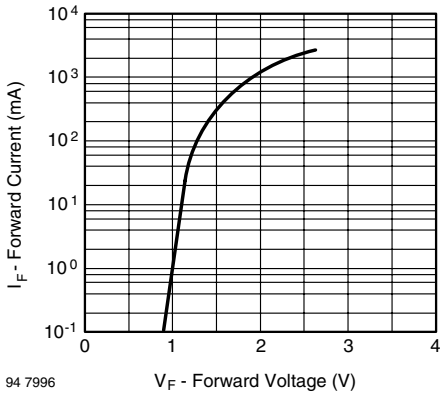

Fig. 4 - Forward Current vs. Forward Voltage

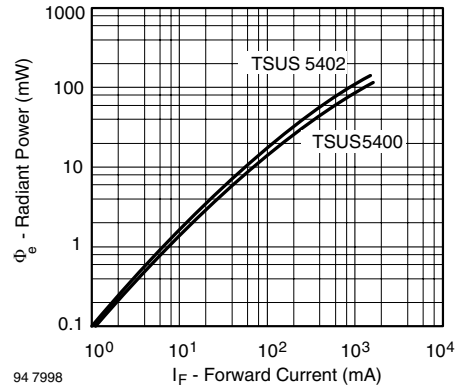

Fig. 7 - Radiant Power vs. Forward Current

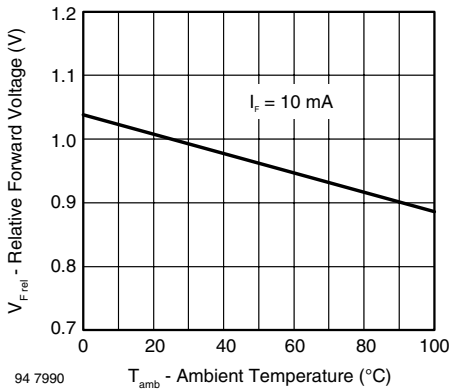

Fig. 5 - Relative Forward Voltage vs. Ambient Temperature

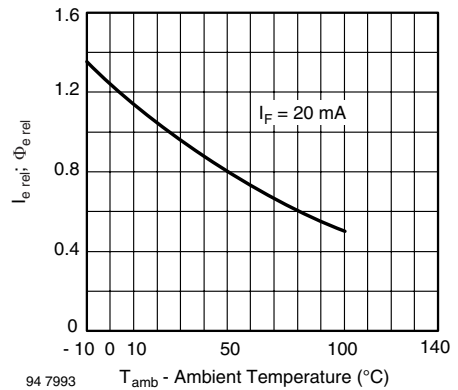

Fig. 8 - Relative Radiant Intensity/Power vs. Ambient Temperature



TSUS5400, TSUS5401, TSUS5402

Infrared Emitting Diode, RoHS Compliant, Vishay Semiconductors
950 nm, GaAs

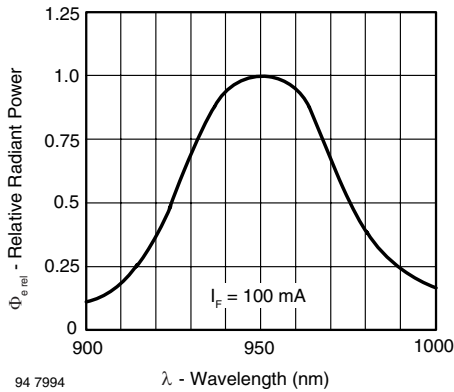

Fig. 9 - Relative Radiant Power vs. Wavelength

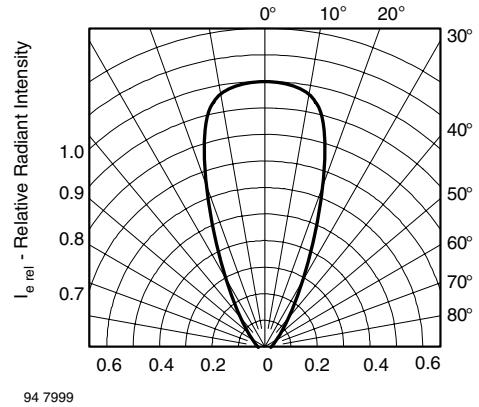
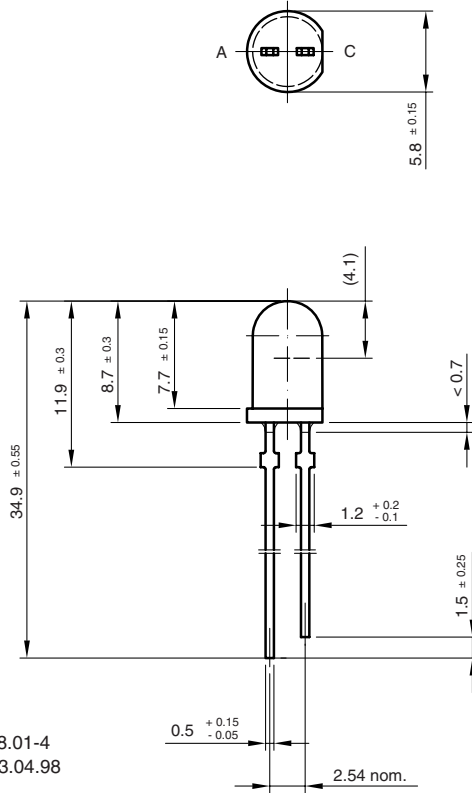
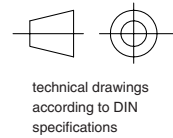
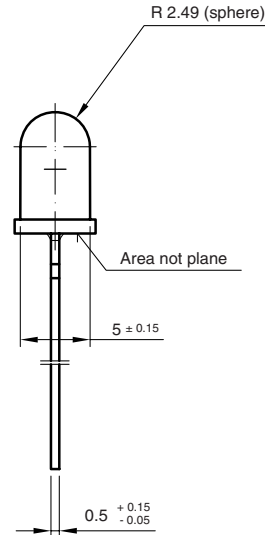

Fig. 10 - Relative Radiant Intensity vs. Angular Displacement

PACKAGE DIMENSIONS in millimeters



6.544-5258.01-4
Issue: 4; 23.04.98
96 12119



technical drawings
according to DIN
specifications



Disclaimer

All product specifications and data are subject to change without notice.

Vishay Intertechnology, Inc., its affiliates, agents, and employees, and all persons acting on its or their behalf (collectively, "Vishay"), disclaim any and all liability for any errors, inaccuracies or incompleteness contained herein or in any other disclosure relating to any product.

Vishay disclaims any and all liability arising out of the use or application of any product described herein or of any information provided herein to the maximum extent permitted by law. The product specifications do not expand or otherwise modify Vishay's terms and conditions of purchase, including but not limited to the warranty expressed therein, which apply to these products.

No license, express or implied, by estoppel or otherwise, to any intellectual property rights is granted by this document or by any conduct of Vishay.

The products shown herein are not designed for use in medical, life-saving, or life-sustaining applications unless otherwise expressly indicated. Customers using or selling Vishay products not expressly indicated for use in such applications do so entirely at their own risk and agree to fully indemnify Vishay for any damages arising or resulting from such use or sale. Please contact authorized Vishay personnel to obtain written terms and conditions regarding products designed for such applications.

Product names and markings noted herein may be trademarks of their respective owners.