



CRNA/CRNB20

20Amp - 400/600/800/1200V - RECTIFIER

Applications

- Input Rectification
- Low Frequency Freewheel
- Battery Isolation

- > Suitable for General Purpose Applications
- > Isolated and Non-Isolated Tab
- > V_R/V_{RRM} 400, 600, 800, 1200V

Absolute Maximum Ratings

	CONDITIONS	SYMBOL	RATING
RMS On-State Current (full sine wave)	$T_c = 95^\circ\text{C}$ $T_c = 80^\circ\text{C}$	TO-220AB TO-220AB Iso $I_{F(RMS)}$	20A
Average On-State Current	$T_c = 95^\circ\text{C}$ $T_c = 80^\circ\text{C}$	TO-220AB TO-220AB Iso $I_{F(AV)}$	12.7A
Non Repetitive Surge Peak On-State Current (Full Cycle, T_j Initial = 25°C)	F = 50 Hz F = 60 Hz	I_{FSM}	255A 300A
I^2t Value for fusing	tp = 10 ms	I^2t	374A ² s
Storage Temperature Range		T_{stg}	-40 to +150°C
Operating Junction Temperature Range		T_j	-40 to +125°C
Isolation Voltage (CRNA Series only)		V_{ISO}	2500 V_{RMS}

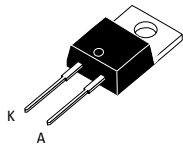

TO-220AB Isolated
(CRNA15)

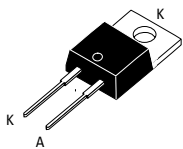

TO-220AB Non-Isolated
(CRNB15)



Electrical Characteristics

V_{FM} @ 20A	$T_j = 25^\circ\text{C}$	1.1V
I_{RM} @ $V_R = V_{RRM}$	$T_j = 25^\circ\text{C}$	0.1mA
I_{RM} @ $V_R = V_{RRM}$	$T_j = 125^\circ\text{C}$	1.0mA

Thermal Resistances

	SYMBOL	RATING
Junction to Case (AC)	TO-220AB $R_{th(j-c)}$	1.8°C/W
Junction to Case (AC)	TO-220AB Isolated $R_{th(j-c)}$	2.7°C/W
Junction to Ambient	TO-220AB $R_{th(j-a)}$	60°C/W
Junction to Ambient	TO-220AB Isolated $R_{th(j-a)}$	60°C/W

GENERAL NOTES

1. All parameters at 25 degrees C unless otherwise specified.

Dimensions

REF.	Millimeters			Inches		
	Min.	Typ.	Max.	Min.	Typ.	Max.
A	15.24		15.75	0.6		0.62
B		3.23			0.127	
C	12.78		13.79	0.503		0.543
D	9.96		10.36	0.392		0.408
E	0.69		0.94	0.027		0.037
F	1.22		1.32	0.048		0.052
G	4.62		4.83	0.182		0.19
H	0.46		0.61	0.018		0.024
I	2.49		2.84	0.098		0.112
J	2.39		2.69	0.094		0.106
K	6.48		6.88	0.255		0.271
L	3.78		3.89	0.149		0.153
M	15.49	16	16.51	0.61	0.63	0.65
N	2.59		2.9	0.102		0.114
O	0.99		1.55	0.039		0.061
Q		2.67			0.105	

Part Number Designation

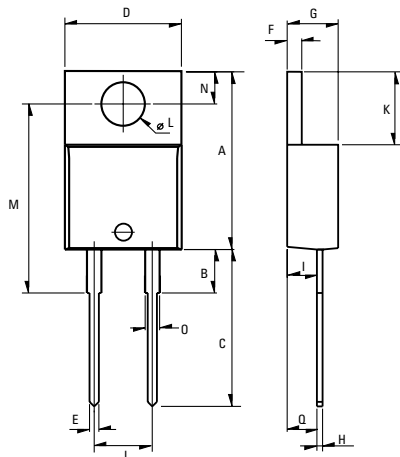
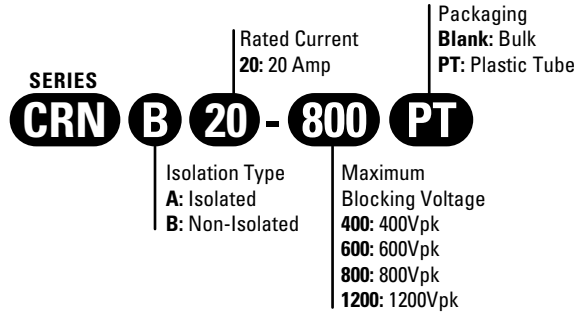

Weight: 2.3g (0.08 oz)

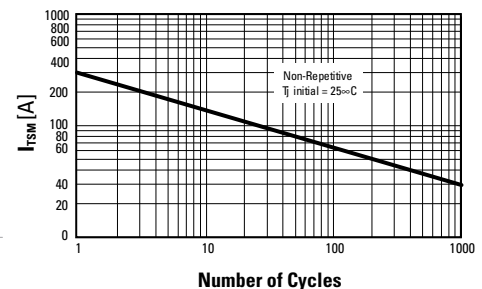
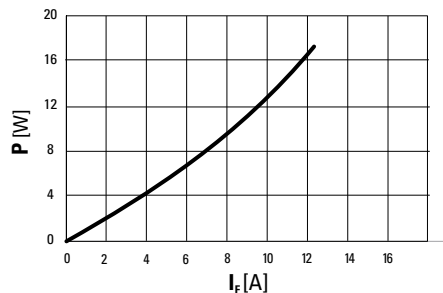
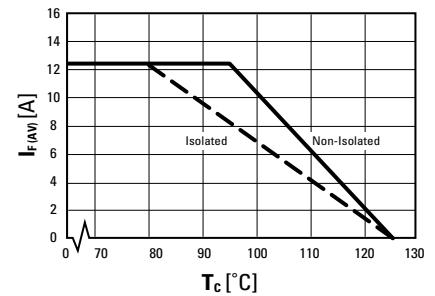
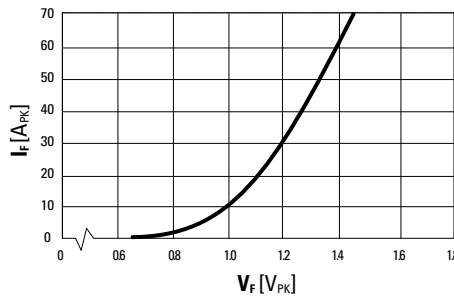

ISO9001 Certified

Approvals

UL - Pending

USA

Sales Support (877) 502-5500

Tech Support (877) 702-7700

Fax (619) 710-8540

Email: sales@crydom.com

Crydom Corp

2320 Paseo de las Americas, Suite 201

San Diego, CA 92154

EUROPE - UK

Telephone +44 (0) 1202 365070

Fax +44 (0) 1202 365090

Email: intsales@crydom.com

Crydom International Ltd.

7 Cobham Road

Ferndown Industrial Estate

Wimborne, Dorset BH21 7PE

Germany

Telephone +49 (0) 180 3000 506

ASIA - Thailand

Telephone +66 (0)2 665 2517

Fax +66 (0)2 665 2588

Crydom Asia

18/8 Fico Place 12th Floor

Soi Sukhumvit 21 (Asoke)

Klongtoey Nua, Wattana

Bangkok, Thailand 10110