



Size 20 Signal and
Thermocouple Contacts, Fixed
Military/Industrial
Quality Connectors

IEC Publication 807-2
Performance Level One
MIL-DTL-24308

U.L. Recognized File #E49351
CSA Recognized File #LR54219

Telecommunication
U.L. File #14098



Harmo-D Series connectors are Military/Industrial quality rectangular connectors designed for use in sheltered, mildly corrosive environments having a wide range of temperature, pressure and humidity changes. These fixed contact connectors are qualified to MIL-DTL-24308 and meet the performance requirements of IEC 807-2, Performance Level One.

Harmo-D Series connectors utilize precision machined contacts which are fixed within the connector body. The female contact features a rugged, closed entry design contact with a stainless steel shroud.

Five standard connector variants are offered in arrangements of 9, 15, 25, 37 and 50 contacts. Each connector variant is available with contact terminations for solder cup, wrap post and straight and 90° printed board mount terminations with Inch and Metric footprints. Harmo-D Series connectors are mateable and compatible with all D-Subminiature connectors conforming to IEC 807-2 and MIL-DTL-24308.

A wide assortment of printed board mounting hardware, cable support hoods and locking systems is available from stock.

Harmo-D Series connectors conform to EIA RS 232 and RS 449, and CCITT X.24 interface connection requirements.



Contact Technical
Sales for details.

HARMO-D SERIES TECHNICAL CHARACTERISTICS

MATERIALS AND FINISHES:

Insulator:	Glass filled DAP per ASTM-D-5948, SDG-F, UL 94V-0, green color.
Contacts:	Male contacts – precision machined brass. Female contacts – precision machined high tensile phosphor bronze with stainless steel shroud.
Contact Plating:	Military performance – 0.000050 inch [1.27 microns] gold over copper plate. Industrial performance – gold flash over nickel plate. Other finishes available upon request.
Shells:	Steel with tin plate; zinc and cadmium plate with dichromate seal, stainless steel, passivated. Other materials and finishes available upon request.
Mounting Spacers and Brackets:	Nylon plastic, or brass with tin plate; zinc plate with dichromate seal.
Push-On Fasteners:	Phosphor bronze or beryllium copper with tin plate.
Jackscrew Systems:	Steel with zinc plate and dichromate seal, or clear zinc plate.
Vibration Lock Systems:	Slide lock and lock tabs, steel with nickel plate.
Hoods:	Thermoplastic UL 94V-0. Composite, brass or steel with zinc plate and dichromate seal.

ELECTRICAL CHARACTERISTICS:

Contact Current Rating:	7.5 amperes nominal.
Initial Contact Resistance:	0.005 ohms maximum.
Proof Voltage:	1000 V r.m.s.
Insulator Resistance:	5 G ohms.
Clearance and Creepage Distance [minimum]:	0.039 inch [1.0mm].
Working Voltage:	300 V r.m.s.

CLIMATIC CHARACTERISTICS:

Temperature Range:	-55°C to +125°C.
Damp Heat, Steady State:	56 days.

MECHANICAL CHARACTERISTICS:

Fixed Contacts:	Size 20 contact, male contact – 0.040 inch [1.02mm] diameter. Female contact – closed entry design with stainless steel shroud.
Contact Retention In Insulator:	9 lbs. [40 N].
Resistance To Solder Iron Heat:	650°F [350°C] for 10 seconds duration per IEC 512-6.
Contact Terminations:	Solder cup contacts – 0.042 inch [1.06mm] minimum hole diameter in solder style contact for 20 AWG [0.5mm ²] wire maximum. Straight Printed Board Mount – 0.028 inch [0.71mm] diameter and 0.024 inch [0.61mm] diameter. 90° Printed Board Mount – 0.028 [0.71mm] diameter for Inch System footprint, and 0.024 [0.61mm] diameter for European Metric footprint. Wrap Post – 0.025 inch [0.64mm] square
Shells:	Male shells may be dimpled for EM/ESD ground paths.
Polarization:	Trapezoidally shaped shells and polarized jackscrews.
Mounting To Angle Brackets:	Jackscrews and riveted fasteners with 0.120 inch [3.05mm] clearance hole, and threaded riveted fasteners with 4-40 threads and nylon lock inserts.
Mounting To Printed Board:	Rapid installation push-on fasteners an mounting posts.
Locking Systems:	Jackscrews and vibration locking systems.
Mechanical Operations:	1000 operations minimum per IEC 512-5.

THERMOCOUPLE CONTACTS:

Straight and right angle PCB mount contacts are available, please contact Technical Sales for details.

Size 20 crimp contacts are available in RD series, see page 29 for details.

DIMENSIONS ARE IN INCHES [MILLIMETERS].
ALL DIMENSIONS ARE SUBJECT TO CHANGE.



Positronic Industries
connectpositronic.com

MILITARY QUALITY, FIXED CONTACT SUBMINIATURE-D CONNECTORS

D-Sub

FOR MILITARY AND SEVERE INDUSTRIAL ENVIRONMENTAL APPLICATIONS

CONTACT VARIANTS

FACE VIEW OF MALE OR REAR VIEW OF FEMALE

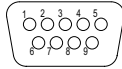

HDC 9

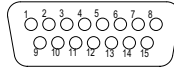

HDC 15

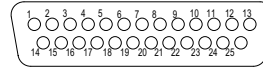

HDC 25

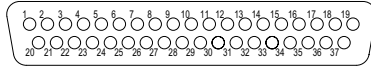

HDC 37

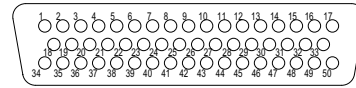

HDC 50

STANDARD SHELL ASSEMBLY

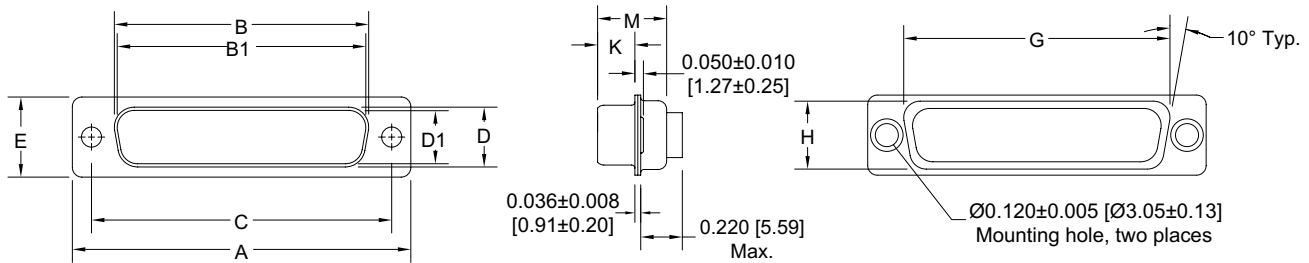

OPTIONAL SHELL ASSEMBLY [0, 02]

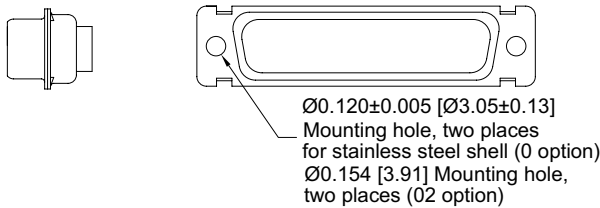

OPTIONAL SHELL ASSEMBLY WITH UNIVERSAL FLOAT MOUNTS [F]

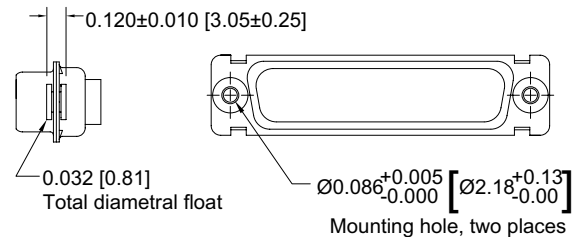

CONNECTOR VARIANT SIZES	A ±0.015 [0.38]	B ±0.005 [0.13]	B1 ±0.005 [0.13]	C ±0.005 [0.13]	D ±0.005 [0.13]	D1 ±0.005 [0.13]	E ±0.015 [0.38]	G ±0.010 [0.25]	H ±0.010 [0.25]	K ±0.005 [0.13]	M ±0.010 [0.25]
HDC 9 M	1.213 [30.81]		0.666 [16.92]	0.984 [24.99]		0.329 [8.36]	0.494 [12.55]	0.759 [19.28]	0.422 [10.72]	0.233 [5.92]	0.422 [10.72]
HDC 9 F	1.213 [30.81]	0.643 [16.33]		0.984 [24.99]	0.311 [7.90]		0.494 [12.55]	0.759 [19.28]	0.422 [10.72]	0.243 [6.17]	0.429 [10.90]
HDC 15 M	1.541 [39.14]		0.994 [25.25]	1.312 [33.32]		0.329 [8.36]	0.494 [12.55]	1.083 [27.51]	0.422 [10.72]	0.233 [5.92]	0.422 [10.72]
HDC 15 F	1.541 [39.14]	0.971 [24.66]		1.312 [33.32]	0.311 [7.90]		0.494 [12.55]	1.083 [27.51]	0.422 [10.72]	0.243 [6.17]	0.429 [10.90]
HDC 25 M	2.088 [53.04]		1.534 [38.96]	1.852 [47.04]		0.329 [8.36]	0.494 [12.55]	1.625 [41.28]	0.422 [10.72]	0.230 [5.84]	0.426 [10.82]
HDC 25 F	2.088 [53.04]	1.511 [38.38]		1.852 [47.04]	0.311 [7.90]		0.494 [12.55]	1.625 [41.28]	0.422 [10.72]	0.243 [6.17]	0.429 [10.90]
HDC 37 M	2.729 [69.32]		2.182 [55.42]	2.500 [63.50]		0.329 [8.36]	0.494 [12.55]	2.272 [57.71]	0.422 [10.72]	0.230 [5.84]	0.426 [10.82]
HDC 37 F	2.729 [69.32]	2.159 [54.84]		2.500 [63.50]	0.311 [7.90]		0.494 [12.55]	2.272 [57.71]	0.422 [10.72]	0.243 [6.17]	0.429 [10.90]
HDC 50 M	2.635 [66.93]		2.079 [52.81]	2.406 [61.11]		0.441 [11.20]	0.605 [15.37]	2.178 [55.32]	0.534 [13.56]	0.230 [5.84]	0.426 [10.82]
HDC 50 F	2.635 [66.93]	2.064 [52.43]		2.406 [61.11]	0.423 [10.74]		0.605 [15.37]	2.178 [55.32]	0.534 [13.56]	0.243 [6.17]	0.429 [10.90]



SOLDER CUP CONNECTOR

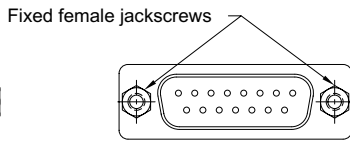
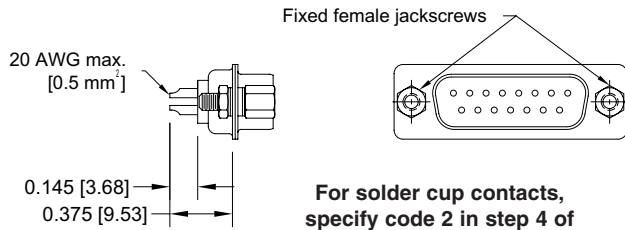

For solder cup contacts, specify code 2 in step 4 of ordering information.

Typical Part Number: **HDC15M200T2Z**

Fixed male and female polarized jackscrews available. Specify code T6 in step 7 of ordering information.

Typical Part Number: **HDC15M200T6Z**

STRAIGHT PRINTED BOARD MOUNT CONNECTOR

CODE NUMBER	L	ØD
3	0.170 [4.32]	0.028 [0.71]
32	0.375 [9.53]	0.028 [0.71]
36	0.236 [6.00]	0.024 [0.61]

For straight printed board mount contacts, specify code no. in step 4 of ordering information.

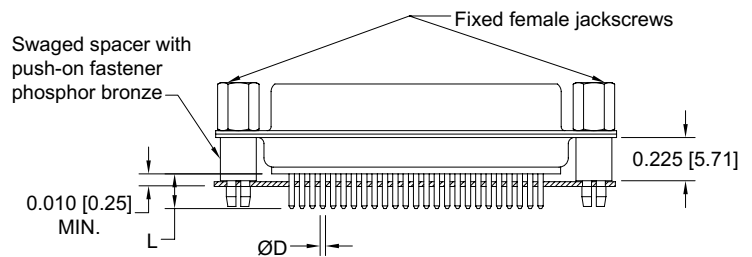

Typical Part Number: **HDC25F3S60T0**

WRAP POST CONNECTOR

For wrap post contacts, specify code 6 in step 4 of ordering information.

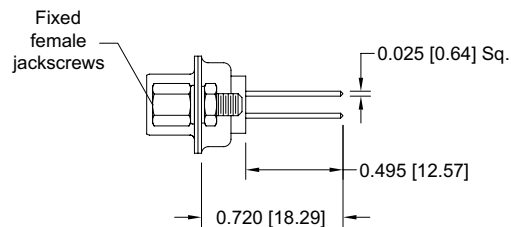

Typical part number: **HDC15F600T0**

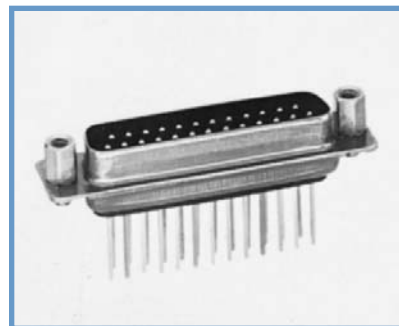

HDC25M6S50T0



Positronic Industries
connectpositronic.com

MILITARY QUALITY, FIXED CONTACT SUBMINIATURE-D CONNECTORS

D-Sub

FOR MILITARY AND SEVERE INDUSTRIAL ENVIRONMENTAL APPLICATIONS

90° PRINTED BOARD MOUNT CONNECTOR CODE 5, 0.283 [7.19] CONTACT EXTENSION

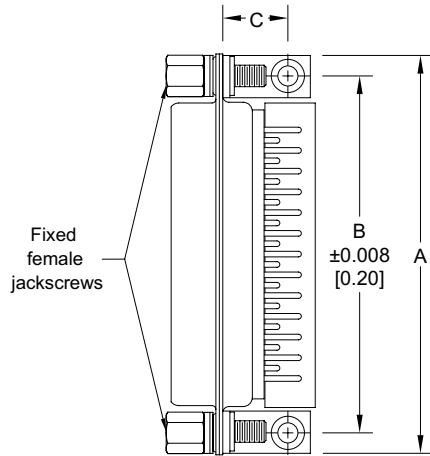

HDC**5B3*** 0.283 [7.19] CONTACT EXTENSION					
PART NUMBER	A	B	C	D	E
HDC9*5B3***	1.204 [30.58]	0.984 [24.99]	0.339 [8.61]	0.283 [7.19]	0.112 [2.84]
HDC15*5B3***	1.532 [38.91]	1.312 [33.32]	0.339 [8.61]	0.283 [7.19]	0.112 [2.84]
HDC25*5B3***	2.072 [52.63]	1.852 [47.04]	0.339 [8.61]	0.283 [7.19]	0.112 [2.84]
HDC37*5B3***	2.720 [69.09]	2.500 [63.50]	0.339 [8.61]	0.283 [7.19]	0.112 [2.84]
HDC50*5B3***	2.626 [66.70]	2.406 [61.11]	0.395 [10.03]	0.283 [7.19]	0.112 [2.84]

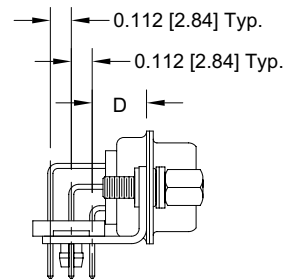
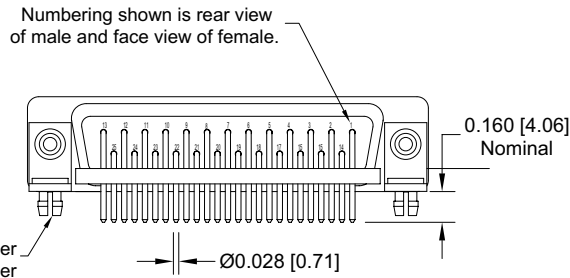
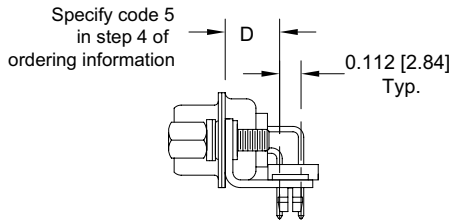

Typical Part Number:
HDC25M5R7NT2X

Typical Part Number:
HDC50F5R7NTX

90° PRINTED BOARD MOUNT CONNECTOR CODE 42, 0.370 [9.40] CONTACT EXTENSION

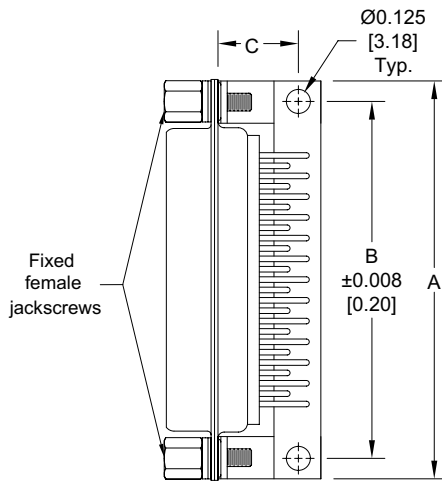

HDC**42B3*** 0.370 [9.40] CONTACT EXTENSION					
PART NUMBER	A	B	C	D	E
HDC9*42B3***	1.204 [30.58]	0.984 [24.99]	0.420 [10.67]	0.370 [9.40]	0.100 [2.54]
HDC15*42B3***	1.532 [38.91]	1.312 [33.32]	0.420 [10.67]	0.370 [9.40]	0.100 [2.54]
HDC25*42B3***	2.072 [52.63]	1.852 [47.04]	0.420 [10.67]	0.370 [9.40]	0.100 [2.54]
HDC37*42B3***	2.720 [69.09]	2.500 [63.50]	0.420 [10.67]	0.370 [9.40]	0.100 [2.54]
HDC50*42B3***	2.626 [66.70]	2.406 [61.11]	0.470 [11.94]	0.370 [9.40]	0.100 [2.54]

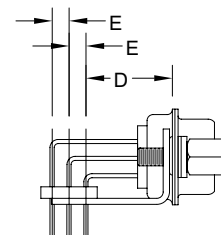
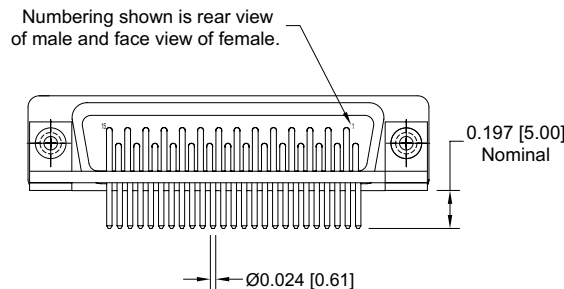
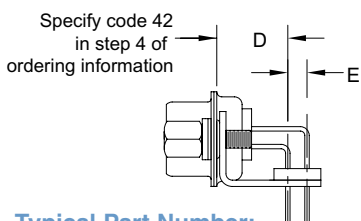

Typical Part Number:
HDC25M42B30T2X

Typical Part Number:
HDC50M42B30T2X



90° AND STRAIGHT PRINTED BOARD
CONTACT HOLE PATTERN

Hole identification shown for male connector, use mirror image for female connector.
Mount connector with mating face positioned to follow direction of arrows.

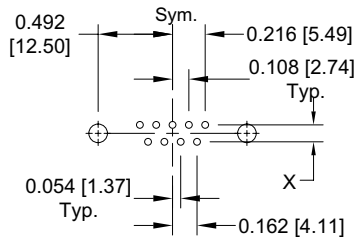

HDC 9

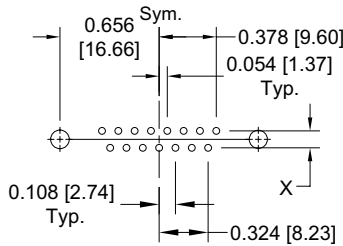

HDC 15

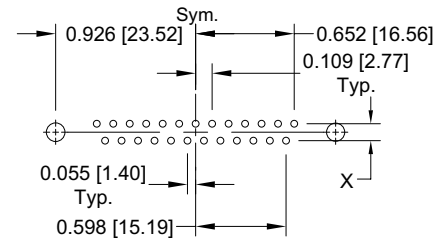

HDC 25

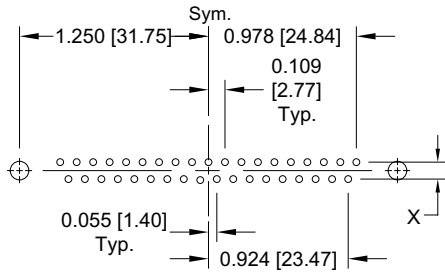

HDC 37

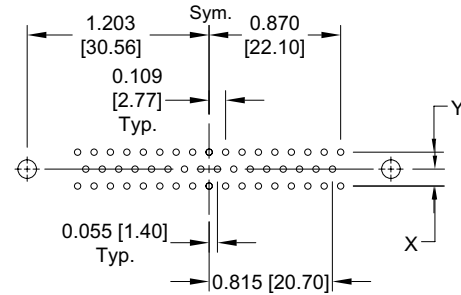

HDC 50

CODE NUMBER	X	Y
3	0.112 [2.84]	0.224 [5.69]
5	0.112 [2.84]	0.224 [5.69]
32	0.112 [2.84]	0.224 [5.69]
36	0.112 [2.84]	0.224 [5.69]
*42	0.100 [2.54]	0.200 [5.08]

*Metric system,
European contact hole pattern.

Suggest 0.039 [0.99] Ø hole for 0.024 [0.61] Ø contact termination positions.
Suggest 0.045 [1.14] Ø hole for 0.028 [0.71] Ø contact termination positions.
Suggest 0.123 ±0.003 [3.12 ±0.08] Ø hole for mounting connector with push-on fasteners.





Positronic Industries
connectpositronic.com

MILITARY QUALITY, FIXED CONTACT SUBMINIATURE-D CONNECTORS

FOR MILITARY AND SEVERE INDUSTRIAL ENVIRONMENTAL APPLICATIONS

D-Sub

ORDERING INFORMATION - CODE NUMBERING SYSTEM

Specify Complete Connector By Selecting An Option From Step 1 Through 8

STEP	1	2	3	4	5	6	7	8	9
EXAMPLE	HDC	37	F	5	B3	0	T	0	—

STEP 1 - BASIC SERIES

HDC Series

STEP 2 - CONNECTOR VARIANTS

9, 15, 25, 37, 50

STEP 3 - CONNECTOR GENDER

M - Male
F - Female

STEP 4 - CONTACT TERMINATION TYPE

- 2 - Solder cup.
- 3 - Solder, Straight Printed Board Mount with 0.170 [4.32] Tail Length.
- 32 - Solder, Straight Printed Board Mount with 0.375 [9.52] Tail Length.
- 36 - Solder, Straight Printed Board Mount with 0.236 [5.99] Tail Length.
- 42 - Solder, Metric System 90° Printed Board Mount with 0.370 [9.40] Contact Extension.
- 5 - Solder, 90° Printed Board Mount with 0.283 [7.19] Contact Extension.
- 6 - Wrap Post.

*STEP 5 - MOUNTING STYLE

- 0 - Mounting Hole, 0.120 [3.05] Ø.
- 02 - Mounting Hole, 0.154 [3.91] Ø.
- B3 - Bracket, Mounting, 90° Metal with Cross Bar.
- B8 - Bracket, Mounting, 90° Plastic with Cross Bar.
- F - Float Mounts, Universal.
- P - Threaded Post, Brass, 0.225 [5.71] Length.
- P2 - Threaded Post, Nylon, 0.225 [5.71] Length.
- R2 - Bracket, Mounting, 90° Metal, Swaged to Connector with 4-40 Thread Fixed Female Jackscrews with Cross Bar.
- R6 - Bracket, Mounting, 90° Metal, Swaged to Connector with 0.120 [3.05] Ø Mounting Hole with Cross Bar.
- R7 - Bracket, Mounting, 90° Metal, Swaged to Connector with 4-40 Threads with Cross Bar.
- R8 - Bracket, Mounting, 90° Metal, Swaged to Connector with 4-40 Locknut with Cross Bar.
- S - Swaged Spacer, 4-40 Threads, 0.225 [5.71] Length.
- S2 - Swaged Spacer, 4-40 Threads, 0.125 [3.18] Length.
- S5 - Swaged Locknut, 4-40 Threads.
- S6 - Swaged Spacer with Push-on Fastener, 4-40 Threads, 0.225 [5.71] Length.
- S7 - Swaged Spacer with Push-on Fastener for use with Ferrite Inductor, 4-40 Threads, 0.375 [9.53] Length.

STEP 9 - SPECIAL OPTIONS

**CONTACT TECHNICAL SALES
FOR ORDERING DETAILS OF
THE FOLLOWING:**

Other Special Requirements.
Straight and Right Angle Thermocouple
PCB mount contacts

STEP 8 - SHELL OPTIONS

- 0 - Zinc Plated with Dichromate Seal.
- S - Stainless Steel.
- X - Tin Plated.
- Z - Tin Plated and Dimpled (male connectors only).
- C - Cadmium plated with Dichromate Seal

*STEP 7 - LOCKING AND POLARIZING SYSTEMS

- 0 - None.
- V3 - Lock Tab, connector front panel mounted.
- V5 - Lock Tab, connector rear panel mounted.
- VL - Lock Lever, used with Hoods Only.
- T - Fixed Female Jackscrews.
- T2 - Fixed Female Jackscrews.
- T6 - Fixed Male and Female Polarized Jackscrews.
- E - Rotating Male Jackscrews.
- E2 - Rotating Male Screw Locks.
- E3 - Rotating Male with internal hex for 3/32 hex drives
- E6 - Rotating Male and Female Polarized Jackscrews.

*STEP 6 - HOODS AND PUSH-ON FASTENERS

- 0 - None.
- J - Hood, Top Opening, Plastic.
- L - Hood, Side Opening, Plastic.
- Y - Hood, Top Opening, Plastic with Rotating Male Jackscrews. Available in size 50 only.
- Y6 - Hood, Top Opening, Plastic with Rotating Male and Female Polarized Jackscrews. Available in size 50 only.
- Z - Hood, Top or Side Opening, Robust and Extended Height, Composite and Plastic with Rotating Male Jackscrews.
- H - Hood, Top Opening, Metal. Available in size 15, 25, 37 and 50 only.
- G - Hood, EMI/RFI, Metal.
- W - Hood, Top or Side Opening, Plastic. Available in size 9, 15, and 25 only.
- N - Push-on Fastener, for 90° Mounting Brackets.
- **F - Ferrite Inductor.

*For additional information on accessories listed in steps 5, 6 and 7, see Accessory Catalog.

**Ferrite inductor is available on contact types 32, 36 and 6 only.



Contact Technical
Sales for details.