

## High Density Dual Port Series

### PROFESSIONAL QUALITY PRINTED BOARD MOUNT HIGH DENSITY DUAL PORT VERTICALLY STACKED CONNECTOR ASSEMBLY FOR SHELTERED INDOOR/OUTDOOR ENVIRONMENTAL APPLICATIONS

Size 22 Contacts.  
Two Connectors Vertically  
Stacked and Assembled  
As a Single Connector Unit  
Professional Quality  
Connectors

U.L. Recognized  
File #E49351

CSA Recognized  
File #LR54219

Telecommunication  
U.L. File #14098

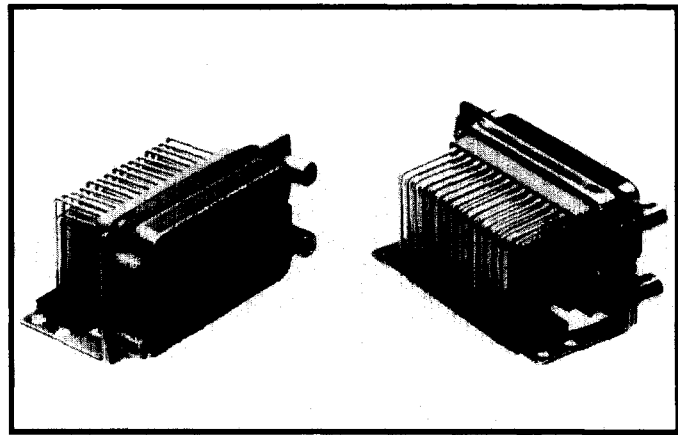

High Density Dual Port Series connectors utilize two high density connectors vertically stacked and assembled into a single connector unit, which permits saving of panel and printed board space, and decreases final assembly costs.

High Density Dual Port Series connectors are professional quality connectors recommended for use in sheltered, non-corrosive indoor and outdoor environments having normal ventilation.

Connector contact variants are 15, 26, 44 and 62. Connector genders can be mixed, i.e., one male and one female connector within one High Density Dual Port assembly. The two connectors

may be spaced apart to three standard dimensional spacings. The connector may also be partially populated with contacts which are installed in the connector body to customer selected contact positions.

Mounting angle brackets can be ordered riveted to the connector by specifying R2, R6, R7 or R8 options. Locking systems are available utilizing 4-40 threaded jackscrew systems, polarized or nonpolarized, or with a quick release Vibration Lock System for either front or rear panel mounted connectors.

High Density Dual Port Series connectors comply with the dimensional requirements of MIL-C-24308.

## HIGH DENSITY DUAL PORT SERIES TECHNICAL CHARACTERISTICS

### MATERIALS AND FINISHES:

<b>Insulator:</b>	Glass-filled polyester per MIL-M-24519, UL 94V-0. Black color.
<b>Contacts:</b>	Male and female contacts — precision machined high tensile phosphor bronze.
<b>Contact Plating:</b>	Gold flash over nickel plate.
<b>Shells:</b>	Steel with tin plate, or zinc plate with dichromate seal.
<b>Mounting Spacers and Brackets:</b>	Steel or brass with tin plate, or zinc with dichromate seal.
<b>Cross Bar:</b>	Nylon resin, UL 94V-0, black color.
<b>Push-On Fasteners:</b>	Beryllium copper with tin plate.
<b>Jackscrew Systems:</b>	Steel with zinc plate and dichromate seal, or clear zinc plate.
<b>Vibration Lock Systems:</b>	Lock tabs, steel with nickel plate.

### ELECTRICAL CHARACTERISTICS:

<b>Contact Current Rating:</b>	3 amperes.
<b>Initial Contact Resistance:</b>	0.010 ohms maximum.
<b>Proof Voltage:</b>	1000 V r.m.s.
<b>Insulator Resistance:</b>	5 G ohms.
<b>Clearance and Creepage Distance (minimum):</b>	0.039 inch (1.0mm).
<b>Working Voltage:</b>	300 V r.m.s.

### CLIMATIC CHARACTERISTICS:

<b>Temperature Range:</b>	-55° C to +125° C
---------------------------	-------------------

### MECHANICAL CHARACTERISTICS:

<b>Fixed Contacts:</b>	Size 22 contact. Male contact — 0.030 inch (0.76mm) diameter. Female contact — rugged open entry design.
<b>Contact Retention in Insulator:</b>	7 lbs. (31 N).
<b>Contact Terminations:</b>	Printed board mount with 90° terminations supported in footprint pattern by a plastic cross bar. Termination diameter 0.020 inch (0.51mm).
<b>Shells:</b>	Male shells may be dimpled for EMI/ESD ground paths.
<b>Polarization:</b>	Trapezoidally shaped shells and polarized jackscrews.
<b>Mounting Bracket Riveted to Connector:</b>	Riveted fasteners with 0.120 inch (3.05mm) diameter clearance hole, 4-40 threads, or 4-40 threads with nylon lock insert.
<b>Mounting to Printed Board:</b>	Rapid installation push-on fasteners.
<b>Locking Systems:</b>	Jackscrews and vibration locking systems for either front or rear panel mounted connectors.
<b>Mechanical Operations:</b>	500 operations minimum per IEC 512-5.

CONTACT VARIANTS

FACE VIEW OF MALE OR REAR VIEW OF FEMALE

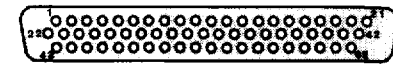
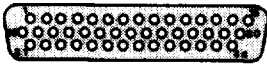
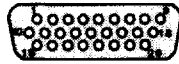
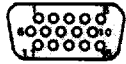
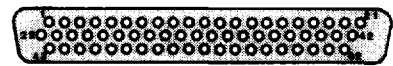
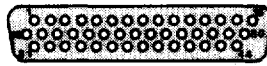
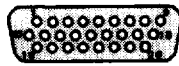
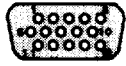

DD15/15

DD26/26

DD44/44

DD62/62

STANDARD SHELL ASSEMBLY

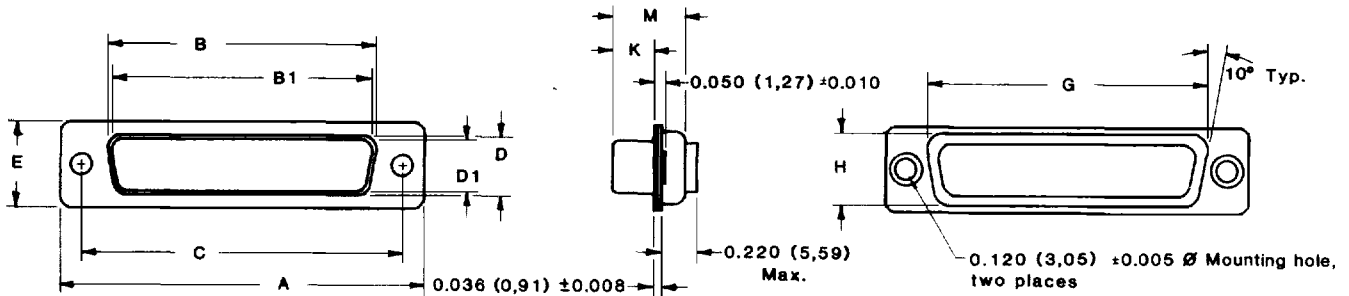

CONNECTOR VARIANT SIZES	A ± 0.015	B ± 0.005	B1 ± 0.005	C ± 0.005	D ± 0.005	D1 ± 0.005	E ± 0.015	G ± 0.010	H ± 0.010	K ± 0.005	M ± 0.010
15M/15M	1.213 (30,81)		0.666 (16,92)	0.984 (24,99)		0.329 (8,36)	0.494 (12,55)	0.759 (19,28)	0.422 (10,72)	0.233 (5,92)	0.422 (10,72)
15F/15F	1.213 (30,81)	0.643 (16,33)		0.984 (24,99)	0.311 (7,90)		0.494 (12,55)	0.759 (19,28)	0.422 (10,72)	0.243 (6,17)	0.429 (10,90)
26M/26M	1.541 (39,14)		0.994 (25,25)	1.312 (33,32)		0.329 (8,36)	0.494 (12,55)	1.083 (27,51)	0.422 (10,72)	0.233 (5,92)	0.422 (10,72)
26F/26F	1.541 (39,14)	0.971 (24,66)		1.312 (33,32)	0.311 (7,90)		0.494 (12,55)	1.083 (27,51)	0.422 (10,72)	0.243 (6,17)	0.429 (10,90)
44M/44M	2.088 (53,04)		1.534 (38,96)	1.852 (47,04)		0.329 (8,36)	0.494 (12,55)	1.625 (41,28)	0.422 (10,72)	0.230 (5,84)	0.426 (10,82)
44F/44F	2.088 (53,04)	1.511 (38,38)		1.852 (47,04)	0.311 (7,90)		0.494 (12,55)	1.625 (41,28)	0.422 (10,72)	0.243 (6,17)	0.429 (10,90)
62M/62M	2.729 (69,32)		2.182 (55,42)	2.500 (63,50)		0.329 (8,36)	0.494 (12,55)	2.272 (57,71)	0.422 (10,72)	0.230 (5,84)	0.426 (10,82)
62F/62F	2.729 (69,32)	2.159 (54,84)		2.500 (63,50)	0.311 (7,90)		0.494 (12,55)	2.272 (57,71)	0.422 (10,72)	0.243 (6,17)	0.429 (10,90)

DIMENSIONS ARE IN INCHES (MILLIMETERS)  
ALL DIMENSIONS SUBJECT TO CHANGE



**90 PRINTED BOARD MOUNT CONNECTOR  
6 ROW CONNECTOR UNIT, 0.450 (11,43) CONTACT EXTENSION**

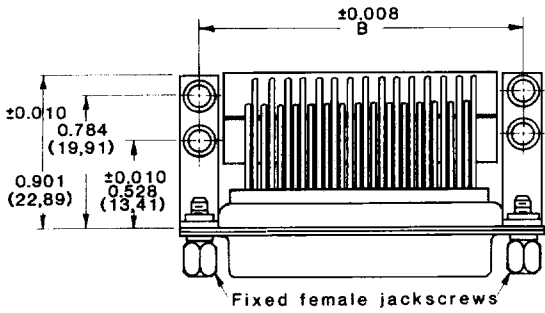

CONNECTOR VARIANT	NO. OF CONTACTS	A	B
15	30	1.204 (30,58)	0.984 (24,99)
26	52	1.532 (38,91)	1.312 (33,32)
44	88	2.072 (52,63)	1.852 (47,04)
62	124	2.720 (69,09)	2.500 (63,50)

CONNECTOR DESIGNATION	C	D	E
DDA	0.625 (15,88)	1.119 (28,42)	0.131 (3,33)
DDB	0.750 (19,05)	1.244 (31,60)	0.256 (6,50)
DDC	0.900 (22,86)	1.394 (35,41)	0.406 (10,31)

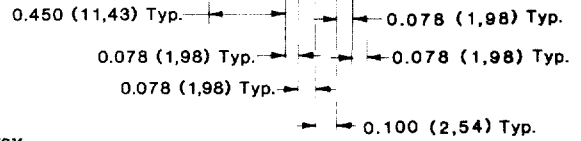
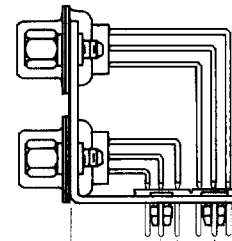
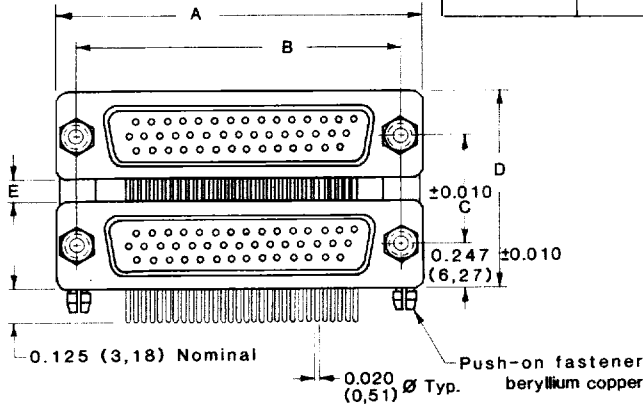

Typical part number: DDA44MN7T2/44MN7T2X

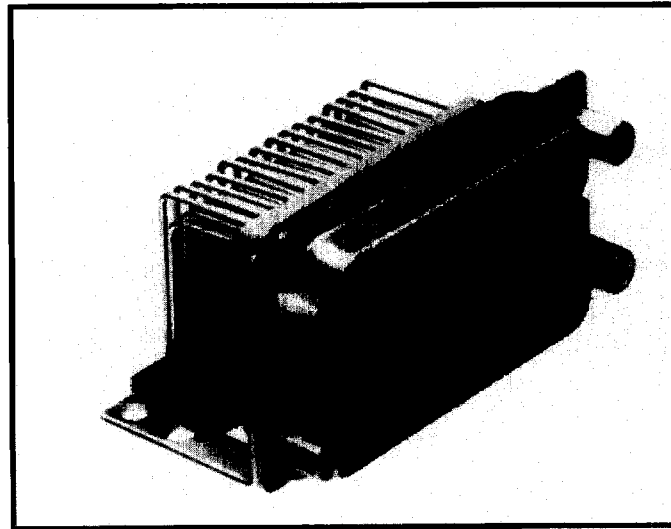

DDA44MR7T/44MR7T0

DIMENSIONS ARE IN INCHES (MILLIMETERS)  
ALL DIMENSIONS SUBJECT TO CHANGE

**PRINTED BOARD CONTACT HOLE PATTERN**

Mount connector with mating face positioned to follow direction of arrows.

**DD\*15 MALE OVER MALE CONNECTOR**

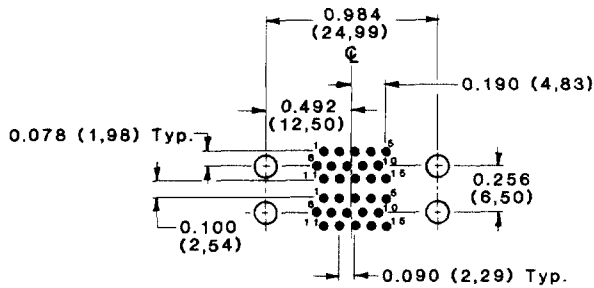

**DD\*15 FEMALE OVER FEMALE CONNECTOR**

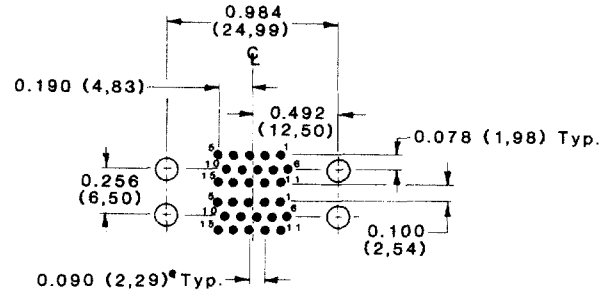

**DD\*26 MALE OVER MALE CONNECTOR**

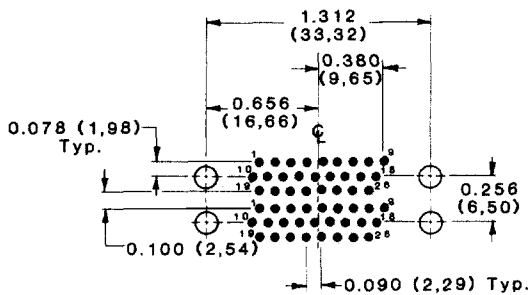

**DD\*26 FEMALE OVER FEMALE CONNECTOR**

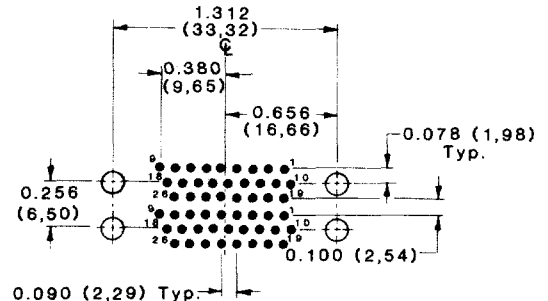

**DD\*44 MALE OVER MALE CONNECTOR**

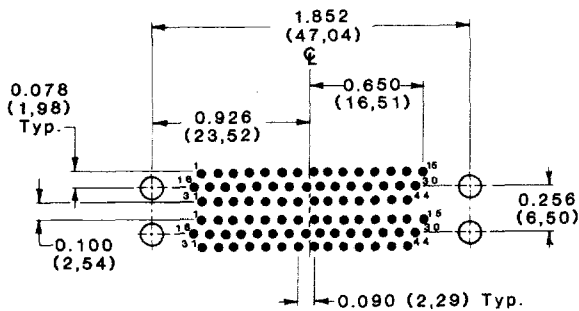

**DD\*44 FEMALE OVER FEMALE CONNECTOR**

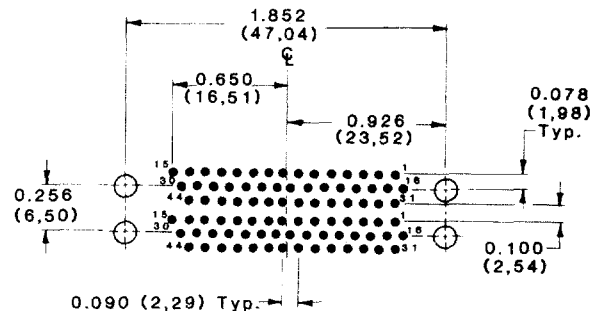

**DD\*62 MALE OVER MALE CONNECTOR**

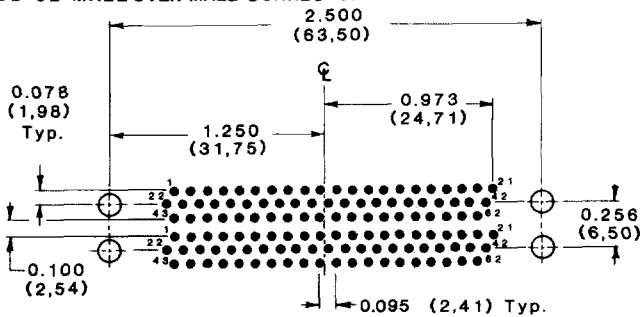

**DD\*62 FEMALE OVER FEMALE CONNECTOR**

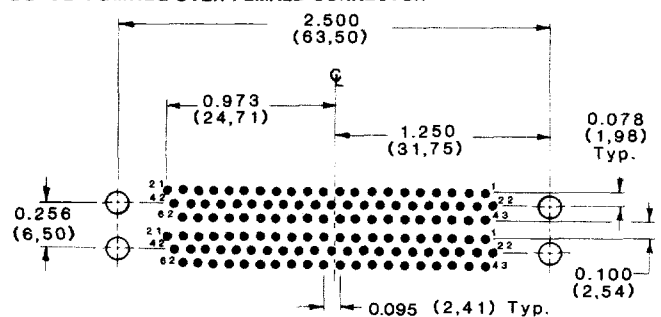

Mounting hole must move 0.020 (0,51) opposite direction of the arrow for use of unriveted mounting brackets with connectors.

Suggest 0.035 ±0.002 (0,89) Ø hole for contact termination positions.

Suggest 0.123 ±0.003 (3,12) Ø hole for mounting connector with push-on fasteners.

The \* signifies either a DDA, DDB or DDC connector type.

DIMENSIONS ARE IN INCHES (MILLIMETERS)  
ALL DIMENSIONS SUBJECT TO CHANGE



### ORDERING INFORMATION — CODE NUMBERING SYSTEM

Specify Complete Connector By Following Steps 1 Through 9  
Insert "0" When Step Is Not Used

STEP	1	2	3	4
Upper Connector	DDA	44	F	N6T
<b>STEP 1 Basic Series</b>				
DDA Series DDB Series DDC Series				
<b>STEP 2 DD Series Connector Variants</b>				
15, 26, 44, 62				
<b>STEP 3 Connector Gender</b>				
M — Male F — Female				
<b>STEP 4 Locking, Polarizing, Mounting and Push-On Fastener Systems</b>				
0 — None				
R2 — Bracket, Mounting, 90° Metal, Swaged to Connector with 4-40 Thread Fixed Female Jackscrews with Cross Bar				
R6 — Bracket, Mounting, 90° Metal, Swaged to Connector with 0.120 (3.05) Ø Mounting Hole with Cross Bar				
R7 — Bracket, Mounting, 90° Metal, Swaged to Connector with 4-40 Threads with Cross Bar				
R8 — Bracket, Mounting, 90° Metal, Swaged to Connector with 4-40 Locknut with Cross Bar				
N2 — Bracket, Mounting, 90° Metal, Swaged to Connector with 4-40 Thread Fixed Female Jackscrews with Cross Bar and Push-on Fastener				
N6 — Bracket, Mounting, 90° Metal, Swaged to Connector with 0.120 (3.05) Ø Mounting Hole with Cross Bar with Push-on Fastener				
N7 — Bracket, Mounting, 90° Metal, Swaged to Connector with 4-40 Threads with Cross Bar and with Push-on Fastener				
N8 — Bracket, Mounting, 90° Metal, Swaged to Connector with 4-40 Locknut with Cross Bar and with Push-on Fastener				
V3 — Lock Tab, connector front panel mounted				
V5 — Lock Tab, connector rear panel mounted				
T — Fixed Female Jackscrews				
T2 — Fixed Female Jackscrews				
T6 — Fixed Male and Female Polarized				

5	6	7
44	F	N6T

8	9
X	

Lower Connector

**STEP 9 Special Options**  
Consult Sales Department

**STEP 8 Shell Options**

0	— Zinc, Plated with Dichromate Seal
X	— Tin Plated
Z	— Tin Plated and Dimpled

Options are the same as for Upper Connector Steps 2, 3, and 4.