

### General Description

Battery Packs and Battery-powered portable equipment applications. It's mainly suitable for use as a load switch in battery powered applications and protection in battery packs.

### FEATURES

- $V_{DSS} = -20V$ ,  $I_D = -5.8A$ .
- Drain-Source ON Resistance.
- $R_{DS(ON)} = 36m\ \Omega$  (Max.) @  $V_{GS} = -4.5V$ .
- $R_{DS(ON)} = 62m\ \Omega$  (Max.) @  $V_{GS} = -2.5V$ .

### MAXIMUM RATING (Ta=25 °C)

CHARACTERISTIC		SYMBOL	RATING	UNIT
Drain-Source Voltage		$V_{DSS}$	-20	V
Gate-Source Voltage		$V_{GSS}$	$\pm 12$	V
Drain Current	DC	$I_D^*$	-5.8	A
	Pulsed (Note2)	$I_{DP}$	-24	
Drain Power Dissipation	Ta=25 °C	$P_D^*$	2.0	W
	Ta=100 °C		0.8	
Maximum Junction Temperature		$T_j$	150	°C
Storage Temperature Range		$T_{stg}$	-55 ~ 150	°C
Thermal Resistance, Junction to Ambient		$R_{thJA}^*$	62.5	°C/W

\* : Surface Mounted on 1" × 1" Board, t ≤ 10sec.

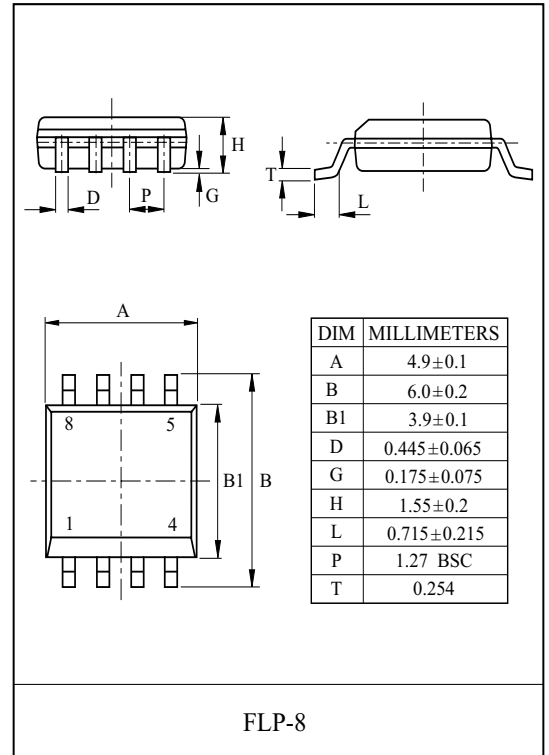

### PIN CONNECTION (TOP VIEW)

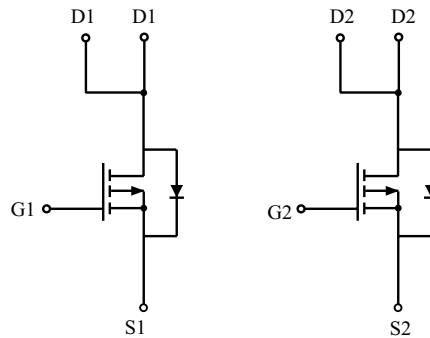
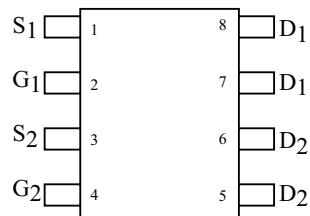

# KMA5D8DP20Q

## ELECTRICAL CHARACTERISTICS (Ta=25°C)

CHARACTERISTIC	SYMBOL	TEST CONDITION	MIN.	TYP.	MAX.	UNIT
<b>Static</b>						
Drain-Source Breakdown Voltage	$BV_{DSS}$	$I_D=-250\mu A, V_{GS}=0V,$	-20	-	-	V
Drain Cut-off Current	$I_{DSS}$	$V_{DS}=-20V, V_{GS}=0V,$	-	-	-1	$\mu A$
Gate Threshold Voltage	$V_{th}$	$V_{DS}=V_{GS}, I_D=-250\mu A$	-0.6	-	-	V
Gate Leakage Current	$I_{GSS}$	$V_{GS}=\pm 12V, V_{DS}=0V$	-	-	$\pm 100$	nA
Drain-Source ON Resistance	$R_{DS(ON)}$	$V_{GS}=-4.5V, I_D=-5.8A$ (Note 2)	-	29	36	m $\Omega$
		$V_{GS}=-2.5V, I_D=-4.4A$ (Note 2)	-	49	62	
<b>Dynamic</b> (Note 3)						
Total Gate Charge	$Q_g$	$V_{DS}=-10V, I_D=-5.8A$ $V_{GS}=-4.5V$ (Fig.1)	-	14	-	nC
Gate-Source Charge	$Q_{gs}$		-	2.3	-	
Gate-Drain Charge	$Q_{gd}$		-	5.5	-	
Turn-on Delay time	$t_{d(on)}$	$V_{DD}=-10V,$ $R_L=1.69\Omega, R_G=6\Omega$ (Fig.2)	-	10	-	ns
Turn-on Rise time	$t_r$		-	37	-	
Turn-off Delay time	$t_{d(off)}$		-	36	-	
Turn-off Fall time	$t_f$		-	52	-	
<b>Source-Drain Diode Ratings</b>						
Continuous Source Current	$I_S$	$V_{GS} < V_{th}$ (Note 1)	-	-	-1.5	A
Diode Forward Voltage	$V_{SD}$	$I_S=-5.8A, V_{GS}=0V$ (Note 2)	-	-	-1.5	V

Note 1) Based on thermal dissipation from junction to ambient while mounted on a 1" × 1" PCB Board.

Note 2) Pulse test : Pulse width  $\leq 300\mu s$ .

Note 3) Guaranteed by design, not subject to production testing.

# KMA5D8DP20Q

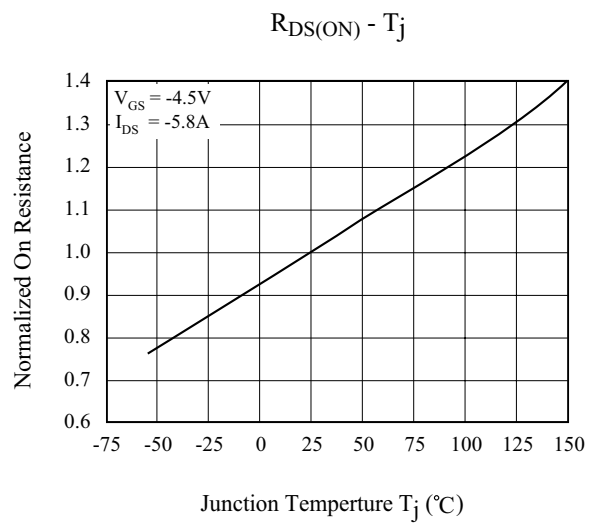
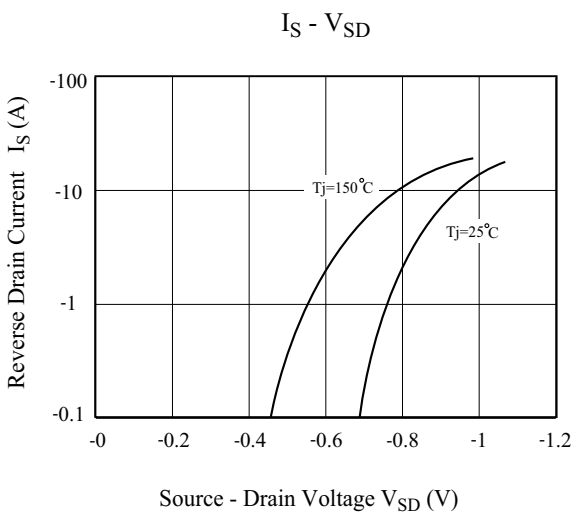
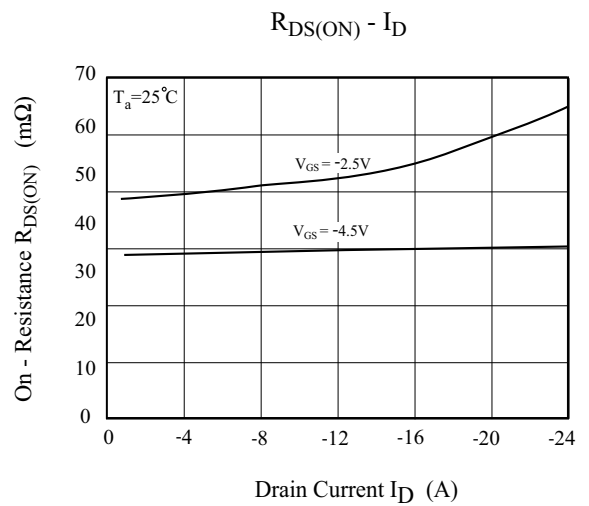
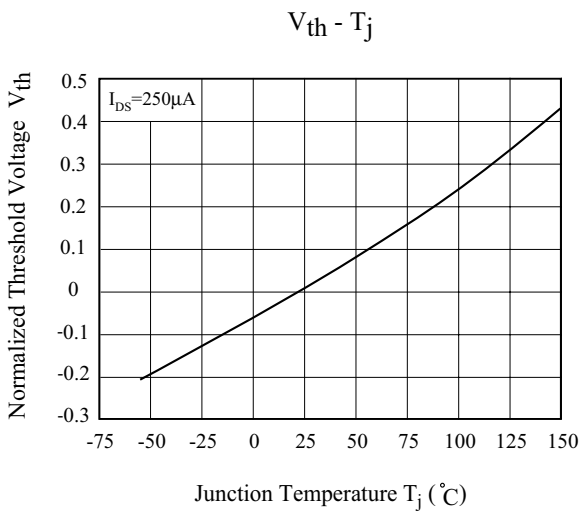
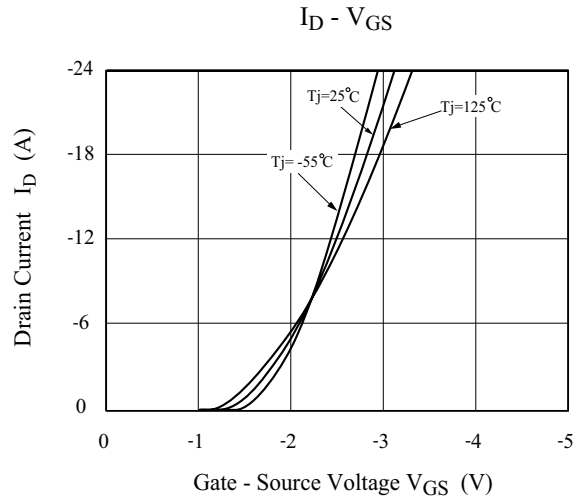
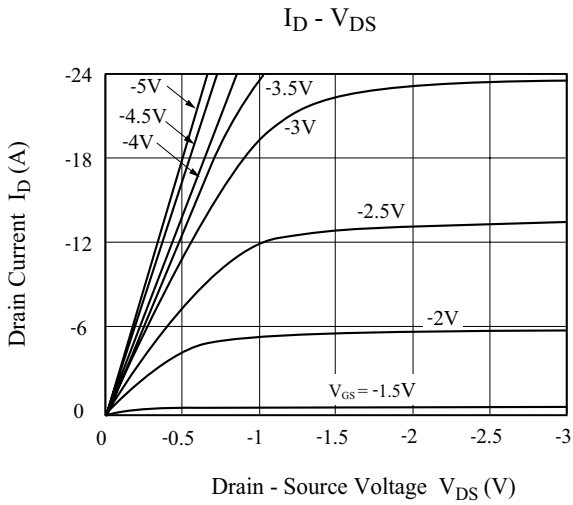

# KMA5D8DP20Q

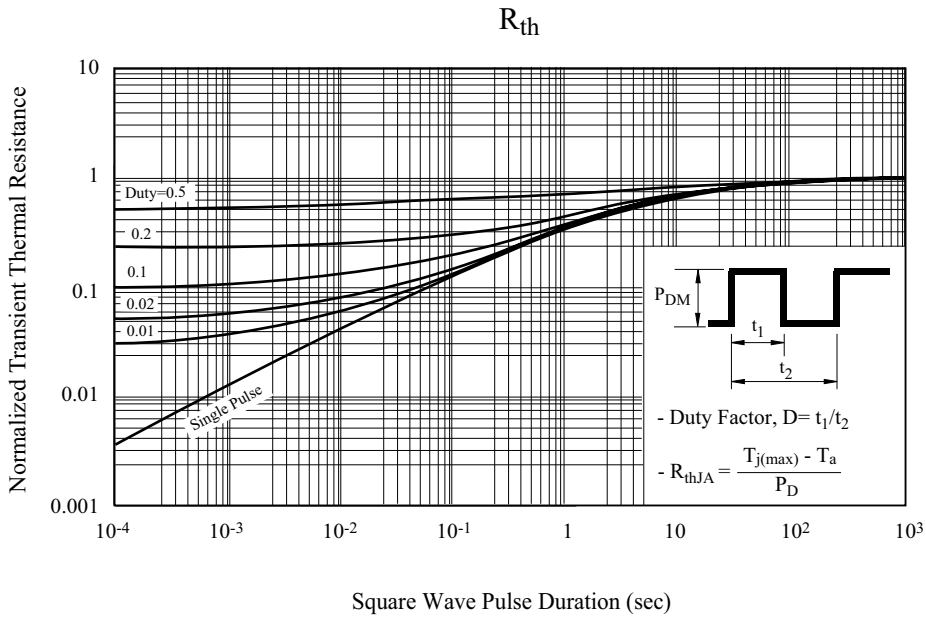
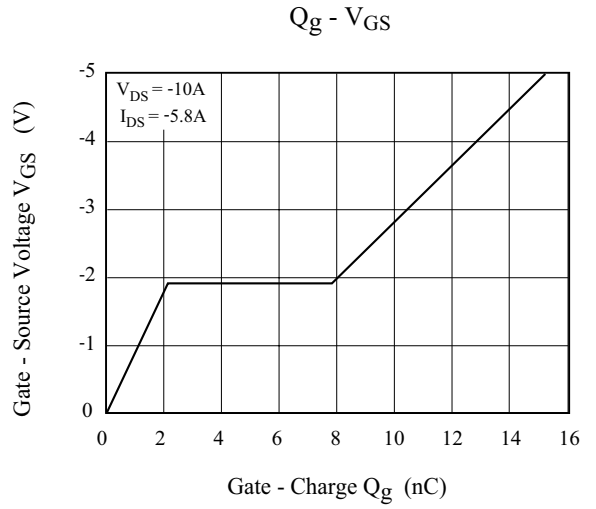
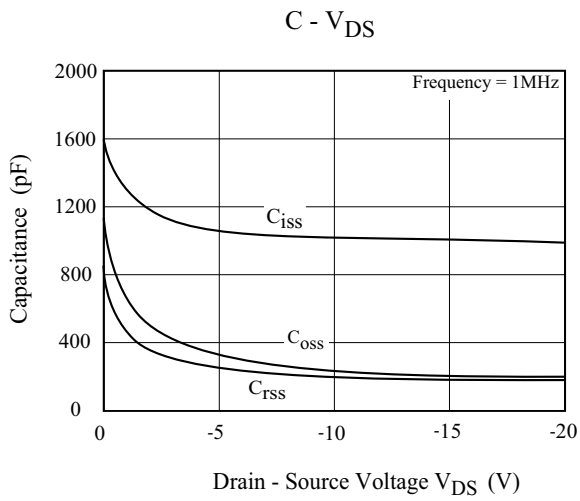

# KMA5D8DP20Q

Fig. 1 Gate Charge

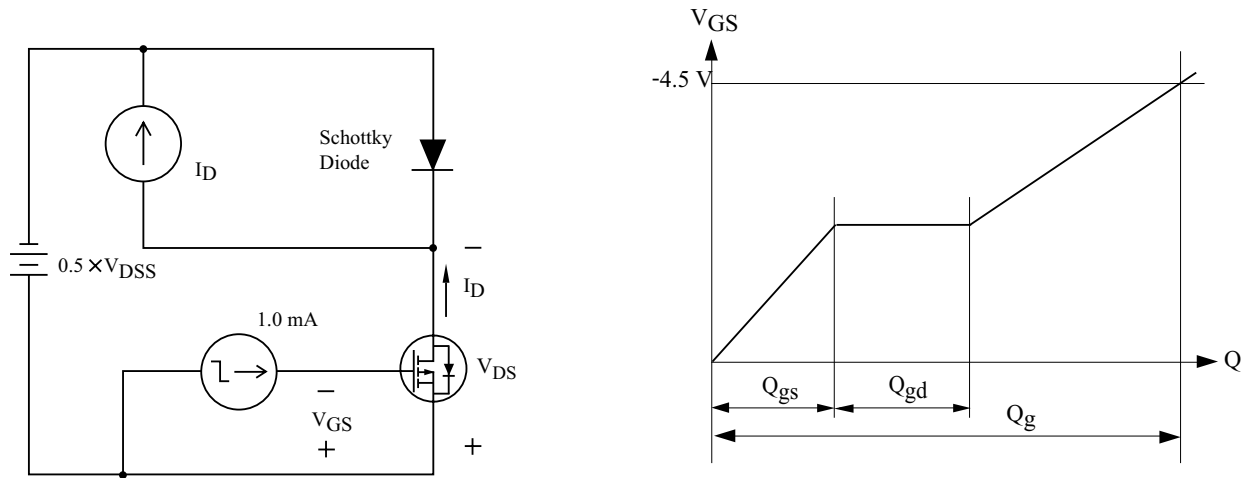

Fig. 2 Resistive Load Switching

