

ABSOLUTE PRESSURE TRANSMITTER

DATA SHEET

FKA...4

The FCX-A II absolute pressure transmitter accurately measures absolute pressure and transmits a proportional 4 to 20mA signal.

The transmitter utilizes a unique micromachined capacitance silicon sensor with state-of-the-art microprocessor technology to provide exceptional performance and functionality.

FEATURES

1. High accuracy

0.2% accuracy for all calibrated spans is a standard feature for all AP models covering 1.6kPa {0.016bar} range to 3000kPa {30bar} high pressure range. 0.1% accuracy is available as option. Fuji's micro-capacitance silicon sensor assures this accuracy for all suppressed calibration ranges without additional adjustment.

2. Minimum environmental influence

The "Advanced Floating Cell" design which protects the pressure sensor against changes in temperature, and overpressure substantially reduces total measurement error in actual field applications.

3. Fuji/HART® bilingual communications protocol and FOUNDATION™ fieldbus and Profibus™ compatibility

FCX-AII series transmitter offers bilingual communications to speak both Fuji proprietary protocol and HART®. Any HART® compatible devices can communicate with FCX-AII. Further, by upgrading electronics FOUNDATION™ fieldbus and Profibus™ are also available.

4. Application flexibility

Various options that render the FCX-A II suitable for almost any process applications include:

- Analog indicator at either the electronics side or terminal side
- Full range of hazardous area approvals
- Built-in RFI filter and lightning arrester
- 5-digit LCD meter with engineering unit
- Stainless steel electronics housing
- Wide selection of materials

5. Burnout current flexibility (Under Scale: 3.2 to 3.8mA, Over Scale: 20.8 to 21.6mA)

Burnout signal level is adjustable using Model FXW Hand Held Communicator (HHC) to comply with NAMUR NE43.

6. Dry calibration without reference pressure

Thanks to the best combination of unique construction of mechanical parts (Sensor unit) and high performance electronics circuit (Electronics unit), reliability of dry calibration without reference pressure is at equal level as wet calibration.



SPECIFICATIONS

Functional specifications

Service: Liquid, gas, or vapour
Span, range, and overrange limit:

Type	Span limit [kPa abs] [bar abs]		Range limit [kPa abs] [bar abs]	Overrange limit [MPa] [bar]
	Min.	Max.		
FKA□01	1.6 {0.016}	16 {0.16}	0 to +16 {0 to +0.16}	0.5 {5}
FKA□02	1.6 {0.016}	130 {1.3}	0 to +130 {0 to +1.3}	0.5 {5}
FKA□03	5 {0.05}	500 {5}	0 to +500 {0 to +5}	1.5 {15}
FKA□04	30 {0.3}	3000 {30}	0 to +3000 {0 to +30}	9 {90}

Remark: To minimize environmental influence, span should be greater than 1/40 of the max. span in most applications.

- The maximum span of each sensor can be converted to different units using factors as below.

$$1 \text{ MPa abs} = 10^3 \text{ kPa abs} = 10 \text{ bar abs} = 10.19716 \text{ kgf/cm}^2 \text{ abs} = 145.0377 \text{ psi abs}$$

$$1 \text{ kPa abs} = 10 \text{ mbar abs} = 101.9716 \text{ mmH}_2\text{O abs} = 4.01463 \text{ inH}_2\text{O abs} = 7.50062 \text{ mmHg abs}$$

Output signal: 4 to 20mA DC with digital signal superimposed on the 4 to 20mA signal.

Power supply: Transmitter operates on 10.5V to 45V DC at transmitter terminals.
 10.5V to 32V DC for the units with optional arrester.

Load limitations: see figure below

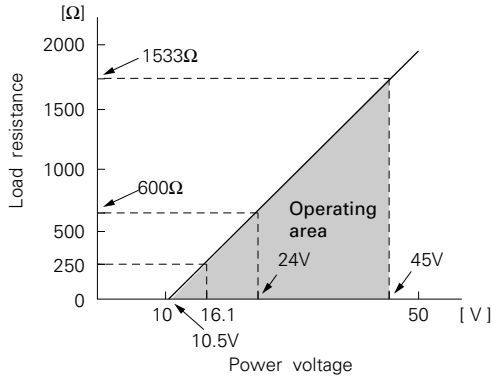

Note: For communication with HHC⁽¹⁾ (Model: FXW), min. of 250Ω is required.

Hazardous locations:

Authorities	Flameproof
ATEX	Ex II 2 GD EEx d IIC T6 IP66/67 T85°C Tamb = -40°C to +65°C EEx d IIC T5 IP66/67 T100°C Tamb = -40°C to +85°C
Factory Mutual	Class I Div.1 Groups B, C, D T6 Type 4X Class II III Div.1 Groups E, F, G T6 Type 4X Tamb max = +60°C
CSA	Class I Div.1 Groups C, D Class II Div.1 Groups E, F, G Class III Div.1 Note) "Seal Not Required" enclosure is allowed.
TIIS	Ex do IIB+H ₂ T4 Tamb max = +55°C Maximum process temp. = +120°C
IECEX Scheme /SAA	Ex d IIC T5 IP66/67 pending Tamb = -40°C to +85°C Ex d IIC T6 IP66/67 pending Tamb = -40°C to +65°C

Authorities	Intrinsic safety										
ATEX	Ex II 1 GD EEx ia IIC T5 Tamb = -40°C to +40°C EEx ia IIC T4 Tamb = -40°C to +80°C Entity Parameters: Ui=28V, li=93.3mA, Pi=0.66W, Ci=27nF (Without Arrester), Ci=34.2nF (With Arrester), Li=1.134mH										
Factory Mutual	Class I II III Div.1 Groups A, B, C, D, E, F, G T4 Entity Type 4X <table border="1"> <thead> <tr> <th>Model code 9th digit</th> <th>Tamb</th> </tr> </thead> <tbody> <tr> <td>A,B,D</td> <td>-40°C to +85°C</td> </tr> <tr> <td>L,P,1,2</td> <td>-20°C to +80°C</td> </tr> <tr> <td>Q,S,4,5</td> <td>-20°C to +60°C</td> </tr> <tr> <td>E,F,H</td> <td>-40°C to +60°C</td> </tr> </tbody> </table> Entity Parameters: Vmax=42.4V, Imax=113mA, Pi=1W, Ci=34.2nF, Li=1.134mH	Model code 9th digit	Tamb	A,B,D	-40°C to +85°C	L,P,1,2	-20°C to +80°C	Q,S,4,5	-20°C to +60°C	E,F,H	-40°C to +60°C
Model code 9th digit	Tamb										
A,B,D	-40°C to +85°C										
L,P,1,2	-20°C to +80°C										
Q,S,4,5	-20°C to +60°C										
E,F,H	-40°C to +60°C										
CSA	Class I Div.1 Groups A, B, C, D Class II Div.1 Groups E, F, G Class III Div.1 Temp Code T4 Tamb max = +40°C Temp Code T3C Tamb max = +85°C Entity Parameters: Vmax=28V, Imax=93mA, Ci=27nF (Without Arrester), Ci=34.2nF (With Arrester), Li=1.4mH										
TIIS	Ex ia IIC T4 Tamb max = +60°C Entity Parameters: Ui=28V, li=94.3mA, Pi=0.66W, Ci=32.6nF, Li=1.134mH										
IECEX Scheme /SAA	Ex ia IIC T4 IP66/67 Tamb = -40°C to +70°C Ex ia IIC T5 IP66/67 Tamb = -40°C to +50°C Entity Parameters: Ui=28V, li=93.3mA, Pi=0.66W, Ci=0.033μF, Li=1.034mH										

Authorities	Type n Nonincendive										
ATEX	Ex II 3 GD EEx nL IIC T5 Tamb = -40°C to +40°C EEx nL IIC T4 Tamb = -40°C to +80°C Specific Parameters: Model without arrester: Ui=42.4V, li=113mA, Pi=1W, Ci=27nF, Li=1.134mH Model with arrester: Ui=32V, li=113mA, Pi=1W, Ci=34.2nF, Li=1.134mH EEx nAL IIC T5 Tamb = -40°C to +40°C EEx nAL IIC T4 Tamb = -40°C to +80°C Specific Parameters: Model without arrester: Umax=42.4V, lmax=113mA, Pmax=1W Model with arrester: Umax=32V, lmax=113mA, Pmax=1W										
Factory Mutual	Class I II III Div.2 Groups A, B, C, D, F, G T4 Entity Type 4X <table border="1"> <thead> <tr> <th>Model code 9th digit</th> <th>Tamb</th> </tr> </thead> <tbody> <tr> <td>A,B,D</td> <td>-40°C to +85°C</td> </tr> <tr> <td>L,P,1,2</td> <td>-20°C to +80°C</td> </tr> <tr> <td>Q,S,4,5</td> <td>-20°C to +60°C</td> </tr> <tr> <td>E,F,H</td> <td>-40°C to +60°C</td> </tr> </tbody> </table>	Model code 9th digit	Tamb	A,B,D	-40°C to +85°C	L,P,1,2	-20°C to +80°C	Q,S,4,5	-20°C to +60°C	E,F,H	-40°C to +60°C
Model code 9th digit	Tamb										
A,B,D	-40°C to +85°C										
L,P,1,2	-20°C to +80°C										
Q,S,4,5	-20°C to +60°C										
E,F,H	-40°C to +60°C										
CSA	Class I Div.2 Groups A, B, C, D Class II Div.2 Groups E, F, G Class III Div.2 Temp Code T4 Tamb max = +40°C Temp Code T3C Tamb max = +85°C Entity Parameters: Vmax=28V, Ci=27nF (Without Arrester), Ci=34.2nF (With Arrester), Li=1.4mH										
TIIS	-										
IECEX Scheme /SAA	-										

Zero/span adjustment:

Zero and span are adjustable from the HHC⁽¹⁾. Zero and span are also adjustable externally from the adjustment screw (span adjustment is not available with 9th digit code "L, P, Q, S").

Damping:

Adjustable from HHC or local adjustment unit with LCD display. The time constant is adjustable between 0.12 to 32 seconds.

Zero elevation/suppression:

Zero can be elevated within the specified range limit of each sensor model.

Normal/reverse action:

Selectable from HHC⁽¹⁾.

Indication:

Analog indicator or 5-digit LCD meter, as specified.

Burnout direction: Selectable from HHC⁽¹⁾

If self-diagnostic detect transmitter failure, the analog signal will be driven to either "Output Hold", "Output Overscale" or "Output Underscale" modes.

"Output Hold":

Output signal is hold as the value just before failure happens.

"Output Overscale":

Adjustable within the range 20.8mA to 21.6mA from HHC⁽¹⁾

"Output Underscale":

Adjustable within the range 3.2mA to 3.8mA from HHC⁽¹⁾

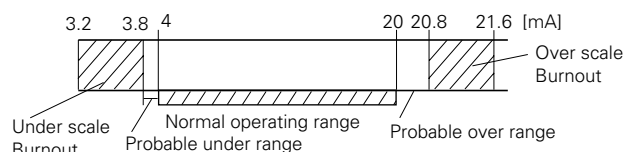

Loop-check output:

Transmitter can be configured to provide constant signal 3.8mA through 21.6mA by HHC⁽¹⁾.

Temperature limit:

Ambient: -40 to +85°C
 (-20 to +80°C for LCD indicator)
 (-40 to +60°C for arrester option)
 For explosionproof units (flameproof or intrinsic safety), ambient temperature must be within the limits specified by each standard.

Process: -40 to +85°C for silicone fill sensor

Storage: -40 to +90°C

Humidity limit: 0 to 100% RH

Communication: With HHC⁽¹⁾ (Model FXW, consult Data Sheet No. EDS8-47), following information can be remotely displayed or reconfigured.

Note: HHC's version must be more than 6.0 (or FXW □□□□1-□3), for FCX-A II.

Items	Display	Set
Tag No.	✓	✓
Model No.	✓	✓
Serial No.	✓	—
Engineering unit	✓	✓
Range limit	✓	—
Measuring range	✓	✓
Damping	✓	✓
Output mode	✓	—
Burnout direction	✓	✓
Calibration	✓	✓
Output adjust	—	✓
Data	✓	—
Self diagnoses	✓	—
Printer	—	—
External switch lock	✓	✓
Transmitter display	✓	✓
Linearize	✓	✓
Rerange	✓	✓

EMC Conformity: EN61326 CE

(Note) (1) HHC: Hand Held Communicator

Performance specifications

Reference conditions, silicone oil fill, 316SS isolating diaphragms, 4 to 20mA analog output in linear mode.

Accuracy rating: (including linearity, hysteresis, and repeatability).

(Standard)

For spans greater than 1/10 of URL: ±0.2% of span

For spans below 1/10 of URL:

$$\pm \left(0.1 + 0.1 \frac{0.1 \times \text{URL}}{\text{Span}} \right) \% \text{ of span}$$

(Option) (code: 21th digit H)

(Not available for Max span 16kPa abs, 130kPa abs)

For spans greater than 1/10 of URL: ±0.1% of span

For spans below 1/10 of URL:

$$\pm \left(0.05 + 0.05 \frac{0.1 \times \text{URL}}{\text{Span}} \right) \% \text{ of span}$$

Stability: ±0.2% of upper range limit (URL) for 3 years.

Temperature effect:

Effect per 28°C change between the limits of -40°C and +85°C

$$\text{Zero shift: } \pm \left(0.125 + 0.1 \frac{\text{URL}}{\text{Span}} \right) \%$$

$$\text{Total effect: } \pm \left(0.15 + 0.1 \frac{\text{URL}}{\text{Span}} \right) \%$$

Overrange effect: Zero shift; ±0.2% of URL for any overrange to maximum limit

Supply voltage effect:

Less than 0.005% of calibrated span per 1V

RFI effect: Less than 0.2% of URL for the frequencies of 20 to 1000MHz and field strength 30V/m when electronics covers on.

(Classification: 2-abc: 0.2% span per SAMA PMC 33.1)

Update period: 120 msec *)

Step response: Time constant: 0.2 s*)

Dead time: 0.2 s*)

(without electrical damping)

*) Faster response is available as option (maximum update rate: 25 times per second).

Mounting position effect:

Zero shift, less than 0.1kPa{1mbar} for a 10° tilt in any plane.

No effect on span. This error can be corrected by adjusting zero.

Dielectric strength:

500V AC, 50/60Hz 1 min., between circuit and earth.

Insulation resistance:

More than 100MΩ at 500V DC.

Turn-on time: 4 sec

Internal resistance for external field indicator:

12Ω or less

Physical specifications

Electrical connections:

G1/2, 1/2-14NPT, Pg13.5, or M20 x 1.5 conduit, as specified.

1-port (standard) or 2-port with each conduit, as specified.

Process connections:

1/4-18 NPT or Rc1/4 on 54mm centers, as specified.

Process-wetted parts material:

Material code (7th digit in "Code symbols")	Process cover	Diaphragm	Wetted sensor body	Vent/drain
V	316 stainless steel (*)	316L stainless steel	316 stainless steel	316/316L stainless steel
H	316 stainless steel (*)	Hastelloy-C	Hastelloy-C lining	316/316L stainless steel
M	316 stainless steel (*)	Monel	Monel lining	316/316L stainless steel
T	316 stainless steel (*)	Tantalum	Tantalum lining	316/316L stainless steel

Note: (*) SCS14A per JIS G 5121 (equivalent CF8M per ASTM A351/A351M)

Remarks: Sensor O-rings: Viton

Availability of above material design depends on ranges. Refer to "Code symbols".

Non-wetted parts material:

Electronics housing: Low copper die-cast aluminum alloy finished with epoxy/polyurethane double coating (standard), or 316 stainless steel (SCS14A per JIS G5121), as specified.

Bolts and nut: Cr-Mo alloy (standard) or 304 stainless steel

Fill fluid: Silicone oil

Mounting bracket: 304 stainless steel.

Environmental protection:

IEC IP67 and NEMA 6/6P

Mounting:

On 60.5mm (JIS 50A) pipe using mounting bracket, direct wall mounting, or direct process mounting.

Mass{weight}:

Transmitter approximately 3.4kg without options.

Add; 0.5kg for mounting bracket

0.8kg for indicator option

4.5kg for stainless steel housing option

Optional features

- Indicator:** A plug-in analog indicator (2.5% accuracy) can be housed in the electronics compartment or in the terminal box of the housing. An optional 5-digit LCD meter with engineering unit is also available.
- Local adjustment unit with LCD display:** An optional 5-digit LCD meter with Zero/ Span adjustment function, loop-check function and damping adjustment function, is available.
- Arrester:** A built-in arrester protects the electronics from lightning surges.
Lightning surge immunity:
4kV (1.2 × 50µs)
- Degreasing:** Process-wetted parts are cleaned, but the fill fluid is standard silicone oil. Not for use on oxygen or chlorine measurement.
- NACE specification:** Metallic materials for all pressure boundary parts comply with NACE MR-01-75. 304 stainless steel bolts and nuts, ASTM B7M or L7M bolts and 2HM nuts (Class II) are available.
- Optional tagplate:** An extra stainless steel tag for customer tag data is wired to the transmitter.
- Coating of cell:** Cell's surface is finished with epoxy/polyurethane double coating. Specify if environment is extremely corrosive.

ACCESSORIES

- Oval flanges:** (Model FFP, refer to Data Sheet No. EDS6-10)
Converts process connection to 1/2-14 NPT or to Rc1/2; in carbon steel or in 316 stainless steel.
- Hand held communicator:** (Model FXW, refer to Data Sheet No.EDS 8-47)
- Z/S board:** Parts No.=ZZPFCX4-A070
When Z/S board is mounted on the FCX-AII amplifier unit, external adjustment screw will be available for zero and span adjustment.

CODE SYMBOLS

Digit	Description	Note	Digit No. of code																			
			1	2	3	4	5	6	7	8	9	10	11	12	13	14	15	21				
4	<Connections>		F	K	A	0	4															
	Process connection	Oval flange screw	Conduit connection																			
	Rc1/4	7/16-20UNF	G1/2 (×1)	Combination with 12th digit code "C, E, P, Q" are not available.																		
	1/4-18NPT	7/16-20UNF	1/2-14NPT (×1)	A																		
	1/4-18NPT	M10	Pg 13.5 (×1)	B																		
	1/4-18NPT	M10	M20×1.5 (×1)	C																		
	1/4-18NPT	7/16-20UNF	Pg 13.5 (×1)	D																		
	Rc1/4	7/16-20UNF	G1/2 (×2)	E																		
	1/4-18NPT	7/16-20UNF	1/2-14NPT (×2)	S																		
	1/4-18NPT	M10	Pg 13.5 (×2)	T																		
1/4-18NPT	M10	M20×1.5 (×2)	V																			
1/4-18NPT	7/16-20UNF	Pg 13.5 (×2)	W																			
1/4-18NPT	7/16-20UNF	Pg 13.5 (×2)	X																			
6, 7					Note1																	
	Span limit [kPa abs] [bar abs](*1)	Process cover	Diaphragm	Wetted cell body																		
	1.6...16 {0.016...0.16}	316 stainless steel	316L stainless steel	316 stainless steel		1V																
		316 stainless steel	Hast. C	Hast. C lining		1H																
		316 stainless steel	Monel	Monel lining		1M																
	1.6...130 {0.016...1.3}	316 stainless steel	316L stainless steel	316 stainless steel		2V																
		316 stainless steel	Hast. C	Hast. C lining		2H																
		316 stainless steel	Monel	Monel lining		2M																
	5...500 {0.05...5}	316 stainless steel	316L stainless steel	316 stainless steel		2T																
		316 stainless steel	Hast. C	Hast. C lining		3V																
316 stainless steel		Monel	Monel lining	3H																		
30...3000 {0.3...30}	316 stainless steel	316L stainless steel	316 stainless steel	3M																		
	316 stainless steel	Hast. C	Hast. C lining	3T																		
	316 stainless steel	Monel	Monel lining	4V																		
9	<Indicator and arrester>																					
	<u>Indicator</u>		<u>Arrester</u>																			
	None	None		Z/S board attached.	A																	
	Analog, 0 to 100% linear scale	None			B																	
	Analog, custom scale	None			D																	
	None	Yes		Z/S board attached.	E																	
	Analog, 0 to 100% linear scale	Yes			F																	
	Analog, custom scale	Yes			H																	
	Digital, 0 to 100%	None		Z/S board attached.	L																	
	Digital, custom scale	None			P																	
Digital, 0 to 100%	Yes		Q																			
Digital, custom scale	Yes		Z/S board attached.	S																		
Digital, 0 to 100%	None			1																		
(Local adjustment unit with LCD display)	None			2																		
Digital, custom scale	None		Z/S board attached.	4																		
(Local adjustment unit with LCD display)	Yes			5																		
Digital, 0 to 100%	Yes			Z/S board attached.																		
(Local adjustment unit with LCD display)	Yes																					
Digital, custom scale	Yes																					
(Local adjustment unit with LCD display)	Yes																					
10	<Approvals for hazardous locations>																					
	None (for ordinary locations)				A																	
	TIIS, Flameproof (Conduit seal)		(Available for 4th digit code "A", "S")		B																	
	TIIS, Flameproof (Cable gland seal)		(Available for 4th digit code "A", "S")		C																	
	FM, Flameproof (or explosionproof)		(Available for 4th digit code "B", "T")		D																	
	CSA, Flameproof (or explosionproof)		(Available for 4th digit code "B", "T")		E																	
	ATEX, Flameproof				X																	
	IECEx Scheme/SAA, Flameproof (Approval pending)				R																	
	TIIS, Intrinsic safety				G																	
	FM, Intrinsic safety and nonincendive				H																	
CSA, Intrinsic safety and nonincendive				J																		
ATEX, Intrinsic safety				K																		
ATEX, Type n				P																		
IECEx Scheme/SAA, Intrinsic safety				T																		
FM, Combined of Flameproof and Intrinsic safety				V																		
11	<Vent/ drain and mounting bracket>																					
	Vent/drain	Mounting bracket																				
	Standard	None			A																	
	Standard	Yes, stainless steel			C																	
	Side	None			D																	
Side	Yes, stainless steel			F																		

Note1: (*1) 100: 1 turn down is possible, but should be used at a span greater than 1/40 of the maximum span for better performance.

Digit	Description	Note	1	2	3	4	5	6	7	8	9	10	11	12	13	14	15	21	Digit No. of code
12	<Options> <u>Extra SS tag plate</u> <u>Stainless steel elec. housing</u> <u>Coating of cell</u> None None None Yes None None None Yes None Yes Yes None ----- None None Yes Yes None Yes None Yes Yes Yes Yes Yes	Note2	F	K	A	0	4												
13	<Special applications and fill fluid> <u>Treatment</u> <u>Fill fluid</u> Standard Silicone oil Degreasing Silicone oil NACE specification Silicone oil (7th digit code "T" and 15th digit code "A", "B" are not available)																		
14	<Sensor O-ring> Viton																	A	
15	<Bolt/nut> (*3) Cr-Mo alloy hexagon socket head cap screw/carbon steel nut Cr-Mo alloy hexagon bolt/nut NACE bolt/nut (ASTM A193 B7M/A194 2HM) NACE bolt/nut (ASTM A320 L7M/A194 2HM) 304 stainless steel bolt/304 stainless steel nut	Note 3																	A B C D E
21	<Other options> (*4) High accuracy type Instruction manual attached Instruction manual unattached High accuracy type Instruction manual unattached	Note4																	H L T

Note2: (*2) Customer tag number can be engraved on standard stainless steel name plate. If extra tag plate is required, select "Yes".

Note3: (*3) In case of tropical use, select stainless bolts and nuts.

Note3: (*4) If other option is not necessary, 21st digit code is blank.

In case of 21st digit code is blank, instruction manual attached.

OUTLINE DIAGRAM (Unit:mm)

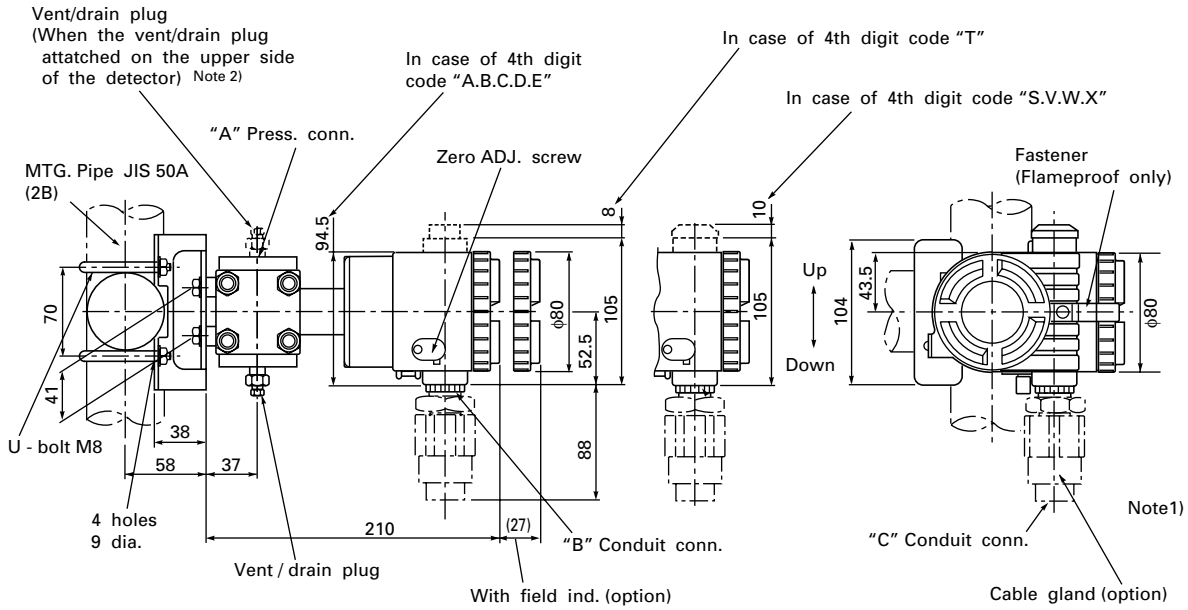

Detail "A"
(Press. conn.)

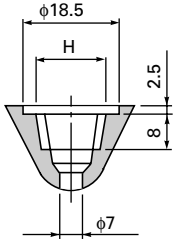

Detail "B"
(Conduit conn.)

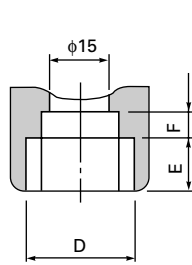

Detail "C"

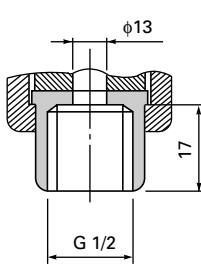

See Table 1

See Table 1

4th digit of the code symbols	Conduit conn.			Press. conn.	Oval flange screw
	D	E	F	H	
A, S	G1/2	17	8	Rc1/4	7/16-20UNF screw depth 15
B, T	1/2-14NPT	16	5	1/4-18NPT	7/16-20UNF screw depth 15
C, V	Pg13.5	8	4.5	1/4-18NPT	M10 screw depth 15
D, W	M20x1.5	16	5	1/4-18NPT	M10 screw depth 15
E, X	Pg13.5	8	4.5	1/4-18NPT	7/16-20UNF screw depth 15

Table 1

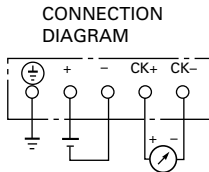
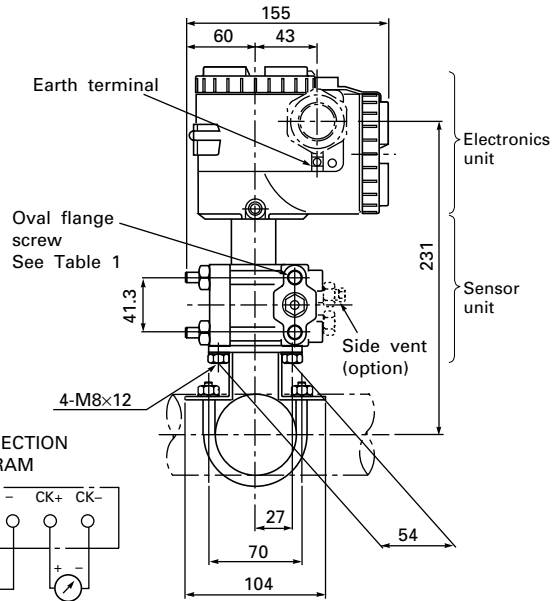

- Note 1) Cable gland is supplied in case of flameproof packing type. $\phi 11$ cable is suitable.
- Note 2) The pressure connector is located on the down side surface of the detector, when the vent/drainplug is attached on the upper side of the detector. (When the 21st digit of the code symbols : C, E or D).

The product conforms to the requirements of the Electromagnetic compatibility Directive 94/9/EC as detailed within the technical construction file number TN513035. The applicable standards used to demonstrate compliance are :

EMI (Emission) EN61326 : 1997
Class A (standard for Industrial Location)

Frequency range MHz	Limits	Reference standard
30 to 230	40dB (µV/m) quasi peak, measured at 10m distance	CISPR16-1 and CISPR16-2
230 to 1000	47dB (µV/m) quasi peak, measured at 10m distance	

EMI (Immunity) EN61326: 1997
Annex A (standard for Industrial Location)

Phenomenon	Test value	Basic standard	Performance criteria
Electrostatic discharge	4kV (Contact) 8kV (Air)	EN61000-4-2	B
Electromagnetic field	80 to 1000MHz 10V/m 80%AM (1kHz)	EN61000-4-3	A
Rated power frequency magnetic field	30A/m 50Hz	EN61000-4-8	A
Burst	2kV 5kHz	EN61000-4-4	B
Surge	1.2µs/50µs 1kV (Line to line) 2kV (Line to ground)	EN61000-4-5	B
Conducted RF	0.15 to 80MHz 3V 80%AM (1kHz)	EN61000-4-6	A

Note) Definition of performance criteria

A: During testing, normal performance within the specification limits.

B: During testing, temporary degradation, or loss of function or performance which is self-recovering.

ORDERING INFORMATION

When ordering this instrument, specify.

1. CODE SYMBOLS
2. Measuring range.
3. Output orientation (burnout direction) when abnormality is occurred in the transmitter.
 Hold / Overscale (21.6mA) / Underscale (3.2mA)
 Unless otherwise specified, output hold function is supplied.
4. Indication method (indicated value and unit) in case of the actual scale (code D, H, P, S on 9th digit).
5. Tag No. (up to 26 alphanumeric characters), if required.

⚠ Caution on Safety

*Before using this product, be sure to read its instruction manual in advance.

Fuji Electric Systems Co., Ltd.

Head Office

Gate City Ohsaki, East Tower, 11-2, Osaki 1-chome,
Shinagawa-ku, Tokyo 141-0032, Japan

<http://www.fesys.co.jp/eng>

Instrumentation Div.

International Sales Dept.

No.1, Fuji-machi, Hino-city, Tokyo, 191-8502 Japan

Phone: 81-42-585-6201, 6202 Fax: 81-42-585-6187

<http://www.fic-net.jp/eng>

Information in this catalog is subject to change without notice.

Printed in Japan