

**NPN Silicon AF and Switching Transistor**

- For general AF applications
- High breakdown voltage
- Low collector-emitter saturation voltage
- Complementary type: BCX42 (PNP)
- Pb-free (RoHS compliant) package
- Qualified according AEC Q101

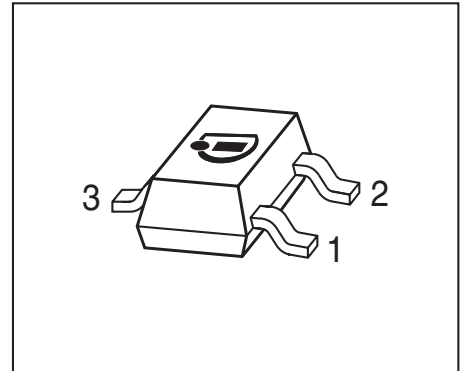

Type	Marking	Pin Configuration			Package
		1 = B	2 = E	3 = C	
BCX41	EKs	1 = B	2 = E	3 = C	SOT23

**Maximum Ratings**

Parameter	Symbol	Value	Unit
Collector-emitter voltage	$V_{CEO}$	125	V
Collector-base voltage	$V_{CBO}$	125	
Emitter-base voltage	$V_{EBO}$	5	
Collector current	$I_C$	800	mA
Peak collector current, $t_p \leq 10$ ms	$I_{CM}$	1	A
Base current	$I_B$	100	mA
Peak base current	$I_{BM}$	200	
Total power dissipation $T_S \leq 79$ °C	$P_{tot}$	330	mW
Junction temperature	$T_j$	150	°C
Storage temperature	$T_{stg}$	-65 ... 150	

**Thermal Resistance**

Parameter	Symbol	Value	Unit
Junction - soldering point <sup>1)</sup>	$R_{thJS}$	$\leq 215$	K/W

<sup>1)</sup>For calculation of  $R_{thJA}$  please refer to Application Note AN077 (Thermal Resistance Calculation)

**Electrical Characteristics** at  $T_A = 25^\circ\text{C}$ , unless otherwise specified

Parameter	Symbol	Values			Unit
		min.	typ.	max.	
<b>DC Characteristics</b>					
Collector-emitter breakdown voltage $I_C = 10\text{ mA}, I_B = 0$	$V_{(BR)CEO}$	125	-	-	V
Collector-base breakdown voltage $I_C = 100\text{ }\mu\text{A}, I_E = 0$	$V_{(BR)CBO}$	125	-	-	
Emitter-base breakdown voltage $I_E = 10\text{ }\mu\text{A}, I_C = 0$	$V_{(BR)EBO}$	5	-	-	
Collector-base cutoff current $V_{CB} = 100\text{ V}, I_E = 0$ $V_{CB} = 100\text{ V}, I_E = 0, T_A = 150\text{ }^\circ\text{C}$	$I_{CBO}$	-	-	0.1 20	$\mu\text{A}$
Collector-emitter cutoff current $V_{CE} = 100\text{ V}, T_A = 85\text{ }^\circ\text{C}$ $V_{CE} = 100\text{ V}, T_A = 125\text{ }^\circ\text{C}$	$I_{CEO}$	-	-	10 75	
Emitter-base cutoff current $V_{EB} = 4\text{ V}, I_C = 0$	$I_{EBO}$	-	-	100	nA
DC current gain <sup>1)</sup> $I_C = 100\text{ }\mu\text{A}, V_{CE} = 1\text{ V}$ $I_C = 100\text{ mA}, V_{CE} = 1\text{ V}$ $I_C = 200\text{ mA}, V_{CE} = 1\text{ V}$	$h_{FE}$	25 63 40	- - -	- - -	-
Collector-emitter saturation voltage <sup>1)</sup> $I_C = 300\text{ mA}, I_B = 30\text{ mA}$	$V_{CEsat}$	-	-	0.9	V
Base emitter saturation voltage <sup>1)</sup> $I_C = 300\text{ mA}, I_B = 30\text{ mA}$	$V_{BEsat}$	-	-	1.4	
<b>AC Characteristics</b>					
Transition frequency $I_C = 20\text{ mA}, V_{CE} = 5\text{ V}, f = 20\text{ MHz}$	$f_T$	-	100	-	MHz
Collector-base capacitance $V_{CB} = 10\text{ V}, f = 1\text{ MHz}$	$C_{cb}$	-	12	-	pF

<sup>1)</sup>Pulse test:  $t < 300\mu\text{s}; D < 2\%$

**DC current gain  $h_{FE} = f(I_C)$**

$V_{CE} = 1\text{ V}$

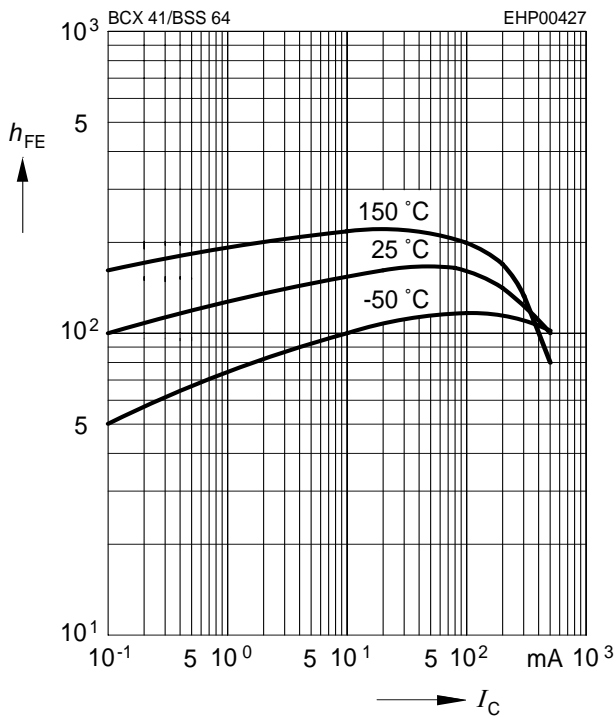

**Collector-emitter saturation voltage**

$I_C = f(V_{CEsat}), h_{FE} = 10$

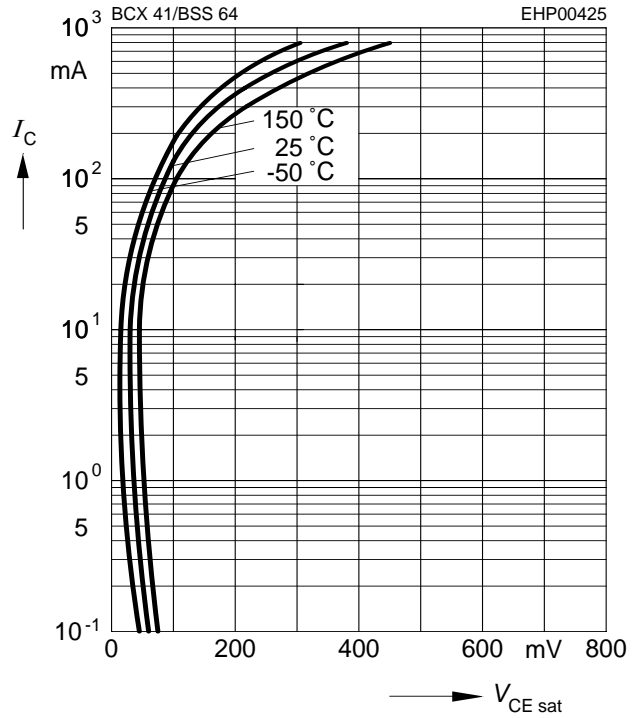

**Base-emitter saturation voltage**

$I_C = f(V_{BEsat}), h_{FE} = 10$

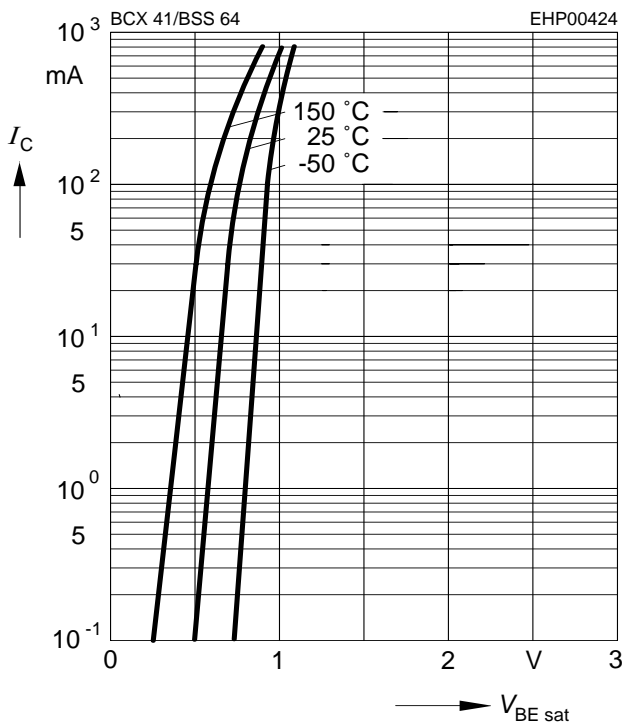

**Collector current  $I_C = f(V_{BE})$**

$V_{CE} = 1\text{ V}$

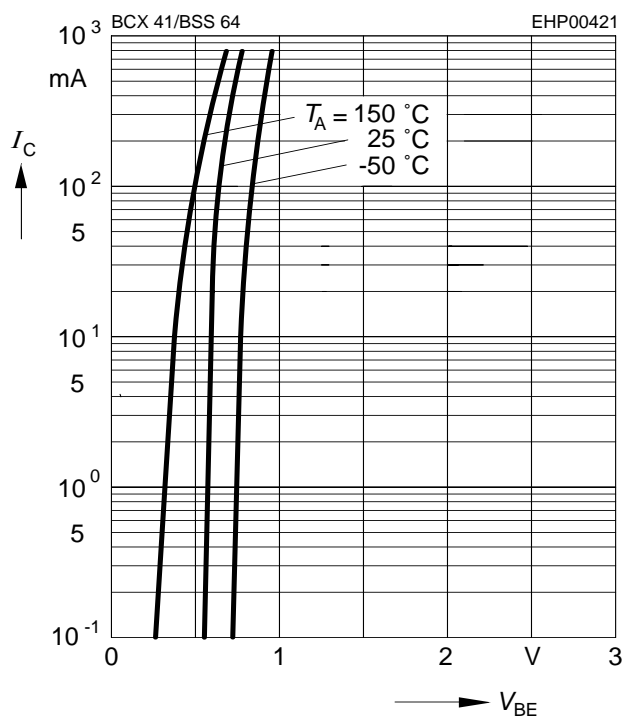

**Collector cutoff current  $I_{CBO} = f(T_A)$**

$V_{CBO} = 80\text{ V}$

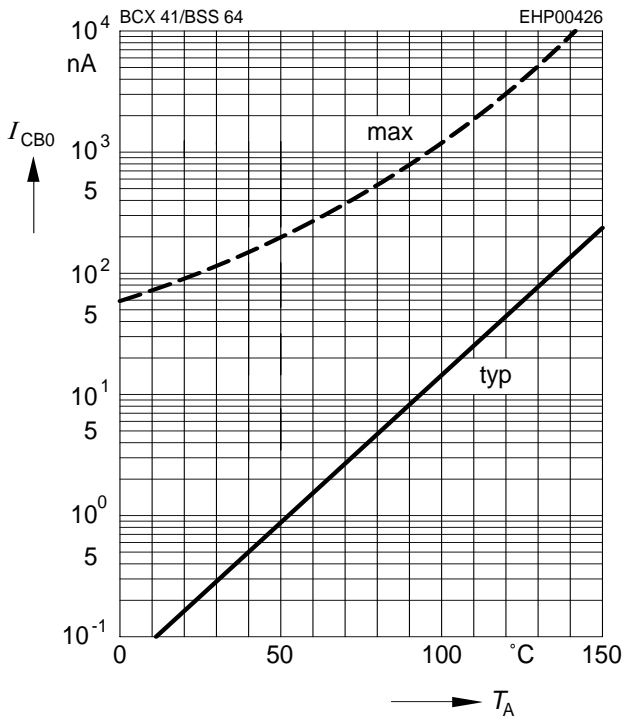

**Transition frequency  $f_T = f(I_C)$**

$V_{CE} = 5\text{ V}$

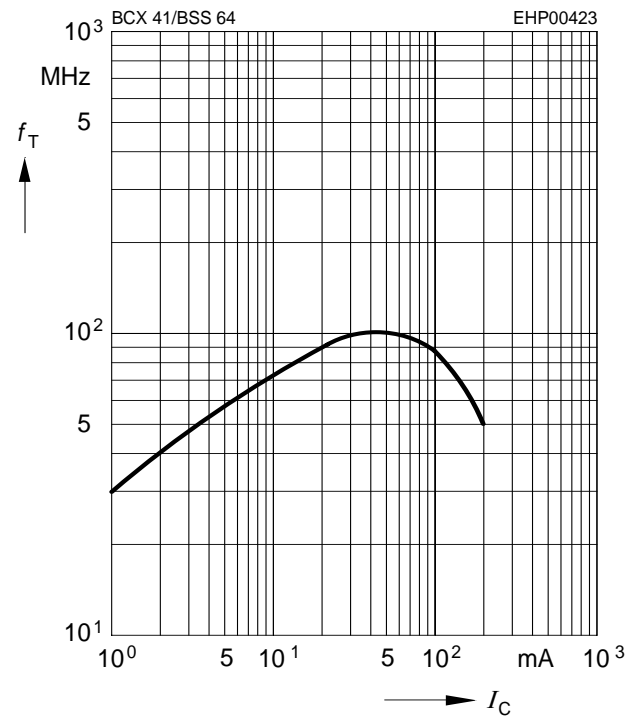

**Collector-base capacitance  $C_{cb} = f(V_{CB})$**

**Emitter-base capacitance  $C_{eb} = f(V_{EB})$**

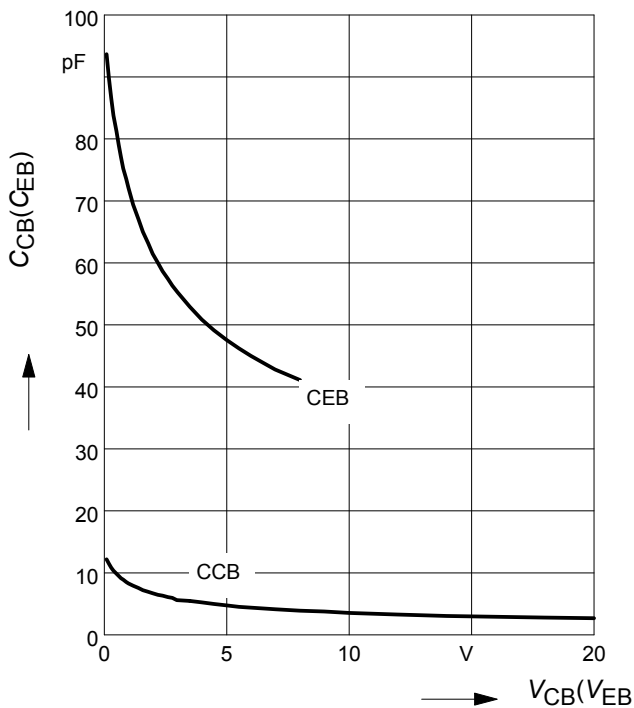

**Total power dissipation  $P_{tot} = f(T_S)$**

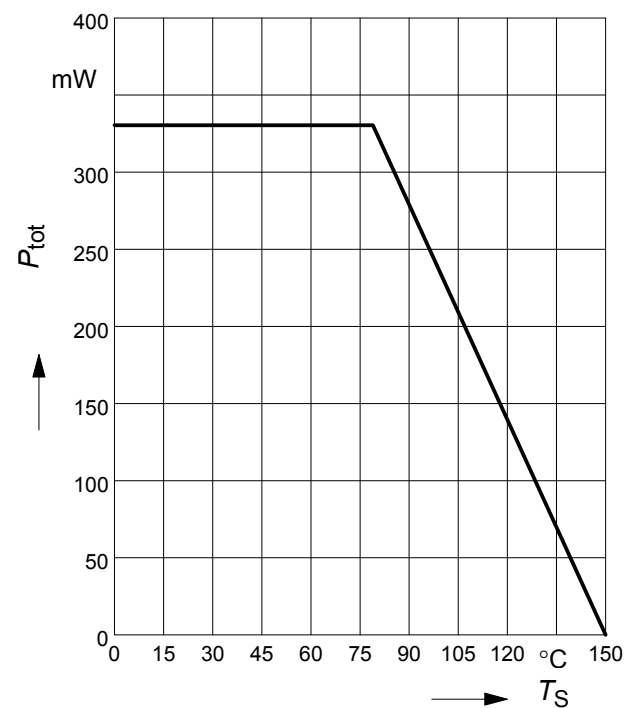

**Permissible Pulse Load**

$$P_{\text{totmax}}/P_{\text{totDC}} = f(t_p)$$

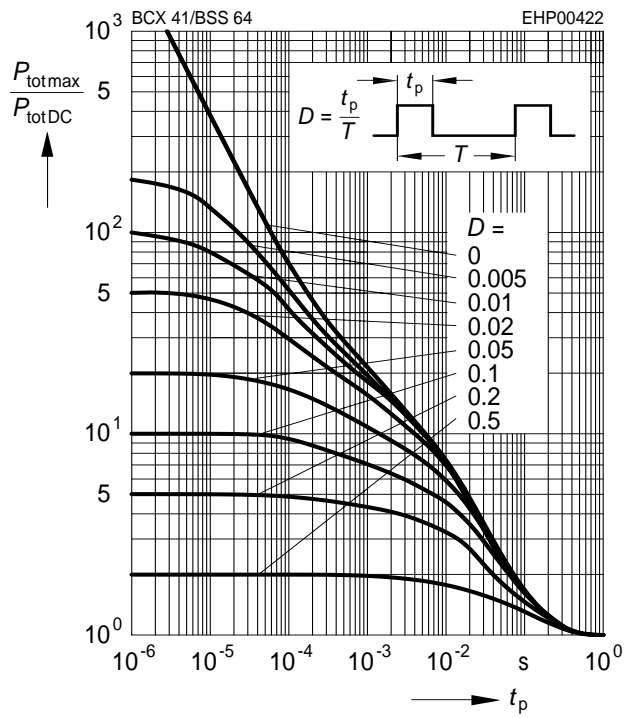

Package Outline



1) Lead width can be 0.6 max. in dambar area

Foot Print



Marking Layout (Example)



Standard Packing

Reel  $\varnothing$ 180 mm = 3.000 Pieces/Reel  
 Reel  $\varnothing$ 330 mm = 10.000 Pieces/Reel



**Edition 2009-11-16**

**Published by  
Infineon Technologies AG  
81726 Munich, Germany**

**© 2009 Infineon Technologies AG  
All Rights Reserved.**

### **Legal Disclaimer**

The information given in this document shall in no event be regarded as a guarantee of conditions or characteristics. With respect to any examples or hints given herein, any typical values stated herein and/or any information regarding the application of the device, Infineon Technologies hereby disclaims any and all warranties and liabilities of any kind, including without limitation, warranties of non-infringement of intellectual property rights of any third party.

### **Information**

For further information on technology, delivery terms and conditions and prices, please contact the nearest Infineon Technologies Office ([www.infineon.com](http://www.infineon.com)).

### **Warnings**

Due to technical requirements, components may contain dangerous substances. For information on the types in question, please contact the nearest Infineon Technologies Office.

Infineon Technologies components may be used in life-support devices or systems only with the express written approval of Infineon Technologies, if a failure of such components can reasonably be expected to cause the failure of that life-support device or system or to affect the safety or effectiveness of that device or system. Life support devices or systems are intended to be implanted in the human body or to support and/or maintain and sustain and/or protect human life. If they fail, it is reasonable to assume that the health of the user or other persons may be endangered.