

Features

- For Surface Mount Applications
- Extremely Low Thermal Resistance
- Easy Pick And Place
- High Temp Soldering: 250°C for 10 Seconds At Terminals

Maximum Ratings

- Operating Temperature: -65°C to +175°C
- Storage Temperature: -65°C to +175°C
- Maximum Thermal Resistance; 15 °C/W Junction To Lead

1 Amp Silicon Rectifier 50 to 1000 Volts

Device Marking	Maximum Recurrent Peak Reverse Voltage	Maximum RMS Voltage	Maximum DC Blocking Voltage
M1	50V	35V	50V
M2	100V	70V	100V
M3	200V	140V	200V
M4	400V	280V	400V
M5	600V	420V	600V
M6	800V	560V	800V
M7	1000V	700V	1000V

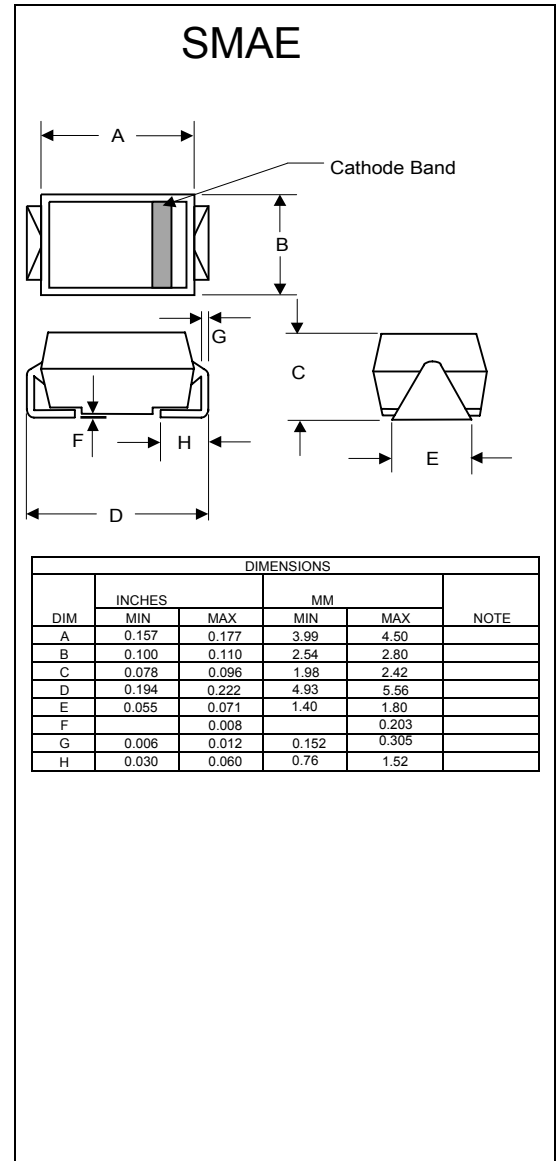

Electrical Characteristics @ 25°C Unless Otherwise Specified

Average Forward current	$I_{F(AV)}$	1.0A	$T_J = 75^\circ\text{C}$
Peak Forward Surge Current	I_{FSM}	50A	8.3ms, half sine, $T_J = 150^\circ\text{C}$
Maximum Instantaneous Forward Voltage	V_F	1.1V	$I_{FM} = 1.0A$; $T_J = 25^\circ\text{C}^*$
Maximum DC Reverse Current At Rated DC Blocking Voltage	I_R	10 μA 50 μA	$T_J = 25^\circ\text{C}$ $T_J = 125^\circ\text{C}$
Maximum Reverse Recovery Time	T_{rr}	1.8 μs	$I_F=0.5A, I_R=1.0A,$ $I_{rr}=0.25A$
Typical Junction Capacitance	C_J	15pF	Measured at 1.0MHz, $V_R=4.0V$

*Pulse test: Pulse width 300 μsec , Duty cycle 2%



GS1A THRU GS1M

Figure 1
Typical Forward Characteristics

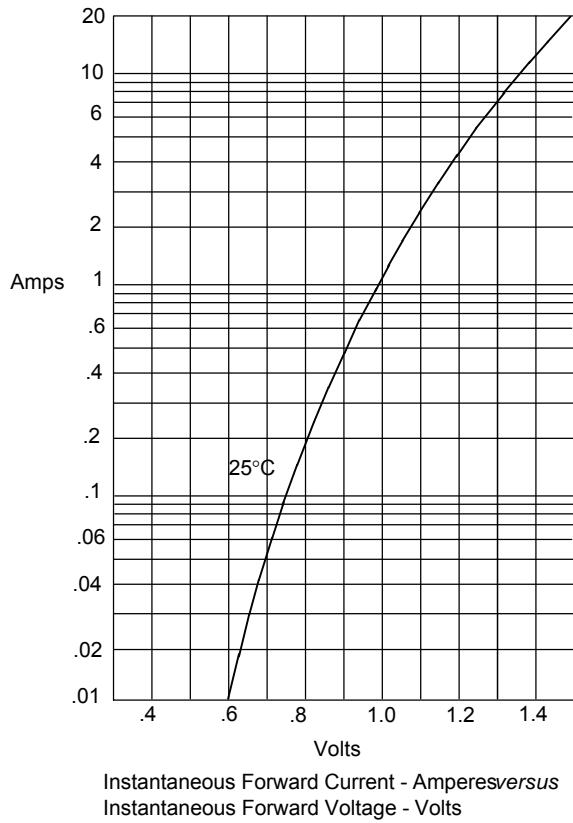
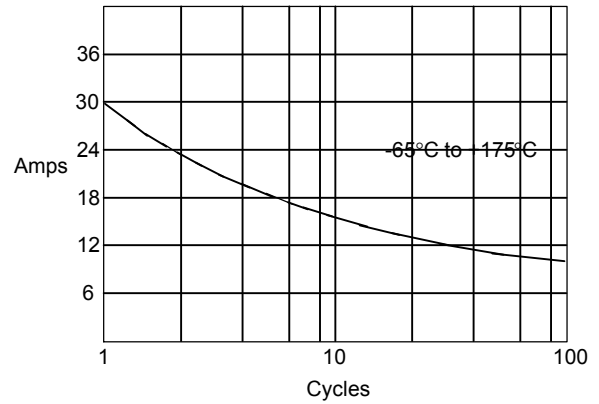
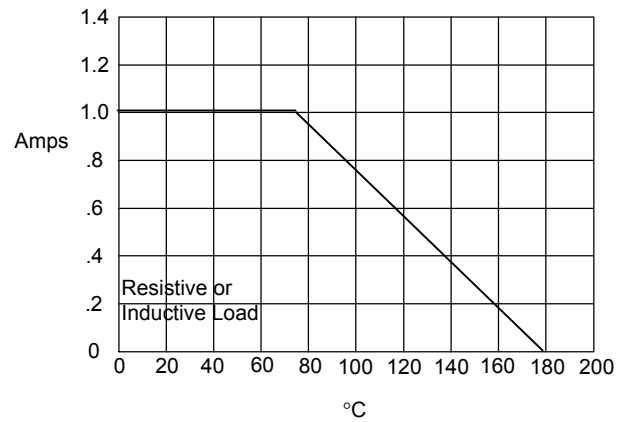

Figure 3
Maximum Overload Surge Current



Peak Forward Current - Amperes versus Number of Cycles at 60Hz

Figure 4
Forward Derating Curve



Average Forward Rectified Current - Amperes versus Ambient Temperature - °C

Figure 2
Junction Capacitance

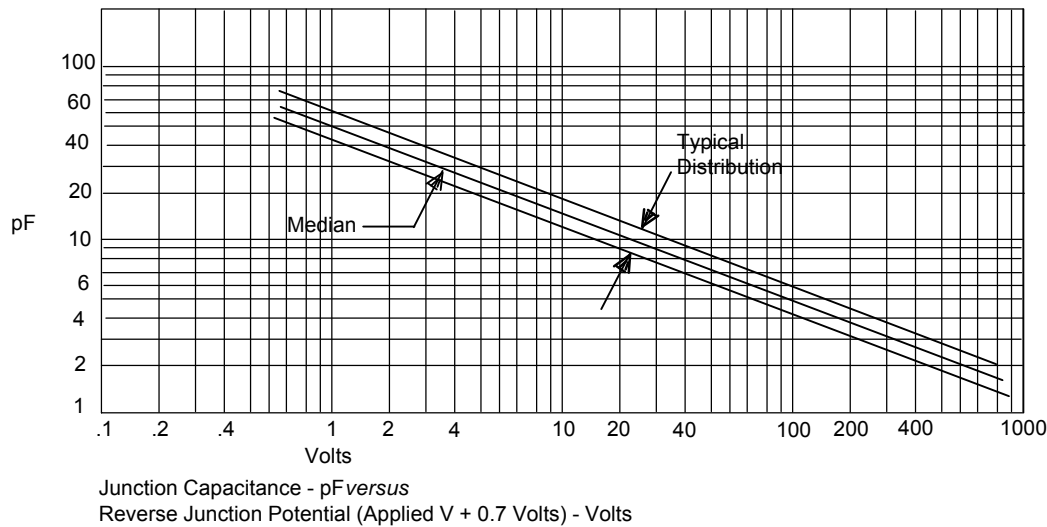



GS1A THRU GS1M

Figure 5
Peak Forward Surge Current

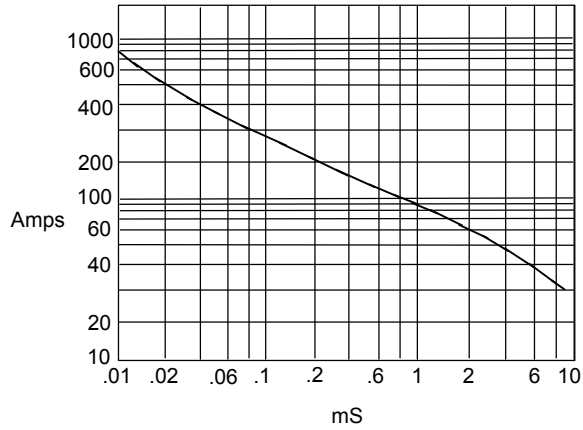

Peak Forward Surge Current - Amperes versus
Pulse Duration - Milliseconds (mS)

Figure 6
New SMB Assembly

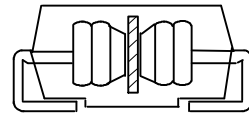

Round Lead
Process