



# Frontier Electronics Corp.

667 E. COCHRAN STREET, SIMI VALLEY, CA 93065

TEL: (805) 522-9998 FAX: (805) 522-9989

E-mail: [frontiersales@frontierusa.com](mailto:frontiersales@frontierusa.com)

Web: <http://www.frontierusa.com>

## 2A ULTRA FAST RECOVERY SURFACE MOUNT RECTIFIER

### MURS205 THRU MURS260

#### FEATURES

- LOW PROFILE PACKAGE
- PLASTIC PACKAGE HAS UNDERWRITERS LABORATORY 94V-0
- IDEAL FOR SURFACE MOUNTED APPLICATION
- GLASS PASSIVATED CHIP JUNCTION
- BUILT-IN STRAIN RELIEF DESIGN
- ULTRA FAST RECOVERY TIME FOR HIGH EFFICIENT
- HIGH TEMPERATURE SOLDERING: 250°C/10 SECONDS AT TERMINALS

#### MECHANICAL DATA

- CASE: JEDEC DO-214AA MOLDED PLASTIC BODY, DIMENSIONS IN INCHES AND (MILLIMETERS)
- TERMINAL: SOLDER PLATED, SOLDERABLE PER MIL-STD-750 METHOD 2026
- POLARITY: COLOR BAND DENOTES CATHODE
- WEIGHT: 0.093 GRAMS

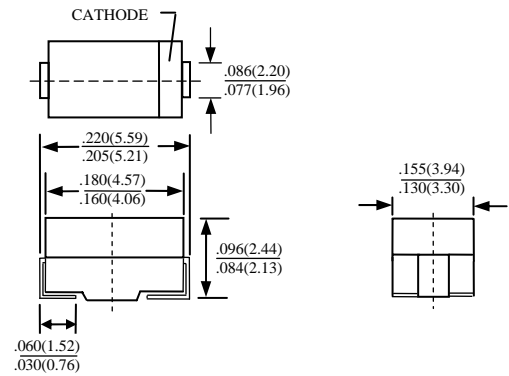

#### MAXIMUM RATINGS AND ELECTRICAL CHARACTERISTICS

RATINGS AT 25°C AMBIENT TEMPERATURE UNLESS OTHERWISE SPECIFIED

SINGLE PHASE, HALF WAVE, 60 HZ, RESISTIVE OR INDUCTIVE LOAD.

FOR CAPACITIVE LOAD, DERATE CURRENT BY 20%

RATINGS	SYMBOL	MURS 205	MURS 210	MURS 215	MURS 220	MURS 240	MURS 260	UNITS
MAXIMUM RECURRENT PEAK REVERSE VOLTAGE	$V_{RRM}$	50	100	150	200	400	600	V
MAXIMUM RMS VOLTAGE	$V_{RMS}$	35	70	105	140	280	420	V
MAXIMUM DC BLOCKING VOLTAGE	$V_{DC}$	50	100	150	200	400	600	V
MAXIMUM AVERAGE FORWARD RECTIFIED CURRENT AT $T_J=75^\circ\text{C}$	$I_O$	2.0						A
PEAK FORWARD SURGE CURRENT, 8.3ms SINGLE HALF SINE-WAVE SUPERIMPOSED ON RATED LOAD	$I_{FSM}$	40				35		A
TYPICAL JUNCTION CAPACITANCE (NOTE 1)	$C_j$	50						PF
TYPICAL THERMAL RESISTANCE (NOTE 2)	$R_{\theta JL}$	15						°C/W
STORAGE TEMPERATURE RANGE	$T_{STG}$	-55 TO + 150						°C
OPERATING TEMPERATURE RANGE	$T_{OP}$	-55 TO + 150						°C

#### ELECTRICAL CHARACTERISTICS (AT $T_A=25^\circ\text{C}$ UNLESS OTHERWISE NOTED)

CHARACTERISTICS	SYMBOL	MURS 205	MURS 210	MURS 215	MURS 220	MURS 240	MURS 260	UNITS
MAXIMUM FORWARD VOLTAGE AT $I_O$ DC	$V_F$	0.94				1.45		V
MAXIMUM DC REVERSE CURRENT AT $T_A=25^\circ\text{C}$	$I_R$	2				5		$\mu\text{A}$
MAXIMUM DC REVERSE CURRENT AT $T_A=125^\circ\text{C}$	$I_R$	250						$\mu\text{A}$
MAXIMUM REVERSE RECOVERY TIME (NOTE 3)	$T_{RR}$	20				50		nS
MARKING		U2A	U2B	U2C	U2D	U2G	U2J	

NOTES : 1. MEASURED AT 1 MHZ AND APPLIED REVERSE VOLTAGE OF 4.0 VOLTS

2. THERMAL RESISTANCE FROM JUNCTION TO AMBIENT AND JUNCTION TO LEAD P.C.B. MOUNTED ON 0.3x0.3" ( 8.0x8.0 mm) COPPER PAD AREAS

3. REVERSE RECOVERY TEST CONDITIONS:  $I_F=0.5\text{A}$ ,  $I_R=1.0\text{A}$ ,  $I_{RR}=0.25\text{A}$

# RATINGS AND CHARACTERISTIC CURVE MURS205 THRU MURS260

FIG. 1-TEST CIRCUIT DIAGRAM AND REVERSE RECOVERY TIME CHARACTERISTIC

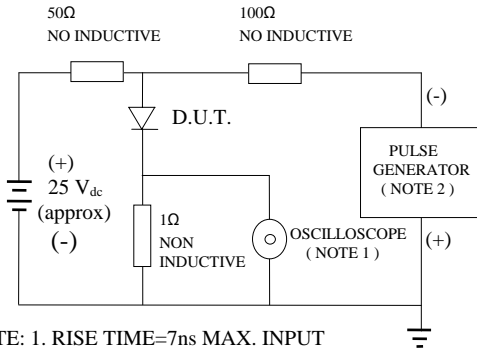

NOTE: 1. RISE TIME=7ns MAX. INPUT IMPEDANCE=1 MOhms 22PF  
 2. RISE TIME =10ns MAX. SOURCE IMPEDANCE=50 OHMS

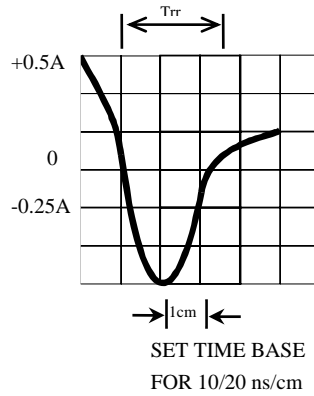

FIG. 2-TYPICAL FORWARD CURRENT DERATING CURVE

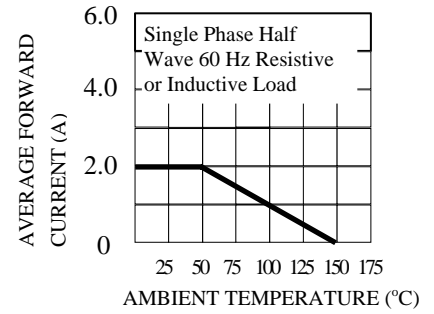

FIG. 3-TYPICAL REVERSE CHARACTERISTICS

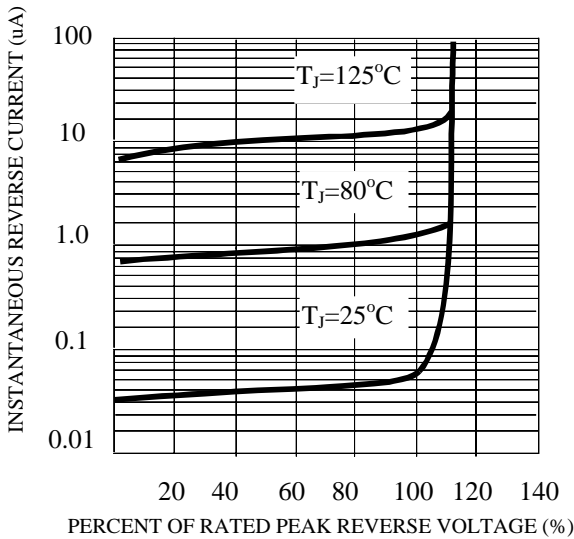

FIG. 4-TYPICAL INSTANTANEOUS FORWARD CHARACTERISTICS

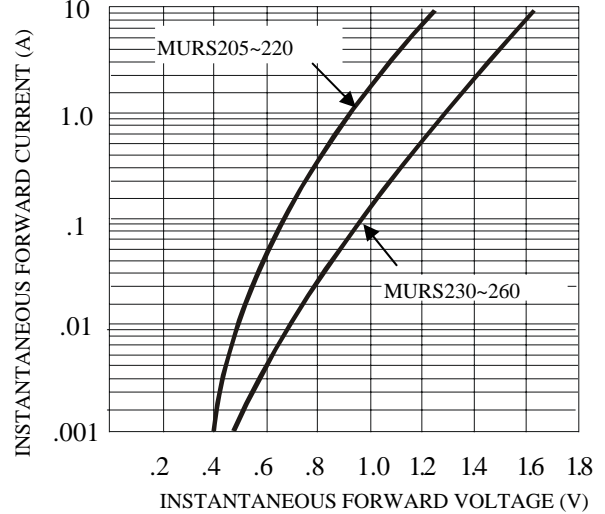

FIG. 5-MAXIMUM NON-REPETITIVE FORWARD SURGE CURRENT

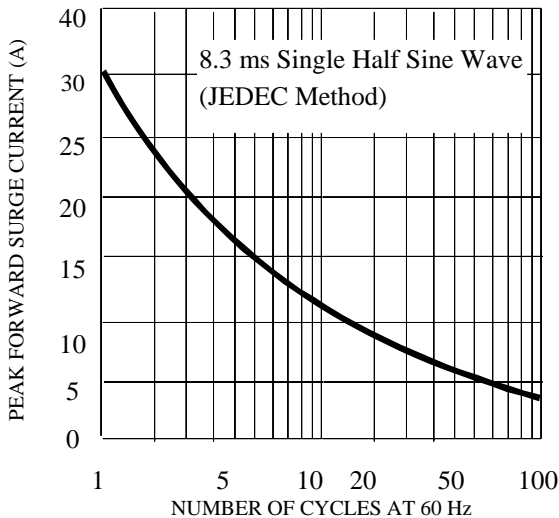

FIG. 6-TYPICAL JUNCTION CAPACITANCE

