

FEATURES

- InGaP HBT Technology
- -50 dBc ACPR @ ± 5 MHz, +24.5 dBm
- 30 dB Gain
- High Efficiency
- Low Transistor Junction Temperature
- Internally Matched for a 50 Ω System
- Low Profile Miniature Surface Mount Package; Halogen Free and RoHS Compliant
- Multi-Carrier Capability

APPLICATIONS

- WCDMA, HSDPA and LTE Air Interfaces
- Picocell, Femtocell, Home Nodes
- Customer Premises Equipment (CPE)
- Data Cards and Terminals

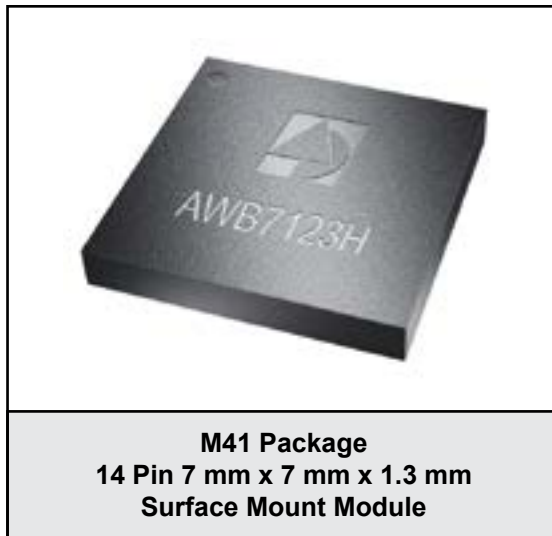

PRODUCT DESCRIPTION

The AWB7123 is a highly linear, fully matched, power amplifier module designed for picocell, femtocell, and customer premises equipment (CPE) applications. Its high power efficiency and low adjacent channel power levels meet the extremely demanding needs of small cell infrastructure architectures. Designed for WCDMA, HSDPA, and LTE air interfaces operating in the 1.93 GHz to 1.99 GHz band, the AWB7123 delivers up to +24.5 dBm of WCDMA (64 DPCH)

power with an ACPR of -50 dBc. It operates from a convenient +4.2 V supply and provides 30 dB of gain. The device is manufactured using an advanced InGaP HBT MMIC technology offering state-of-the-art reliability, temperature stability, and ruggedness. The self-contained 7 mm x 7 mm x 1.3 mm surface mount package incorporates RF matching networks optimized for output power, efficiency, and linearity in a 50 Ω system.

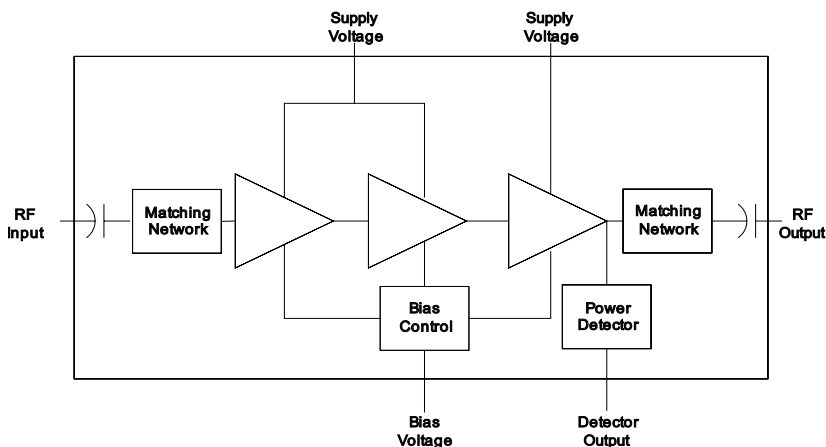

Figure 1: Block Diagram

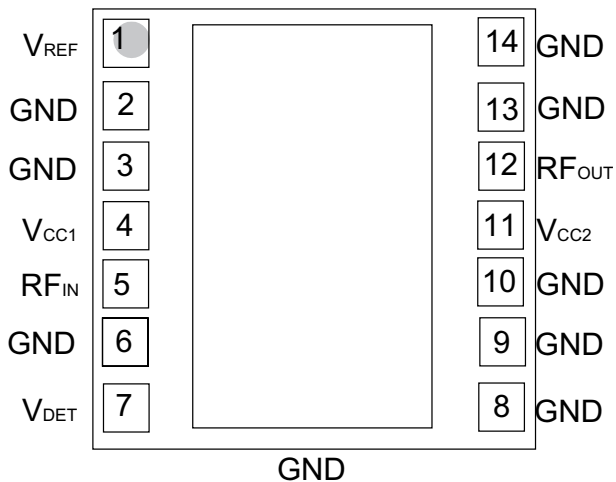

Figure 2: Pinout (X-ray Top View)

Table 1: Pin Description

PIN	NAME	DESCRIPTION
1	V _{REF}	Reference Voltage
2	GND	Ground
3	GND	Ground
4	V _{CC1}	Supply Voltage
5	RF _{IN}	RF Input
6	GND	Ground
7	V _{DET}	Detector Voltage
8	GND	Ground
9	GND	Ground
10	GND	Ground
11	V _{CC2}	Supply Voltage
12	RF _{OUT}	RF Output
13	GND	Ground
14	GND	Ground

ELECTRICAL CHARACTERISTICS

Table 2: Absolute Minimum and Maximum Ratings

PARAMETER	MIN	MAX	UNIT
Supply Voltage (V_{CC})	0	+5	V
Reference Voltage (V_{REF})	0	+3.5	V
ESD Rating Human Body Model ⁽¹⁾ Charged Device Model ⁽²⁾	Class 1C Class IV	- -	
MSL Rating ⁽³⁾	4	-	-
RF Output Power (P_{OUT})	-	+28	dBm
Storage Temperature (T_{STG})	-40	+150	°C

Stresses in excess of the absolute ratings may cause permanent damage. Functional operation is not implied under these conditions. Exposure to absolute ratings for extended periods of time may adversely affect reliability.

Notes:

(1) JEDEC JS-001-2010

(2) JEDEC JESD22-C101D

(3) 260 °C peak reflow

Table 3: Operating Ranges

PARAMETER	MIN	TYP	MAX	UNIT	COMMENTS
Operating Frequency (f)	1930	-	1990	MHz	
Supply Voltage (V_{CC})	+3.2	+4.2	+4.5	V	
Reference Voltage (V_{REF})	+2.80 0	+2.85 -	+2.90 +0.5	V	PA "on" PA "shut down"
RF Output Power (P_{OUT})	-	+24.5	-	dBm	
Case Temperature (T_C)	-40	-	+85	°C	

The device may be operated safely over these conditions; however, parametric performance is guaranteed only over the conditions defined in the electrical specifications.

Table 4: Electrical Specifications
 (T_C = +25 °C, V_{CC} = +4.2 V, V_{REF} = +2.85 V, 50 Ω system)

PARAMETER	MIN	TYP	MAX	UNIT	COMMENTS
Gain ⁽²⁾	28	31	-	dB	
ACPR ^{(1), (2), (3)} @ 5 MHz @ 10 MHz	- -	-50 -62	-48 -60	dBc	
Power-Added Efficiency ^{(1), (2), (3)}	-	17	-	%	
Thermal Resistance	-	21	-	°C/W	Junction to Case
Supply Current ^{(1), (2), (3)}	-	395	-	mA	Total through V _{CC} pins
Quiescent Current (I _q)	-	120	-	mA	
Reference Current	-	6.5	-	mA	through V _{REF} pin
Leakage Current	-	1.5	5	μA	V _{CC} = +5 V, V _{REF} = 0 V
Harmonics 2fo 3fo, 4fo	- -	-54 -62	-46 -56	dBc	
Input Return Loss	10	14	-	dB	
Spurious Output Level (all spurious outputs)	-	-	-60	dBc	P _{OUT} ≤ +24.5 dBm In-band load VSWR < 5:1 Out-of-band load VSWR < 10:1 Applies over all voltage and temperature operating ranges
Load mismatch stress with no permanent degradation or failure	8:1	-	-	VSWR	V _{CC} = +4.2 V, P _{IN} = 0 dBm Applies over full operating temperature range

Notes:

- (1) Measured at 1960 MHz.
 (2) P_{OUT} = +24.5 dBm.
 (3) TM1 WCDMA 64DPCH

APPLICATION INFORMATION

To ensure proper performance, refer to all related Application Notes on the ANADIGICS web site: <http://www.anadigics.com>

Shutdown Mode

The power amplifier may be placed in a shutdown mode by applying logic low levels (see Operating Ranges table) to the V_{REF} voltage.

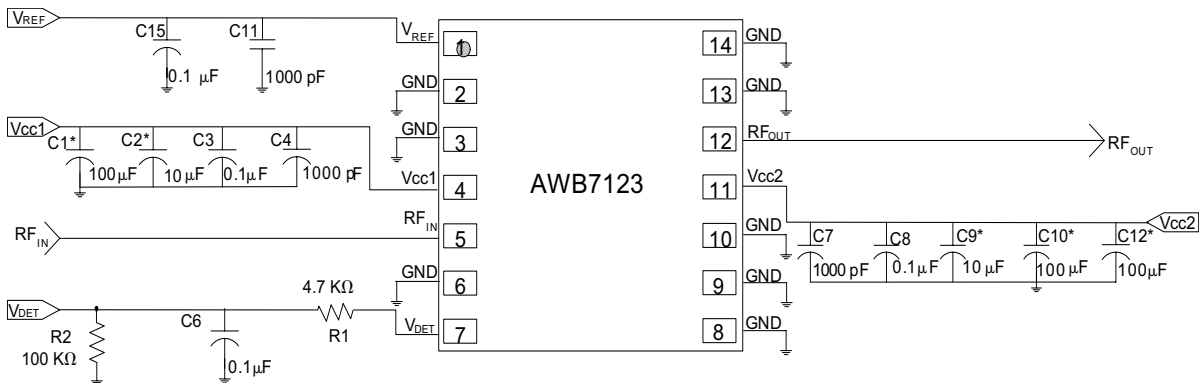

* Optional

Figure 3: Application Circuit Schematic

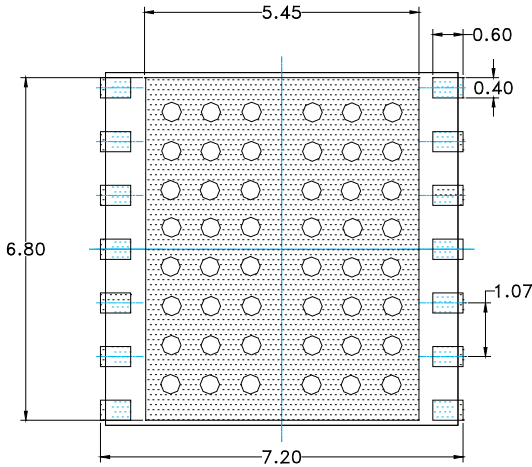

NOTES:

- (1) UNLESS SPECIFIED DIMENSIONS ARE SYMMETRICAL ABOUT CENTER LINES SHOWN.
- (2) DIMENSIONS IN MILLIMETERS.
- (3) VIAS SHOWN IN PCB METAL VIEW ARE FOR REFERENCE ONLY. NUMBER & SIZE OF THERMAL VIAS REQUIRED DEPENDENT ON HEAT DISSIPATION REQUIREMENT AND THE PCB PROCESS CAPABILITY.

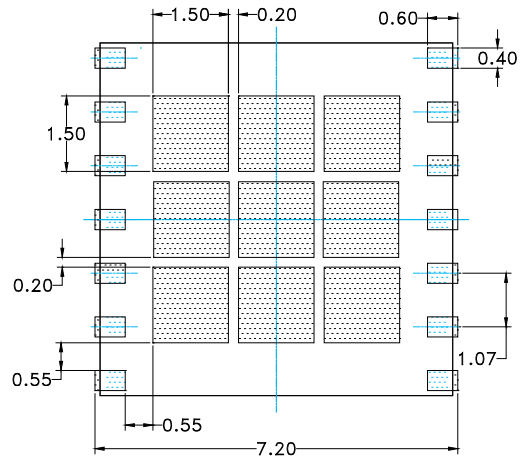
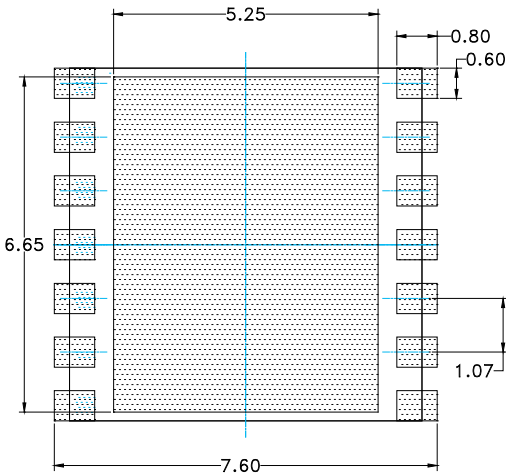
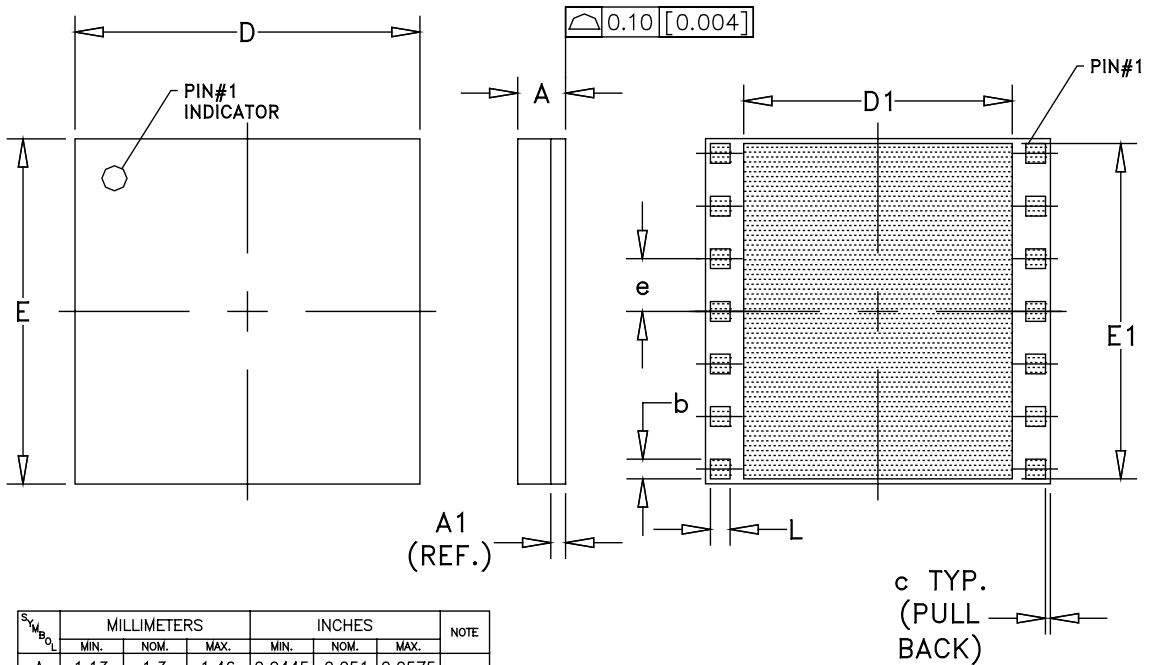

Figure 4: PCB Footprint

PACKAGE OUTLINE



Symbol	MILLIMETERS			INCHES			NOTE
	MIN.	NOM.	MAX.	MIN.	NOM.	MAX.	
A	1.13	1.3	1.46	0.0445	0.051	0.0575	—
A1	0.3(REF.)			0.011(REF.)			—
b	0.387	0.400	0.413	0.0152	0.0157	0.0162	14X
c	—	0.10	—	—	0.004	—	—
D	6.88	7.00	7.12	0.270	0.275	0.280	—
D1	5.30	5.45	5.60	0.208	0.214	0.220	—
E	6.88	7.00	7.12	0.270	0.275	0.280	—
E1	6.78	6.80	6.82	0.266	0.267	0.268	—
e	1.07			0.0421			6X
L	0.387	0.400	0.413	0.0152	0.0157	0.0162	14X

NOTES:

1. CONTROLLING DIMENSIONS: MILLIMETERS
2. UNLESS SPECIFIED TOLERANCE=±0.076[0.003].
3. PADS (INCLUDING CENTER) SHOWN UNIFORM SIZE FOR REFERENCE ONLY. ACTUAL PAD SIZE AND LOCATION WILL VARY WITHIN MIN. AND MAX. DIMENSIONS ACCORDING TO SPECIFIC LAMINATE DESIGN.

Figure 5: M41 Package Outline - 14 Pin 7 mm x 7 mm x 1.3 mm Surface Mount Module

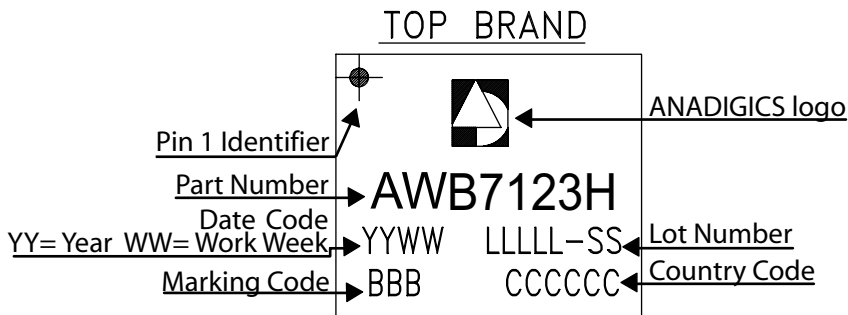

Figure 6: Branding Specification

COMPONENT PACKAGING

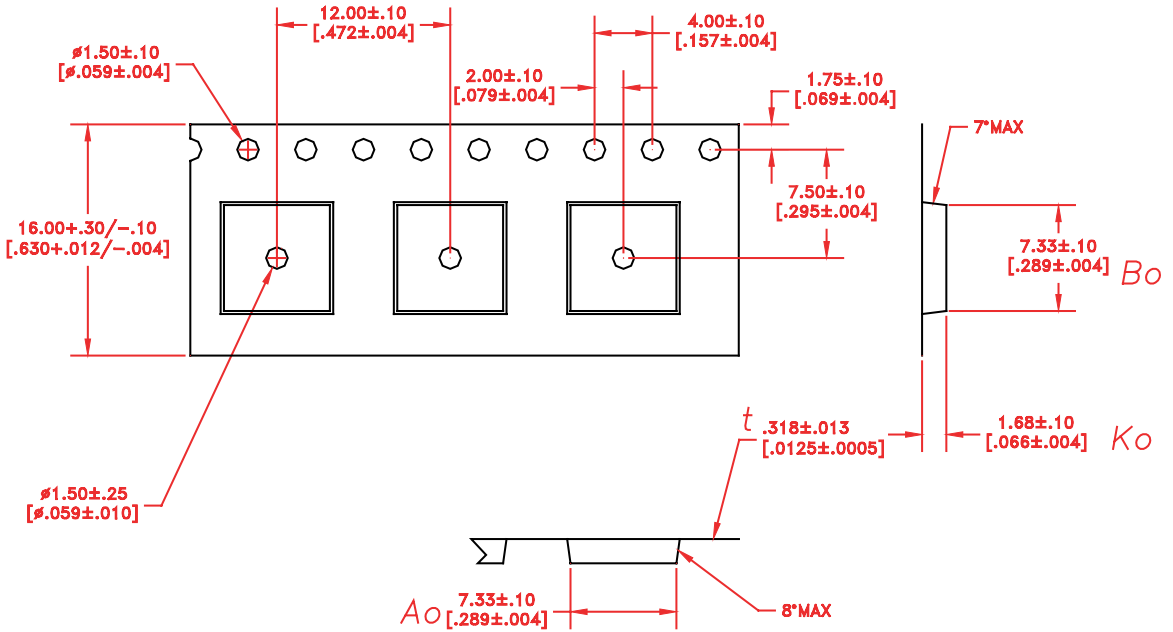

Figure 7: Tape & Reel Packaging

Table 5: Tape & Reel Dimensions

PACKAGE TYPE	TAPE WIDTH	POCKET PITCH	REEL CAPACITY	MAX REEL DIA
7 mm x 7 mm x 1.3 mm	12 mm	8 mm	2500	13"

ORDERING INFORMATION

ORDER NUMBER	TEMPERATURE RANGE	PACKAGE DESCRIPTION	COMPONENT PACKAGING
AWB7123HM41P8	-40 °C to +85 °C	Halogen Free RoHS-compliant 14 Pin 7 mm x 7 mm x 1.3 mm Surface Mount Module	Tape and Reel, 2500 pieces per Reel



ANADIGICS

141 Mount Bethel Road
Warren, New Jersey 07059, U.S.A.
Tel: +1 (908) 668-5000
Fax: +1 (908) 668-5132

URL: <http://www.anadigics.com>

IMPORTANT NOTICE

ANADIGICS, Inc. reserves the right to make changes to its products or to discontinue any product at any time without notice. The product specifications contained in Advanced Product Information sheets and Preliminary Data Sheets are subject to change prior to a product's formal introduction. Information in Data Sheets have been carefully checked and are assumed to be reliable; however, ANADIGICS assumes no responsibilities for inaccuracies. ANADIGICS strongly urges customers to verify that the information they are using is current before placing orders.

WARNING

ANADIGICS products are not intended for use in life support appliances, devices or systems. Use of an ANADIGICS product in any such application without written consent is prohibited.