

CMF10120D-Silicon Carbide Power MOSFET

Z-FET™ MOSFET

N-Channel Enhancement Mode

V_{DS}	= 1200 V
$I_{D(MAX)}$	= 24 A
$R_{DS(on)}$	= 160mΩ

Features

- High Speed Switching with Low Capacitances
- High Blocking Voltage with Low $R_{DS(on)}$
- Easy to Parallel and Simple to Drive
- Avalanche Ruggedness
- Resistant to Latch-Up
- Halogen Free, RoHS Compliant

Benefits

- Higher System Efficiency
- Reduced Cooling Requirements
- Increased System Switching Frequency

Applications

- Solar Inverters
- High Voltage DC/DC Converters
- Motor Drives
- Switch Mode Power Supplies

Package



TO-247-3

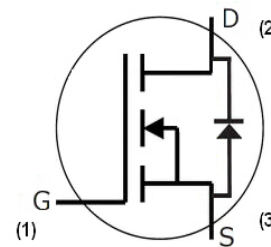

Part Number	Package
CMF10120D	TO-247-3

Maximum Ratings ($T_c = 25^\circ\text{C}$ unless otherwise specified)

Symbol	Parameter	Value	Unit	Test Conditions	Note
I_D	Continuous Drain Current	24	A	$V_{GS}@20V, T_C = 25^\circ\text{C}$	Fig. 10
		13		$V_{GS}@20V, T_C = 100^\circ\text{C}$	
I_{Dpulse}	Pulsed Drain Current	49	A	Pulse width t_p limited by T_{jmax} $T_C = 25^\circ\text{C}$	
E_{AS}	Single Pulse Avalanche Energy	1.2	J	$I_D = 10A, V_{DD} = 50 V,$ $L = 20 mH$	Fig. 15
E_{AR}	Repetitive Avalanche Energy	0.8	J		
I_{AR}	Repetitive Avalanche Current	10	A	$I_D = 10A, V_{DD} = 50 V, L = 15 mH$ t_{AR} limited by T_{jmax}	
V_{GS}	Gate Source Voltage	-5/+25	V		
P_{tot}	Power Dissipation	134	W	$T_C=25^\circ\text{C}$	Fig. 9
T_J, T_{stg}	Operating Junction and Storage Temperature	-55 to +135	$^\circ\text{C}$		
T_L	Solder Temperature	260	$^\circ\text{C}$	1.6mm (0.063") from case for 10s	
M_d	Mounting Torque	1	Nm lbf-in	M3 or 6-32 screw	
		8.8			



Electrical Characteristics (T_C = 25°C unless otherwise specified)

Symbol	Parameter	Min.	Typ.	Max.	Unit	Test Conditions	Note
V _{(BR)DSS}	Drain-Source Breakdown Voltage	1200			V	V _{GS} = 0V, I _D = 50μA	
V _{GS(th)}	Gate Threshold Voltage		2.4	3.5	V	V _{DS} = V _{GS} , I _D = 0.5 mA	Fig. 11
			3.1	4.1		V _{DS} = V _{GS} , I _D = 1.0 mA	
			1.8		V	V _{DS} = V _{GS} , I _D = 0.5 mA, T _J = 135°C	
			2.3		V	V _{DS} = V _{GS} , I _D = 1.0 mA, T _J = 135°C	
I _{DSS}	Zero Gate Voltage Drain Current		0.5	50	μA	V _{DS} = 1200V, V _{GS} = 0V	
			5	150		V _{DS} = 1200V, V _{GS} = 0V, T _J = 135°C	
I _{GSS}	Gate-Source Leakage Current			0.25	μA	V _{GS} = 20V, V _{DS} = 0V	
R _{DS(on)}	Drain-Source On-State Resistance		160	200	mΩ	V _{GS} = 20V, I _D = 10A	Fig. 3
			190	240		V _{GS} = 20V, I _D = 10A, T _J = 135°C	
g _{fs}	Transconductance		4.2		S	V _{DS} = 20V, I _{DS} = 10A	Fig. 6
			3.9			V _{DS} = 20V, I _{DS} = 10A, T _J = 135°C	
C _{iss}	Input Capacitance		928		pF	V _{GS} = 0V V _{DS} = 800V f = 1MHz	Fig. 13
C _{oss}	Output Capacitance		63				
C _{rss}	Reverse Transfer Capacitance		7.5				
E _{oss}	C _{oss} Stored Energy		32		μJ	V _{AC} = 25mV	Fig. 14
t _{d(on)V}	Turn-On Delay Time		8.8		ns	V _{DD} = 800V, V _{GS} = 0/20V I _D = 10A R _{G(ext)} = 2.5Ω, R _L = 40Ω Timing relative to V _{DS}	fig. 17
t _{fV}	Fall Time		21				
t _{d(off)V}	Turn-Off Delay Time		38				
t _{rV}	Rise Time		34				
R _G	Internal Gate Resistance		13.6		Ω	f = 1MHz, V _{AC} = 25mV	

Built-in SiC Body Diode Characteristics

Symbol	Parameter	Typ.	Max.	Unit	Test Conditions	Note
V _{SD}	Diode Forward Voltage	3.5		V	V _{GS} = -5V, I _F = 5A, T _J = 25°C	
		3.1			V _{GS} = -2V, I _F = 5A, T _J = 25°C	
t _{rr}	Reverse Recovery Time	138		ns	V _{GS} = -5V, I _F = 10A, T _J = 25°C V _R = 800V, di _F /dt = 100A/μs	Fig. 22
Q _{rr}	Reverse Recovery Charge	94		nC		
I _{rrm}	Peak Reverse Recovery Current	1.57		A		

Thermal Characteristics

Symbol	Parameter	Typ.	Max.	Unit	Test Conditions	Note
R _{θJC}	Thermal Resistance from Junction to Case	0.66	0.82	K/W		Fig. 7
R _{θCS}	Case to Sink, w/ Thermal Compound	0.25				
R _{θJA}	Thermal Resistance From Junction to Ambient		40			

Gate Charge Characteristics

Symbol	Parameter	Typ.	Max.	Unit	Test Conditions	Note
Q _{gs}	Gate to Source Charge	11.8		nC	V _{DD} = 800V, V _{GS} = 0/20V I _D = 10A Per JEDEC24 pg 27	Fig.12
Q _{gd}	Gate to Drain Charge	21.5				
Q _g	Gate Charge Total	47.1				

Typical Performance

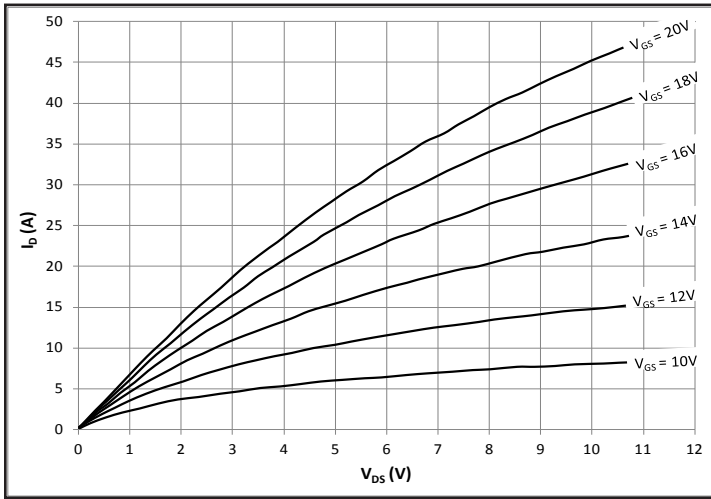

Figure 1. Typical Output Characteristics $T_j = 25^\circ\text{C}$

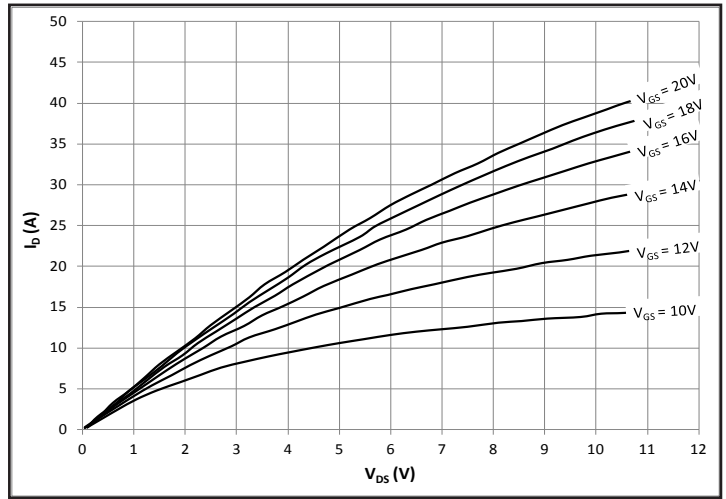

Figure 2. Typical Output Characteristics $T_j = 135^\circ\text{C}$

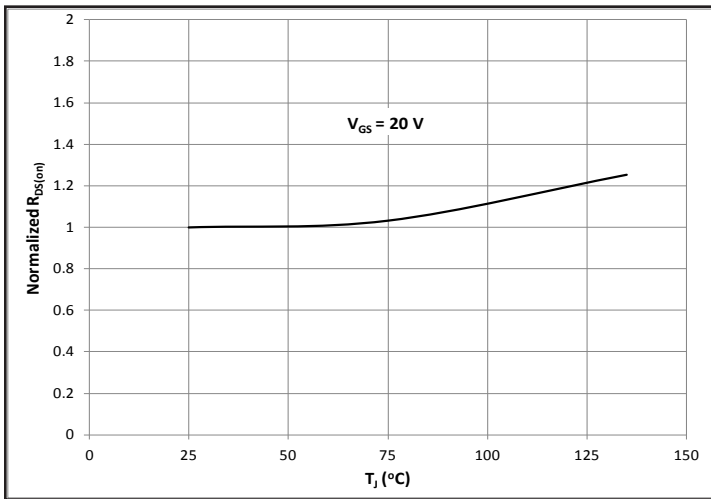

Figure 3. Normalized On-Resistance vs. Temperature

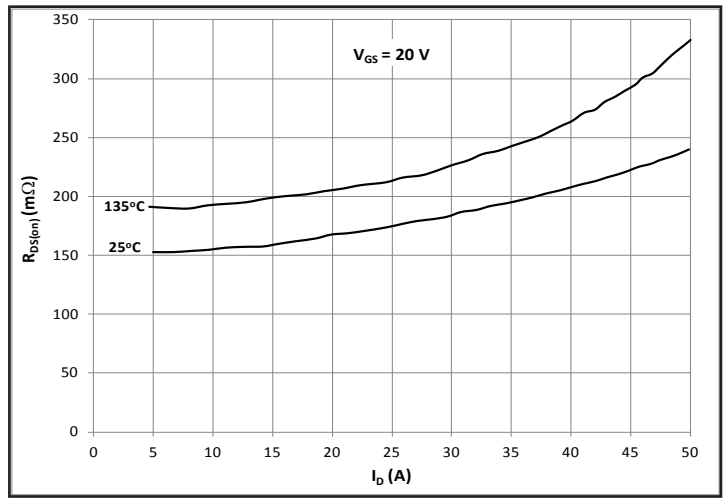

Figure 4. On-Resistance vs. Drain Current

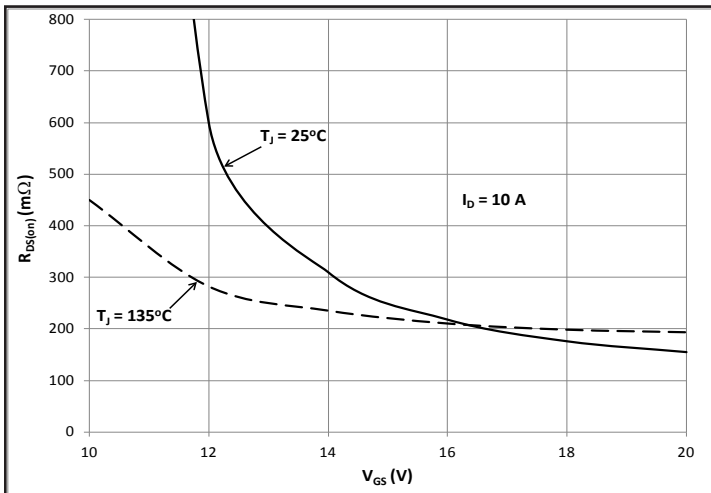

Figure 5. On-Resistance vs. Gate Voltage

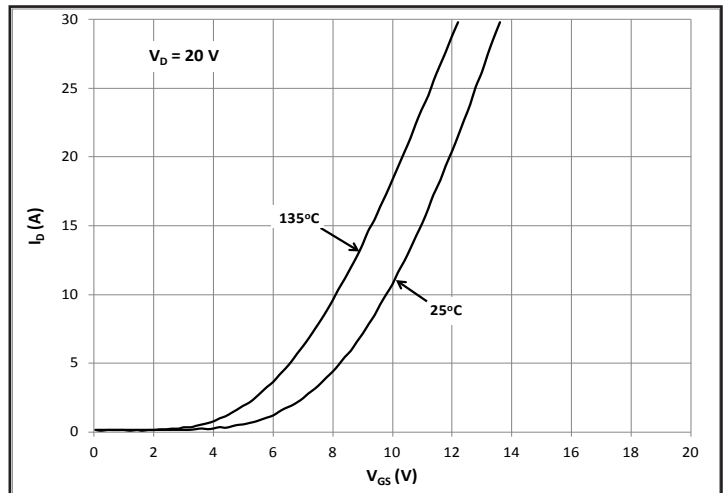

Figure 6. Typical Transfer Characteristics

Typical Performance

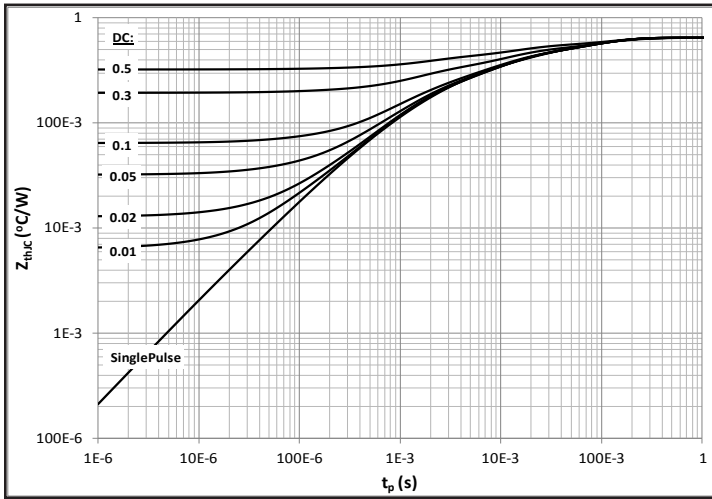

Figure 7. Transient Thermal Impedance (Junction - Case) with Duty Cycle

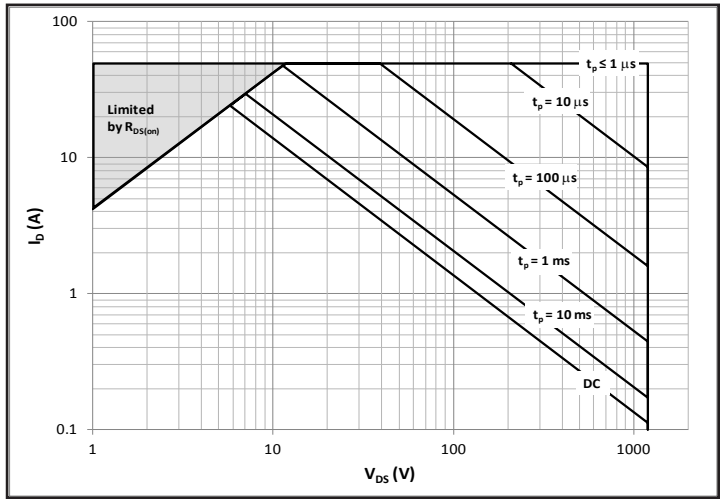

Figure 8. Safe Operating Area

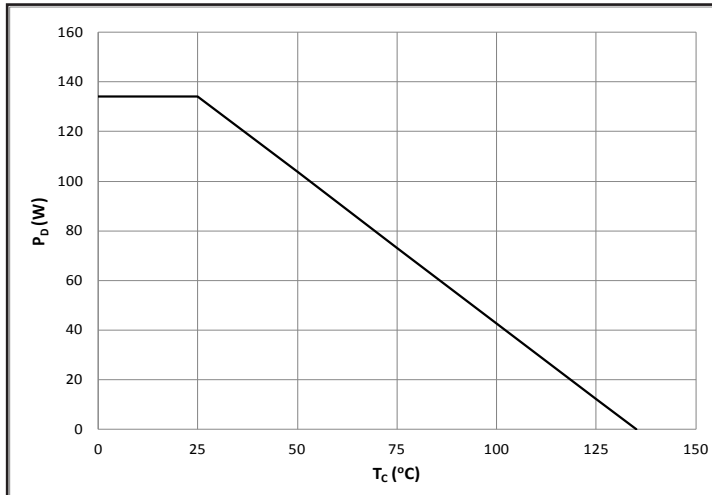

Figure 9. Power Dissipation Derating Curve

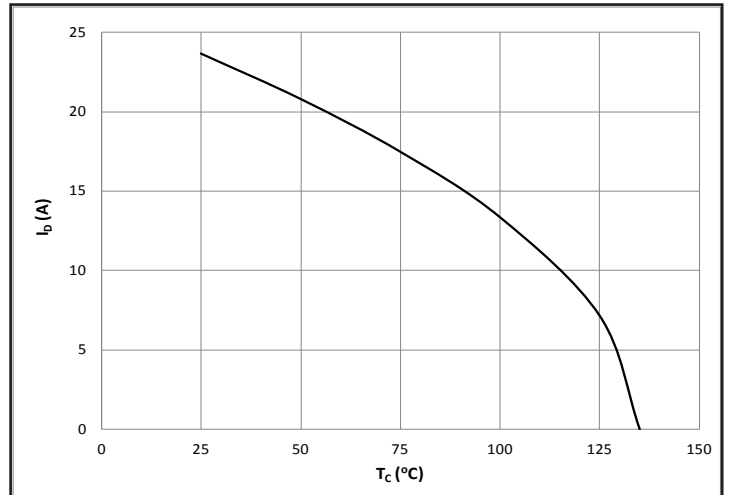

Figure 10. Continuous Current Derating Curve

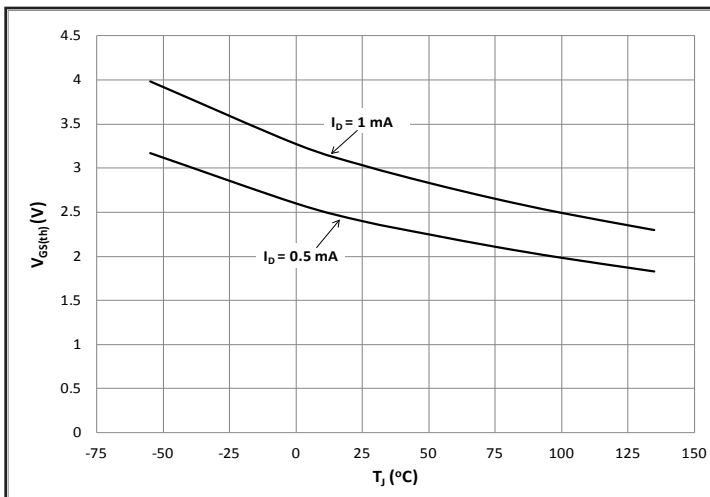

Figure 11. Gate Threshold Voltage vs. Temperature

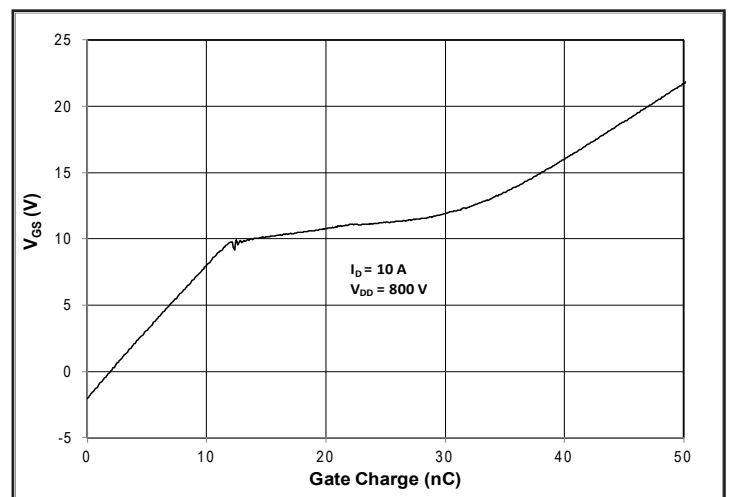

Figure 12. Typical Gate Charge Characteristics (25°C)

Typical Performance

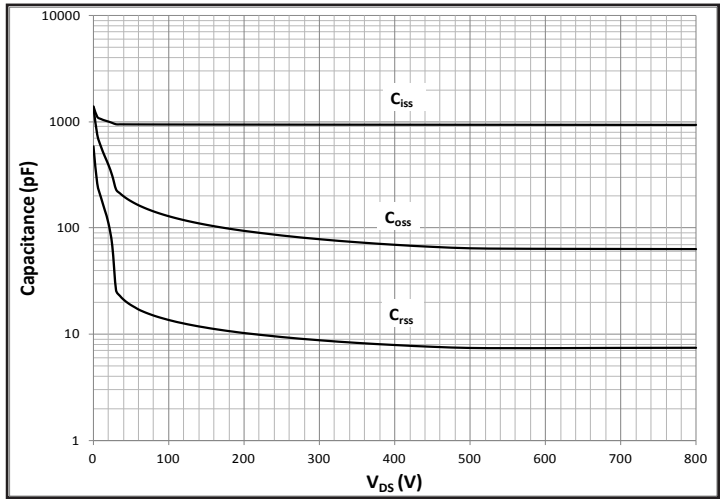
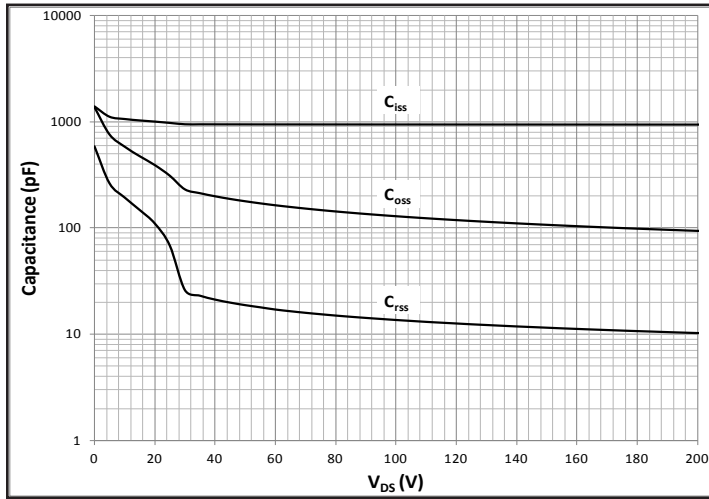

Figure 13A and 13B. Typical Capacitances vs. Drain Voltage at $V_{GS} = 0V$ and $f = 1\text{ MHz}$

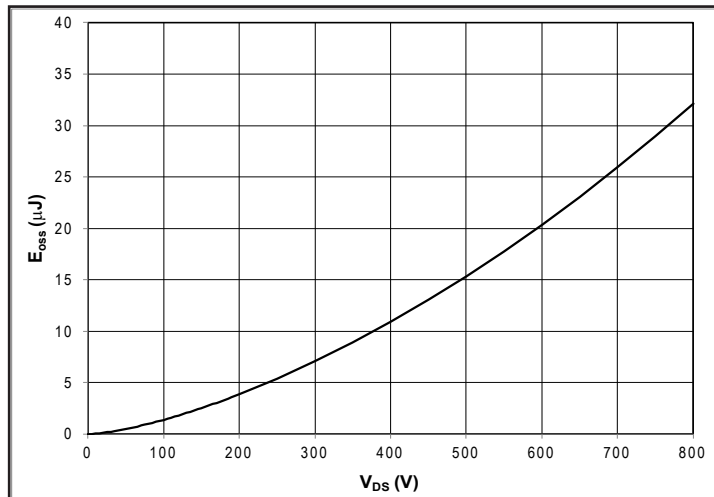

Figure 14. Typical C_{OSS} Stored Energy

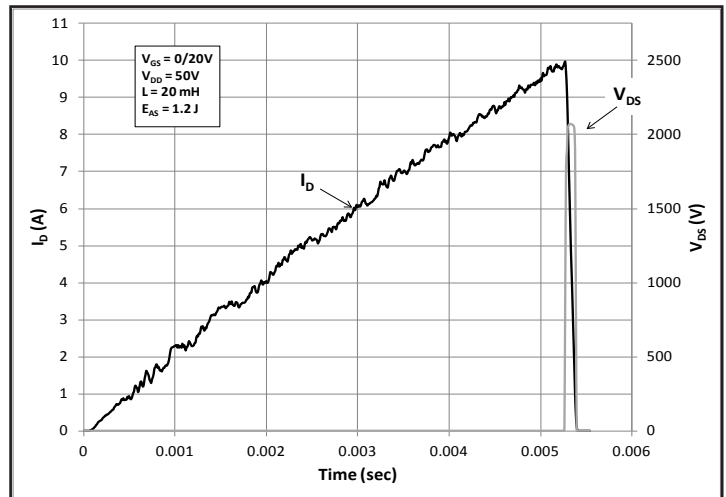

Figure 15. Typical Unclamped Inductive Switching Waveforms Showing Avalanche Capability

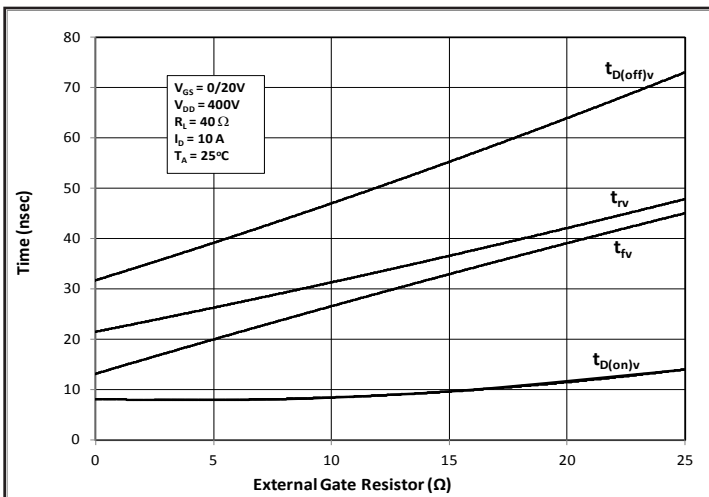

Figure 16. Resistive Switching Times vs. External R_G at $V_{DD} = 400V$, $I_D = 10A$

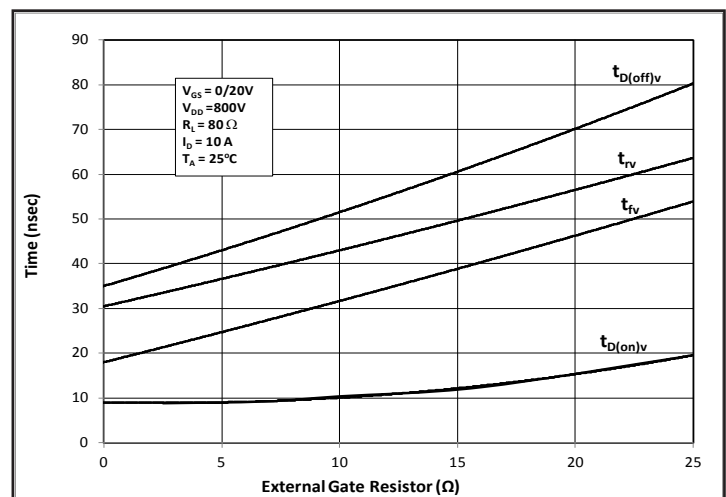

Figure 17. Resistive Switching Times vs. External R_G at $V_{DD} = 800V$, $I_D = 10A$

Typical Performance

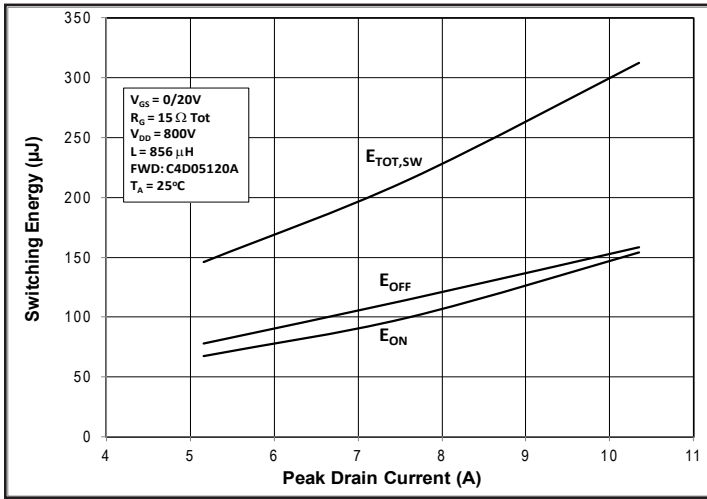

Figure 18. Clamped Inductive Switching Energy vs. Drain Current (Fig. 20)

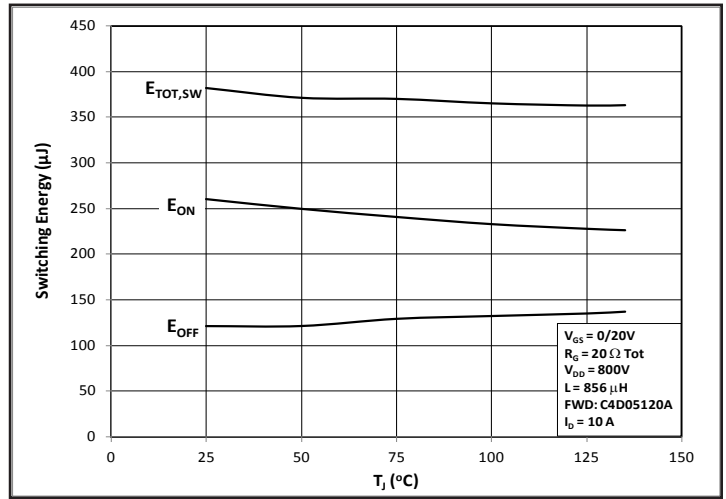

Figure 19. Clamped Inductive Switching Energy vs. Junction Temperature (Fig. 20)

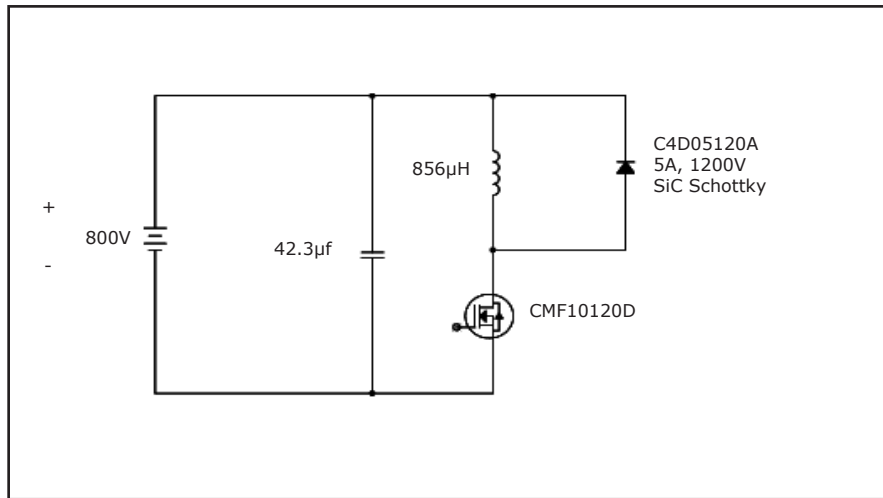

Figure 20. Clamped Inductive Switching Waveform Test Circuit

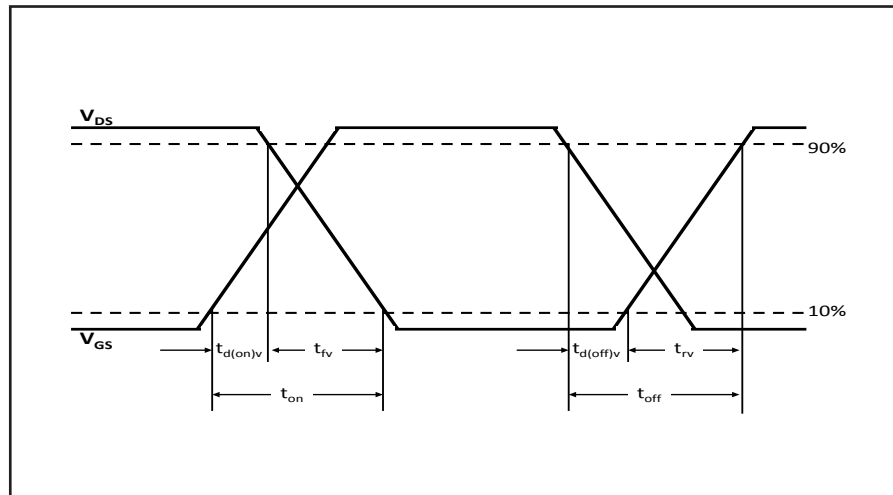

Figure 21. Switching Test Waveforms for Transition times

Test Circuit Diagrams and Waveforms

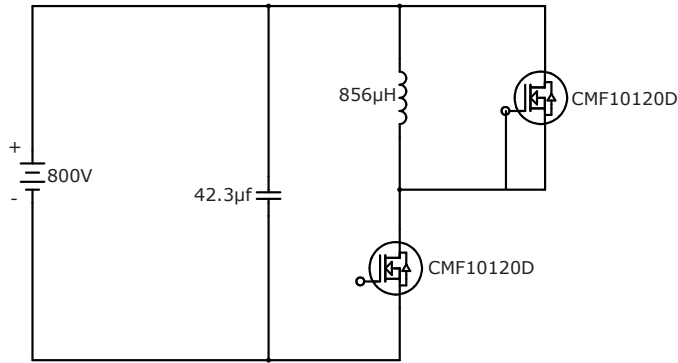

Fig 22. Body Diode Recovery Test

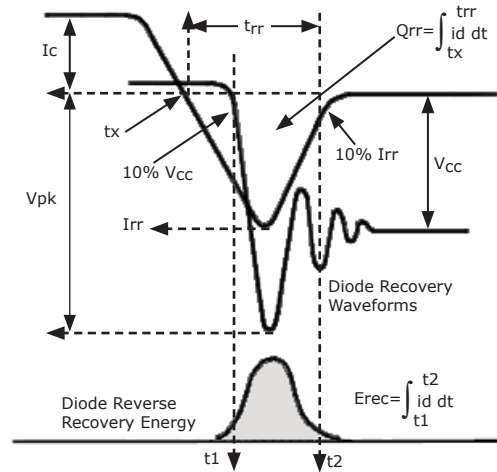

Fig 23. Body Diode Recovery Waveform

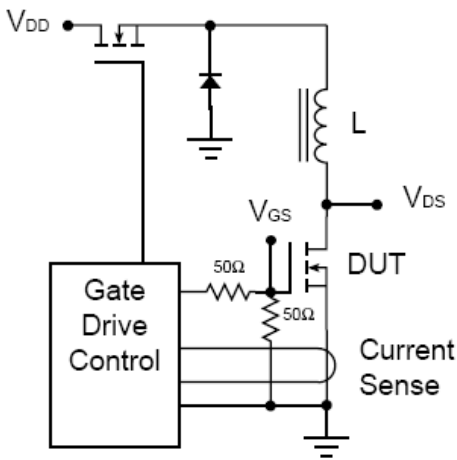

Fig 24. Unclamped Inductive Switching Test Circuit

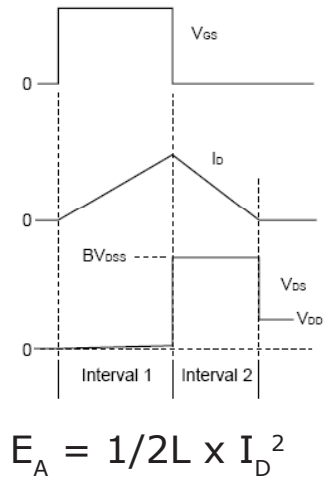

Fig 25. Unclamped Inductive Switching waveform for Avalanche Energy

ESD Ratings

ESD Test	Total Devices Sampled	Resulting Classification
ESD-HBM	All Devices Passed 1000V	2 (>2000V)
ESD-MM	All Devices Passed 400V	C (>400V)
ESD-CDM	All Devices Passed 1000V	IV (>1000V)

Package Dimensions

Package TO-247-3

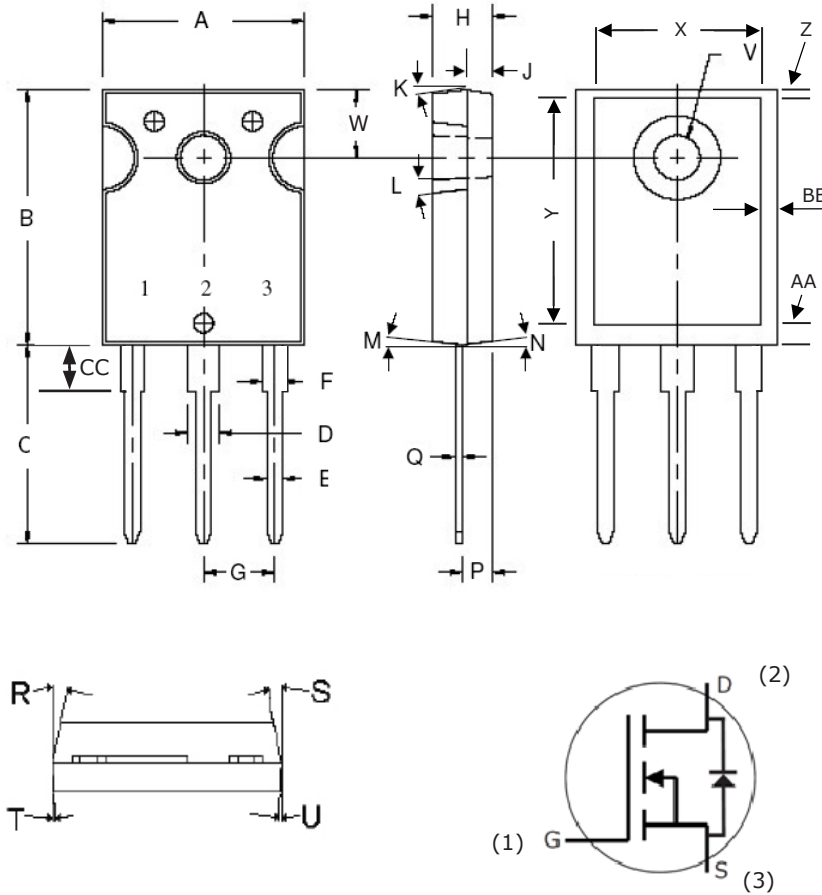

POS	Inches		Millimeters	
	Min	Max	Min	Max
A	.605	.635	15.367	16.130
B	.800	.831	20.320	21.10
C	.780	.800	19.810	20.320
D	.095	.133	2.413	3.380
E	.046	.052	1.168	1.321
F	.060	.095	1.524	2.410
G	.215 TYP		5.460 TYP	
H	.175	.205	4.450	5.210
J	.075	.085	1.910	2.160
K	6°	21°	6°	21°
L	4°	6°	4°	6°
M	2°	4°	2°	4°
N	2°	4°	2°	4°
P	.090	.100	2.286	2.540
Q	.020	.030	.508	.762
R	9°	11°	9°	11°
S	9°	11°	9°	11°
T	2°	8°	2°	8°
U	2°	8°	2°	8°
V	.137	.144	3.487	3.658
W	.210	.248	5.334	6.300
X	.502	.557	12.751	14.150
Y	.637	.695	16.180	17.653
Z	.038	.052	0.964	1.321
AA	.110	.140	2.794	3.556
BB	.030	.046	0.766	1.168
CC	.161	.176	4.100	4.472

Recommended Solder Pad Layout

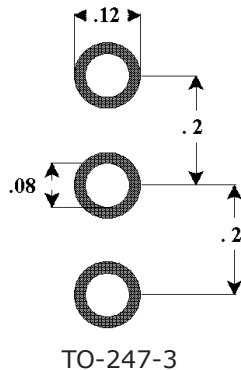

Part Number	Package	Marking
CMF10120D	TO-247-3	CMF10120

"The levels of environmentally sensitive, persistent biologically toxic (PBT), persistent organic pollutants (POP), or otherwise restricted materials in this product are below the maximum concentration values (also referred to as the threshold limits) permitted for such substances, or are used in an exempted application, in accordance with EU Directive 2002/95/EC on the restriction of the use of certain hazardous substances in electrical and electronic equipment (RoHS), as amended through April 21, 2006.

This product has not been designed or tested for use in, and is not intended for use in, applications implanted into the human body nor in applications in which failure of the product could lead to death, personal injury or property damage, including but not limited to equipment used in the operation of nuclear facilities, life-support machines, cardiac defibrillators or similar emergency medical equipment, aircraft navigation or communication or control systems, air traffic control systems, or weapons systems.

Copyright © 2010-2012 Cree, Inc. All rights reserved. The information in this document is subject to change without notice. Cree and the Cree logo are registered trademarks and Z-REC and Z-FET are trademarks of Cree, Inc.

Cree, Inc.
4600 Silicon Drive
Durham, NC 27703
USA Tel: +1.919.313.5300
Fax: +1.919.313.5451
www.cree.com/power

Mouser Electronics

Authorized Distributor

Click to View Pricing, Inventory, Delivery & Lifecycle Information:

[Cree, Inc.:](#)

[CMF10120D](#)