



TSH150 AND TSH151 DEMOBOARD

by G. AUGUSTONI

INTRODUCTION

TSH150 and TSH151 are very high speed voltage feedback operational amplifiers, using STMicroelectronics BiCMOS process. They feature a 200V/ μ s slew rate, 150MHz gain bandwidth product and 20ns to 70ns settling time to 0.1% (2V step). The TSH151 has the added advantage of MOS inputs.

A 45° typical phase margin, for unity gain, makes them easy to use as followers for buffer applications with 50 Ω loads for example.

Additional information may be obtained from the respective data sheets.

A demonstration board is available for device evaluation (order code SLDB-001A).

This note illustrates how to use this demoboard and gives some results obtained from a few basic configurations.

PCB DESIGN

Building a board using the TSH150 and TSH151 does not require specific calculation but a few basic rules must be observed in order to obtain the best dynamic performances and avoid instability problems.

Use a good ground plane or common return point for power and signals. All tracks must be wide and as short as possible, this is in order to minimize parasitic resistance, capacitance and signal coupling. Pay special attention to the operational amplifier negative input parasitic capacitance, so as not to degrade speed performance. Parasitic capacitance cannot be totally eliminated therefore use small resistor values to reduce time constants formed with parasitic components.

For power supply decoupling use 10 μ F tantalum capacitors and 10nF ceramic placed very close to the device supply pins.

SCHEMATIC DIAGRAM

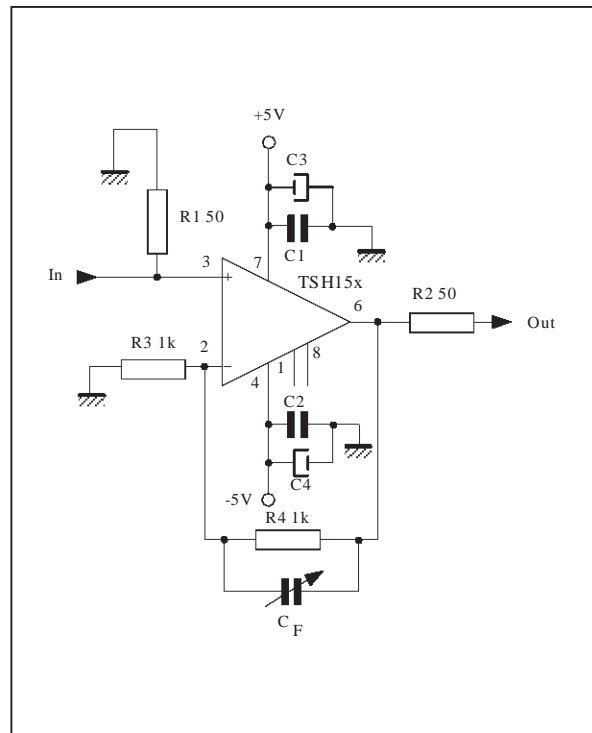

CIRCUIT BOARD LAYOUT

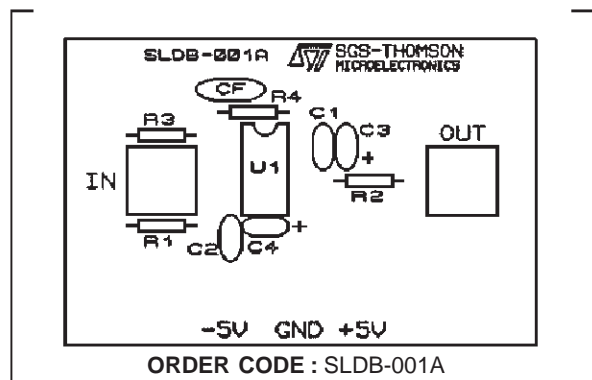

TECHNICAL NOTE

PCB

Figure 1 - SOLDER SIDE (1/1)

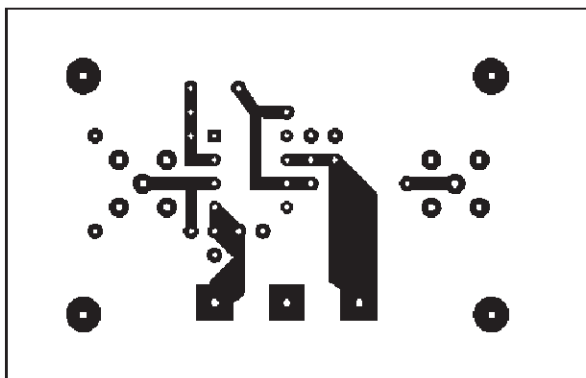
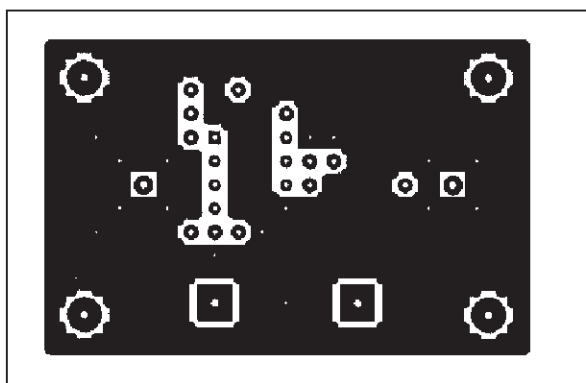

Figure 2 - COMPONENTS SIDE (1/1)



SLDB-001

This demoboard has been designed to show the performances of the THS150 and TSH151 in very simple configurations. The PCB is of a standard Epoxy glass type requiring 1/4 watt resistors, 2.54mm pitch capacitors and SMA or SMB 50Ω impedance connectors for the input and output.

The input impedance can be selected with R1 and the output impedance with R2. The whole circuit gives an amplifying stage with gain of $1 + \frac{R4}{R3}$.

MEASUREMENTS

For all the measurements, R1 = 50Ω, R2 = 50Ω and the following test equipments with 50Ω input mode have been used. (Note there is a 6dB loss due to a resistor bridge formed with R2 and the test equipment input which is corrected on each diagram).

- HP54100A Digitizing scope 1GHz bandwidth
- HP8160A Pulse generator 3ns rise time
- HP3577A Network analyser 5Hz - 200MHz

A 6dB AMPLIFYING STAGE

R3 = 1kΩ, R4 = 1kΩ

The first measurement was performed by applying a 4MHz 2Vpp square wave to the input. The following are the oscilloscope traces. For both devices, see figures 3 and 4. On Figure 4 (TSH151) there is a 15% overshoot and on Figure 3 (THS150) there is a 5% overshoot. Slew rate performances are the same for both 200V/μs, but the settling time is much shorter for TSH150.

Figure 3 - TSH150

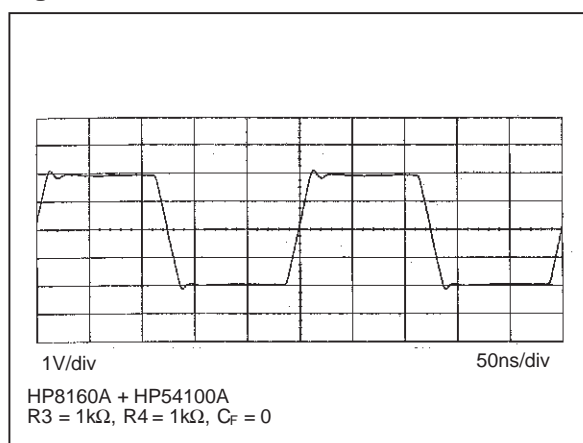
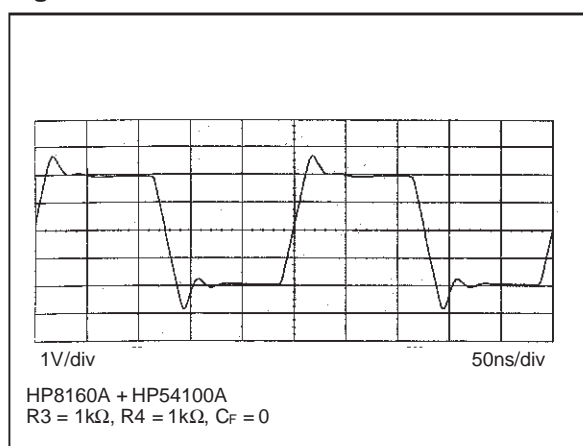

Figure 4 - TSH151



The result can be improved by reducing the values R3 and R4 or by adding a few pF of feedback capacitance C_F, adjusted to minimize settling time and overshoot.

C_F is used to compensate unavoidable parasitic input capacitance by introducing a zero to cancel the pole formed by the input RC network. Figures 5 and 6 show the overshoot reduction and settling time improvement without a change in slew rate.

Figure 5 - TSH150

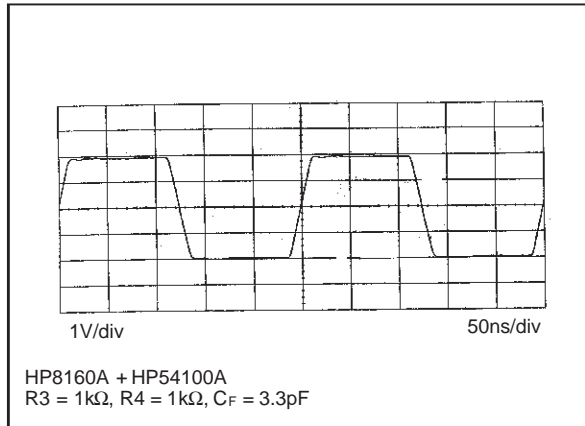
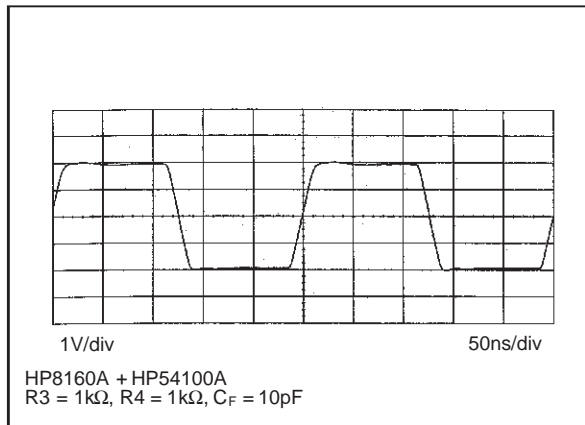

Figure 6 - TSH151



FREQUENCY RESPONSE

Changing the value of R3 from 1kΩ to 10Ω gives a 40dB amplifying stage. Note that for high gain, C_F is now redundant since R3 is very small. The following wellknown curves show the frequency response, gain bandwidth product and phase margin for both devices (figure 7 and 8). One can observe the 47° phase margin for 0dB gain at 150MHz for the TSH150 and a 43° phase margin for 0dB gain at 80MHz for the TSH151 (markers). The gain bandwidth product of the TSH151 is specified at 7.5MHz with 26dB of open loop gain.

HIGH SPEED BUFFER

It can be seen in figure 7 and 8 that a good phase margin exists for both operational amplifiers with unity gain. Therefore, it is possible to use them as followers for high speed buffer applications i.e. cable line drivers. Shorting R4 and removing R3

Figure 7 - TSH150

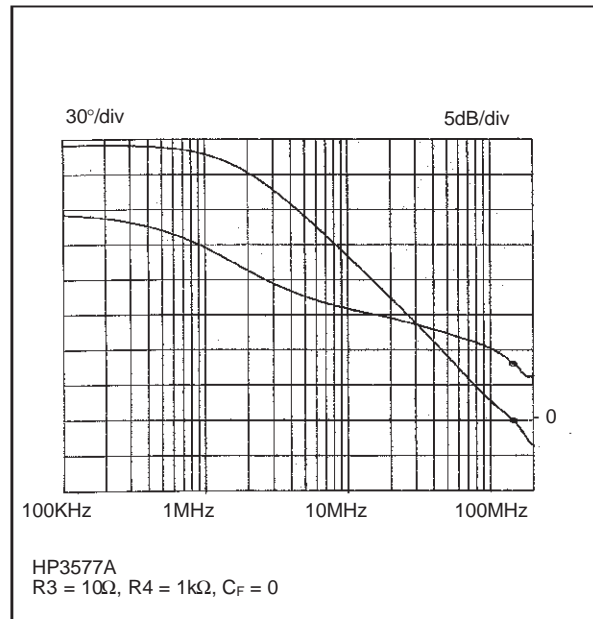
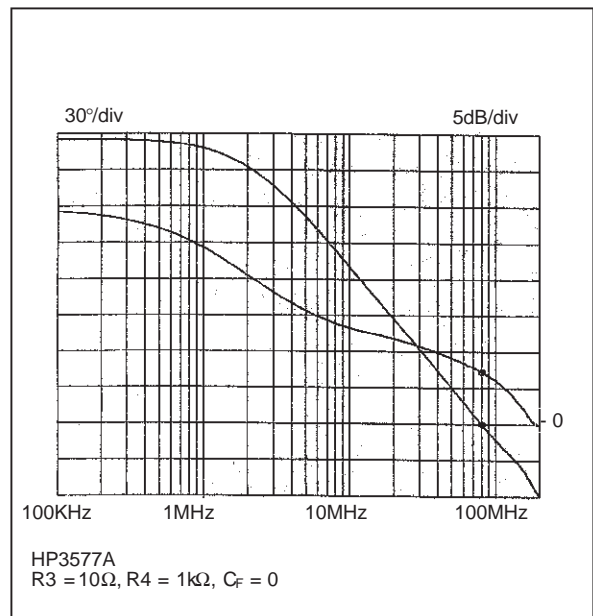

Figure 8 - TSH151



TECHNICAL NOTE

gives a follower configuration (a follower is the worst case in terms of circuit stability, since the SLDB-001 PCB demoboard was not designed for this type of configuration and this results in a small oscillation when the TSH150 is used. To avoid

these oscillations, the connection between the output and the inverting input must be direct and short). Figures 9 and 10 show the response to a 20MHz 1Vpp square wave.

Figure 9 - TSH150

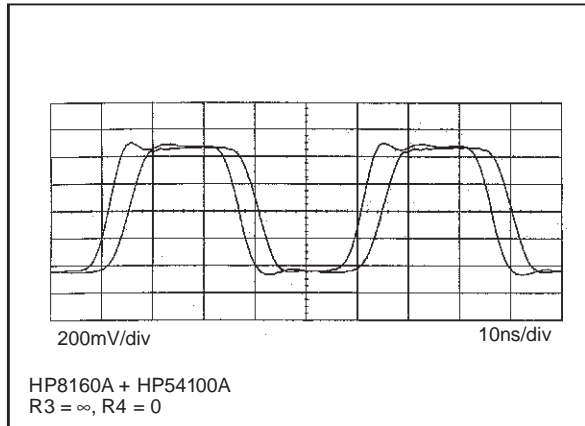
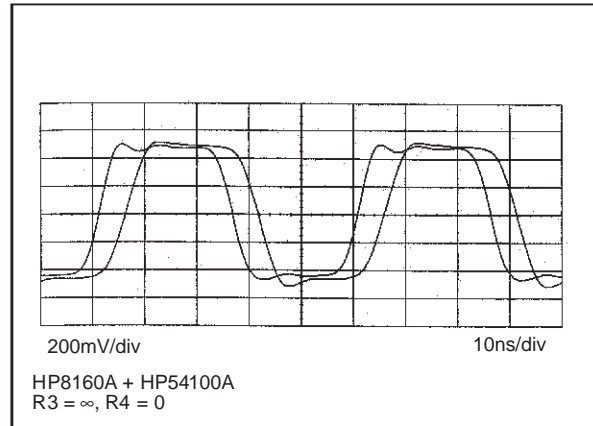

Figure 10 - TSH151



Information furnished is believed to be accurate and reliable. However, STMicroelectronics assumes no responsibility for the consequences of use of such information nor for any infringement of patents or other rights of third parties which may result from its use. No license is granted by implication or otherwise under any patent or patent rights of STMicroelectronics. Specifications mentioned in this publication are subject to change without notice. This publication supersedes and replaces all information previously supplied. STMicroelectronics products are not authorized for use as critical components in life support devices or systems without express written approval of STMicroelectronics.

© The ST logo is a trademark of STMicroelectronics

© 1999 STMicroelectronics – Printed in Italy – All Rights Reserved

STMicroelectronics GROUP OF COMPANIES

Australia - Brazil - Canada - China - France - Germany - Italy - Japan - Korea - Malaysia - Malta - Mexico - Morocco
The Netherlands - Singapore - Spain - Sweden - Switzerland - Taiwan - Thailand - United Kingdom - U.S.A.

© <http://www.st.com>