

KSH5027F

SemiHow
Know-How for Semiconductor

KSH5027F

High Voltage and High Reliability

- High Speed Switching
- Wide SOA

Absolute Maximum Ratings TC=25°C unless otherwise noted

3 Amperes
NPN Silicon Power Transistor
50 Watts

CHARACTERISTICS	SYMBOL	RATING	UNIT
Collector-Base Voltage	V_{CBO}	1100	V
Collector-Emitter Voltage	V_{CEO}	800	V
Emitter-Base Voltage	V_{EBO}	7	V
Collector Current(DC)	I_C	3	A
Collector Current(Pulse)	I_{CP}	10	A
Base Current	I_B	1.5	A
Collector Dissipation(Tc=25°C)	P_C	40	W
Junction Temperature	T_J	150	°C
Storage Temperature	T_{STG}	-55~150	°C

TO-220F
1. Base
2. Collector
3. Emitter

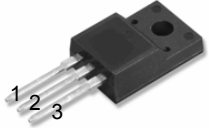

Electrical Characteristics TC=25°C unless otherwise noted

CHARACTERISTICS	SYMBOL	Test Condition	Min	Typ.	Max	Unit
Collector-Base Breakdown Voltage	V_{CBO}	$I_C=1mA, I_E=0$	1100			V
Collector-Emitter Breakdown Voltage	V_{CEO}	$I_C=5mA, I_B=0$	800			V
Emitter-Base Breakdown Voltage	V_{EBO}	$I_E=1mA, I_C=0$	7			V
Collector-Emitter Sustaining Voltage	$I_{CEX(sus)}$	$I_C=1.5A, I_{B1}=-I_{B2}=0.3A$ $L=2mH, \text{Clamped}$	800			V
Collector Cutoff Current	I_{CBO}	$V_{CB}=800V, I_E=0$			10	μA
Emitter Cutoff Current	I_{EBO}	$V_{EB}=5V, I_C=0$			10	μA
DC Current Gain	h_{FE1} h_{FE2}	$V_{CE}=5V, I_C=0.2A$ $V_{CE}=5V, I_C=1A$	10 8		40	
Collector-Emitter Saturation Voltage	$V_{CE(sat)}$	$I_C=1.5A, I_B=0.3A$			2	V
Base-Emitter Saturation Voltage	$V_{BE(sat)}$	$I_C=1.5A, I_B=0.3A$			1.5	V
Output Capacitance	C_{ob}	$V_{CB}=10V, I_E=0, f=0.1MHz$		60		pF
Current Gain Bandwidth Product	f_T	$V_{CE}=10V, I_C=0.2A$		15		MHz
Turn on Time	t_{on}	$V_{CC}=400V, I_C=5A$ $I_{B1}=-2.5A, I_{B2}=2A$ $R_L=200\Omega$			0.5	μs
Storage Time	t_{stg}				3.0	μs
Fall Time	t_f				0.3	μs

Note : h_{FE1} Classification R : 10 ~ 20, O : 15 ~ 30, Y : 20 ~ 40

Typical Characteristics

Figure 1. Static Characteristic

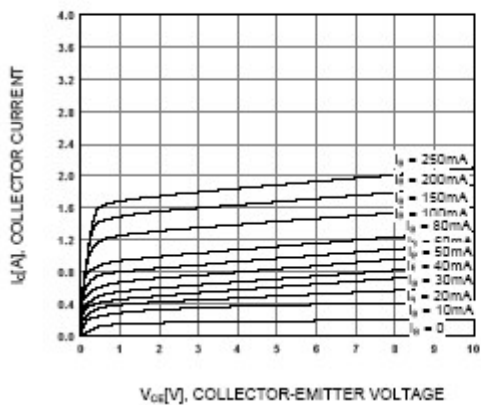

Figure 2. DC current Gain

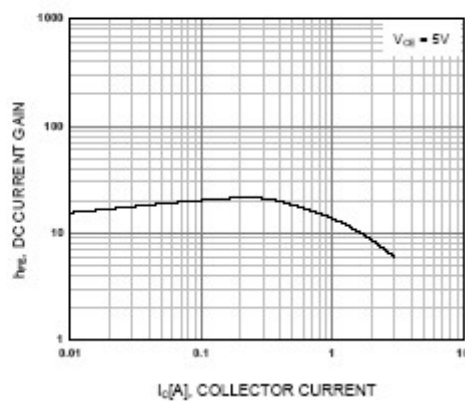

Figure 3. Base-Emitter Saturation Voltage
Collector-Emitter Saturation

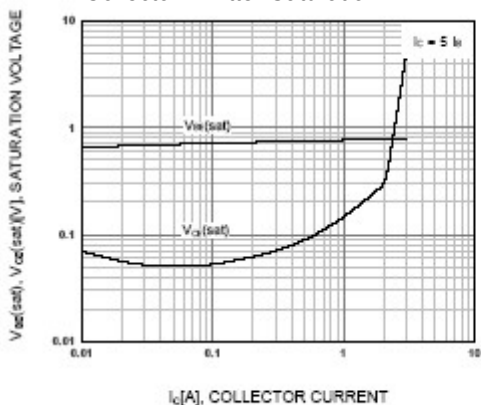

Figure 4. Base-Emitter On Voltage

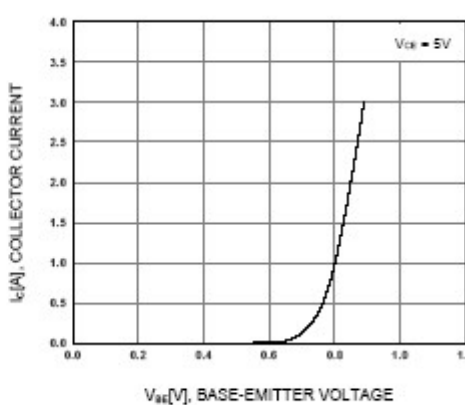

Figure 5. Switching Time

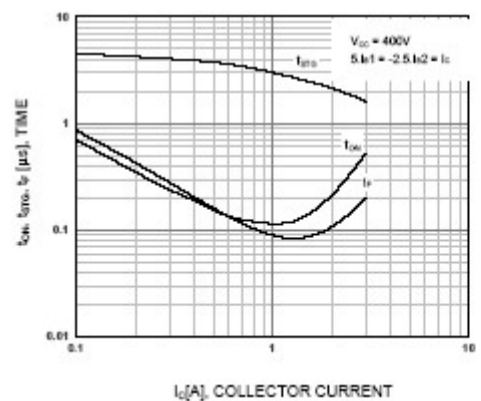
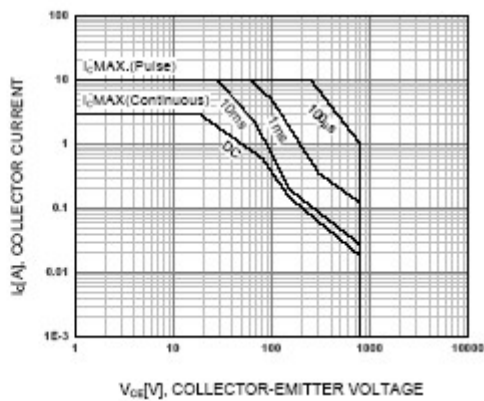

Figure 6. Safe Operating Area



Typical Characteristics (Continued)

Figure 7. Reverse Bias Operating Area

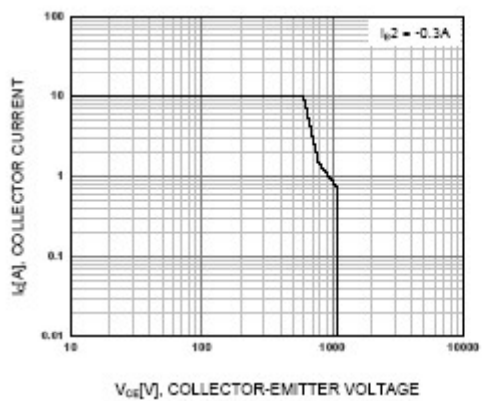
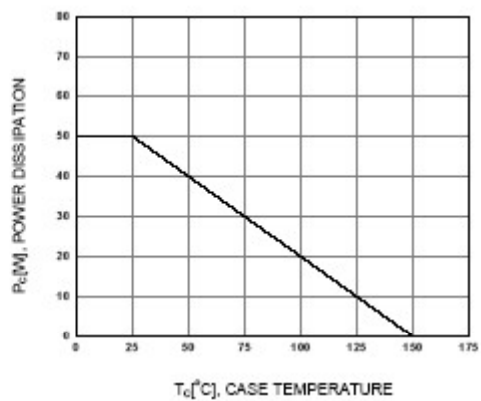
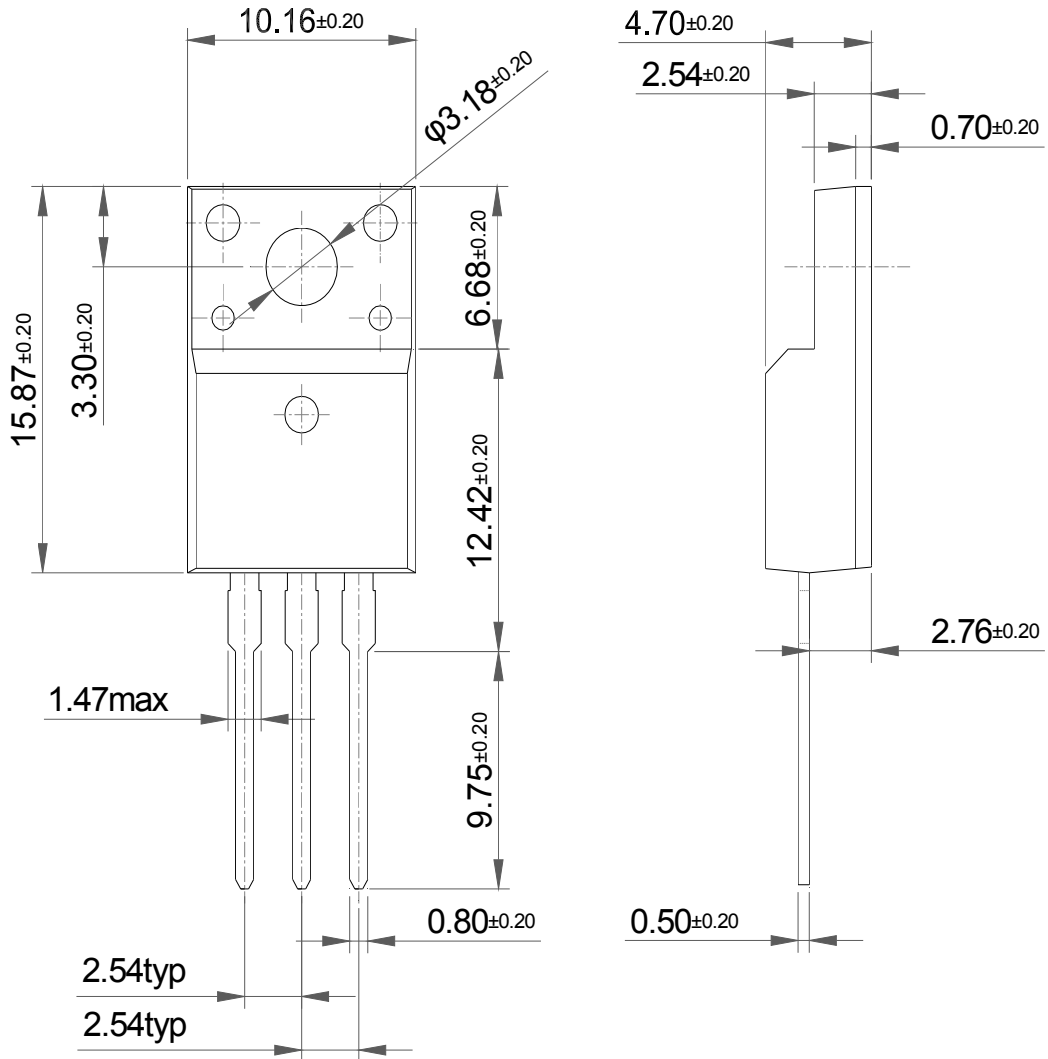

Figure 8. Power Derating



Package Dimension

TO-220F



Dimensions in Millimeters