

# BG20A

## 5-800 MHz Internally Matched IF Amplifier



### Device Features

- OIP3 = 39.0 dBm @ 70 MHz
- Gain = 24 dB @ 70 MHz
- Output P1 dB = 20.5 dBm @ 70 MHz
- 50 Ω Cascadable
- Patented temperature compensation
- Lead-free/RoHS-compliant SOT-89 SMT package

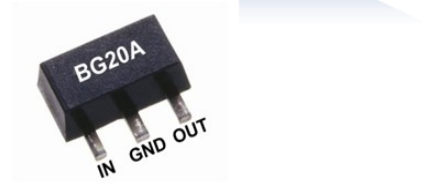

### Product Description

BeRex's BG20A is a high performance InGaP/ GaAs HBT MMIC amplifier, internally matched to 50 Ohms and uses a patented **temperature compensation** circuit to provide stable current over the operating temperature range without the need for external components. The BG20A is designed for high linearity IF amplifier that requires excellent gain, high OIP3 and flatness. It is packaged in a RoHS-compliant with SOT-89 surface mount package.

### Typical Performance<sup>1</sup>

Parameter	Frequency					Unit
	70	140	250	500	800	
Gain	24.0	23.9	23.7	23.1	22.3	dB
S11	-19.5	-21.2	-22.0	-26.0	-30	dB
S22	-12.5	-13.0	-13.0	-12.0	-9.4	dB
OIP3 <sup>2</sup>	39.0	37.0	37.0	36.0	33.0	dBm
P1dB	20.5	20.5	20.5	20.5	20.3	dBm
Noise Figure	3.4	3.4	3.5	3.6	3.6	dB

<sup>1</sup> Device performance \_ measured on a BeRex evaluation board at 25°C, 50 Ω system.

<sup>2</sup> OIP3 \_ measured with two tones at an output of 10 dBm per tone separated by 1 MHz.

### Applications

- Base station Infrastructure/RFID
- Commercial/Industrial/Military wireless system

### Applications Circuit

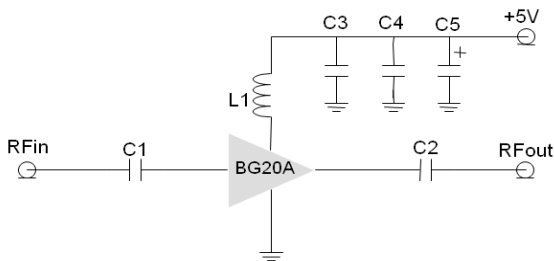

\*C1, C2=2700pF ± 5%; C3 = 100 pF ± 5%; C4 = 1000pF ± 5%

\*C5 = 10uF; L1 = 470nH ± 5%

	Min.	Typical	Max.	Unit
Bandwidth	5		800	MHz
I <sub>c</sub> @ (V <sub>c</sub> = 5V)	80	90	100	mA
V <sub>c</sub>		5.0		V
dG/dT		-0.003		dB/°C
R <sub>TH</sub>		50		°C/W

### Absolute Maximum Ratings

Parameter	Rating	Unit
Operating Case Temperature	-40 to +85	°C
Storage Temperature	-55 to +155	°C
Junction Temperature	+220	°C
Operating Voltage	+6.5	V
Supply Current	200	mA
Input RF Power	23	dBm

Operation of this device above any of these parameters may result in permanent damage.

# BG20A

5-800 MHz Internally Matched IF Amplifier



## V-I Characteristics

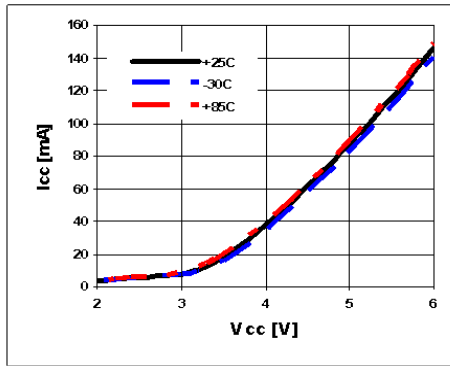

## BeRex SOT89 Evaluation Board

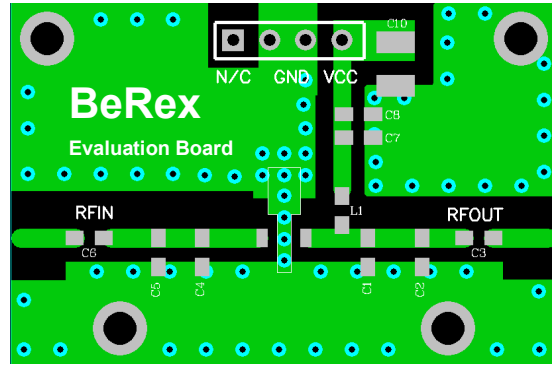

\*Dielectric constant \_ 4.2 \*RF pattern width 52mil \*31mil thick FR4 PCB

## Typical Device Data

S-parameters (Vc=5V, Ic=90mA, T=25°C)

CH1 LOG 10 dB/ REF 0 dB  
S11 2: -21.246 dB 140.000 000 MHz

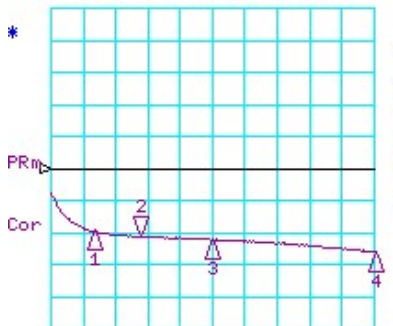

START 5.000 MHz STOP 500.000 MHz

CH3 LOG 10 dB/ REF 0 dB  
S13 2: -28.039 dB 140.000 000 MHz

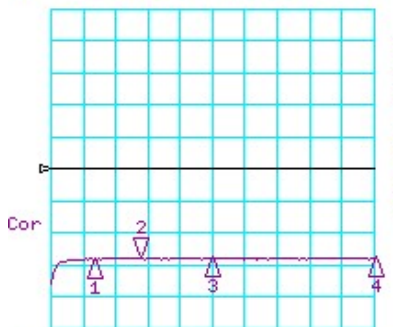

START 5.000 MHz STOP 500.000 MHz

CH2 LOG 10 dB/ REF 0 dB  
S31 2: 23.914 dB 140.000 000 MHz

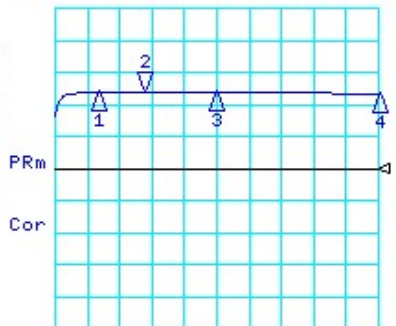

START 5.000 MHz STOP 500.000 MHz

CH4 LOG 10 dB/ REF 0 dB  
S33 2: -13.141 dB 140.000 000 MHz

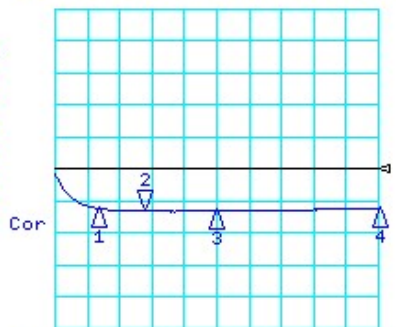

START 5.000 MHz STOP 500.000 MHz

CH2 Markers  
1: 23.841 dB  
70.000 MHz  
3: 23.800 dB  
250.000 MHz  
4: 23.435 dB  
500.000 MHz

CH4 Markers  
1: -12.323 dB  
70.000 MHz  
3: -13.148 dB  
250.000 MHz  
4: -12.185 dB  
500.000 MHz

# BG20A



## 5-800 MHz Internally Matched IF Amplifier

### S-Parameter

(Vdevice = 5.0V, Icc = 86mA, T = 25 °C, calibrated to device leads)

Freq [MHz]	S11 [Mag]	S11 [Ang]	S21 [Mag]	S21 [Ang]	S12 [Mag]	S12 [Ang]	S22 [Mag]	S22 [Ang]
10	0.331	-56.956	10.899	-130.684	0.027	51.642	0.666	138.145
50	0.124	-121.832	15.402	-175.255	0.039	8.389	0.274	50.493
100	0.094	-148.663	15.715	170.439	0.039	-2.297	0.229	17.022
150	0.085	-164.361	15.673	160.148	0.040	-9.520	0.220	-1.972
200	0.082	-173.639	15.667	150.953	0.040	-14.447	0.217	-15.671
250	0.077	179.776	15.488	142.474	0.039	-19.359	0.220	-26.966
300	0.073	174.971	15.506	133.989	0.040	-24.824	0.223	-36.438
350	0.068	169.602	15.220	125.499	0.040	-29.937	0.227	-45.740
400	0.062	165.033	15.275	117.646	0.039	-34.787	0.233	-54.264
450	0.056	160.728	14.921	108.985	0.040	-39.029	0.240	-61.890
500	0.049	155.970	14.851	101.860	0.040	-43.699	0.246	-68.880

Typical Performance (Vd = 5V, Vdevice\*=4.85V, Ic = 85mA, T = 25°C)

Freq	MHz	70	140	250	500	800
S21	dB	24.0	23.9	23.7	23.1	22.3
S11	dB	-19.5	-21.2	-22.0	-26.0	-30
S22	dB	-12.5	-13.0	-13.0	-12.0	-9.4
P1	dBm	20.5	20.5	20.5	20.5	20.3
OIP3	dBm	39.0	37.0	37.0	36.0	33
NF	dB	3.4	3.4	3.5	3.6	3.6

\*4.85V at the device is due to 0.15V drop across 470nH choke inductor.

# BG20A



## 5-800 MHz Internally Matched IF Amplifier

Typical Performance (Vd = 4.7V, Ic = 74mA, T = 25°C)

Freq	MHz	70	140	250	500	800
S21	dB	23.8	23.8	23.6	23	22.1
S11	dB	-22.5	-27.1	-30.9	-36	-25.4
S22	dB	-11.5	-12.3	-12.2	-10.5	-8.7
P1	dBm	19.5	19.9	20	19.9	19.3
OIP3	dBm	36	37	35.5	33	31
NF	dB	3.4	3.4	3.5	3.6	3.6

Typical Performance (Vd = 4.5V, Ic = 64mA, T = 25°C)

Freq	MHz	70	140	250	500	800
S21	dB	23.8	23.7	23.5	22.9	22
S11	dB	-23	-29.2	-35.4	-35.1	-24
S22	dB	-11.2	-11.9	-11.8	-10.2	-8.6
P1	dBm	18.3	18.3	18.3	18.3	18.2
OIP3	dBm	33.5	31.0	32.0	32.0	30.5
NF	dB	3.4	3.4	3.5	3.6	3.6

### Pin-Pout-Gain

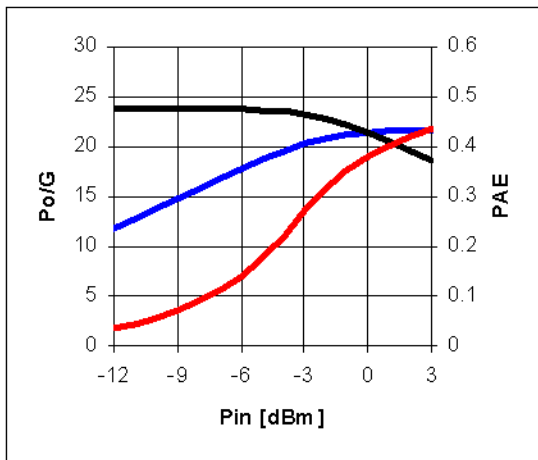

200MHz, 5V/86mA

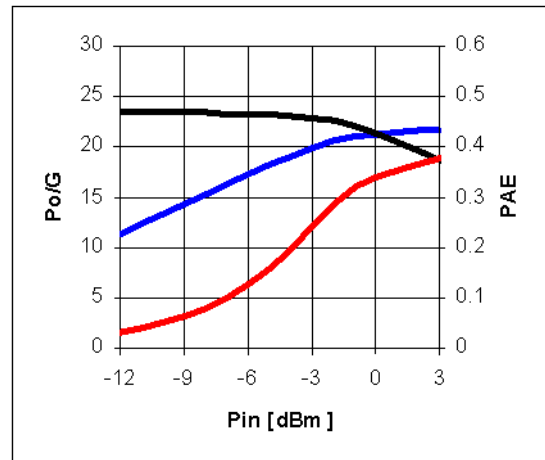

500 MHz, 5V/86mA

# BG20A

## 5-800 MHz Internally Matched IF Amplifier



### OIP3

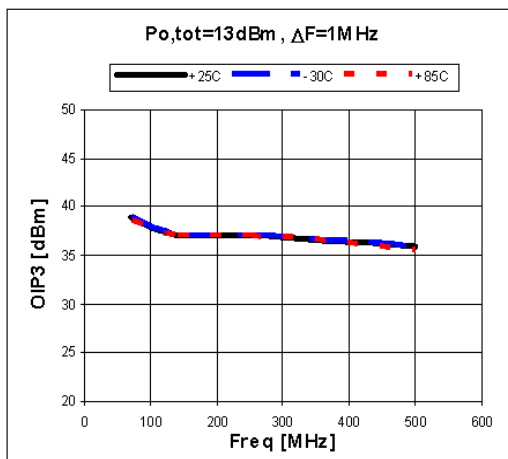
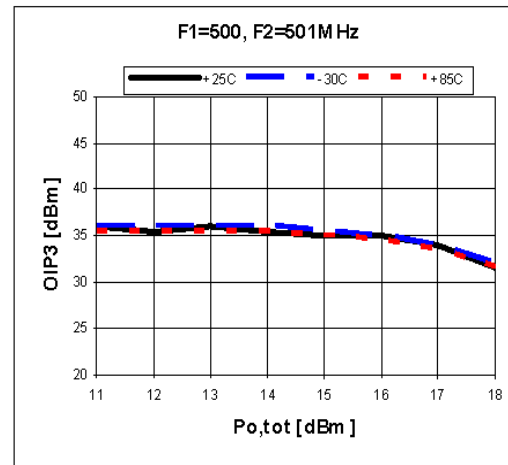
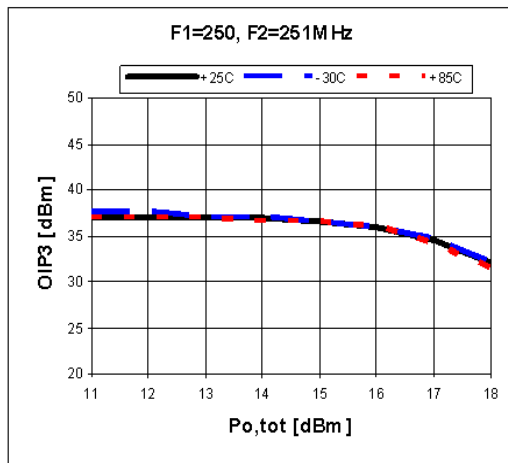
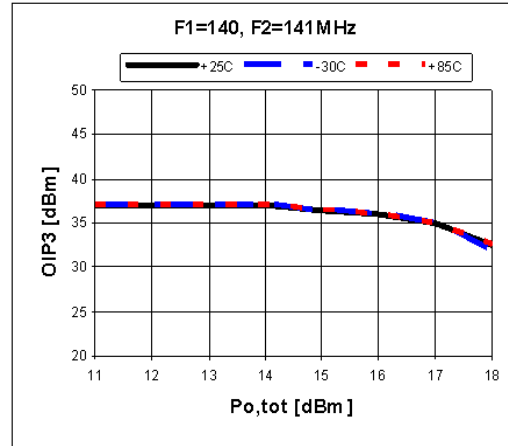
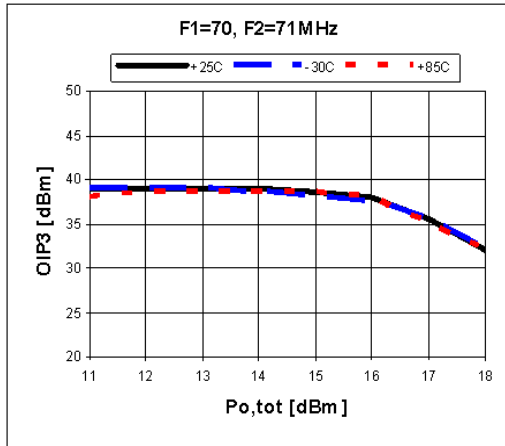

# BG20A

## 5-800 MHz Internally Matched IF Amplifier



### ACPR

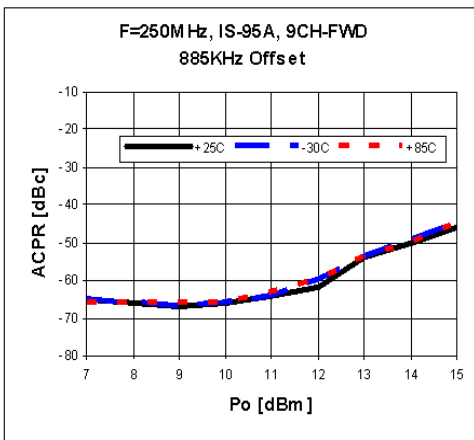
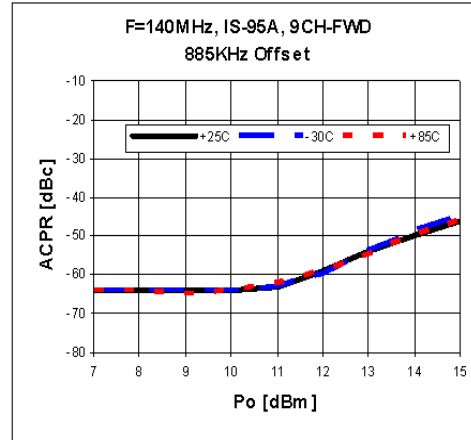
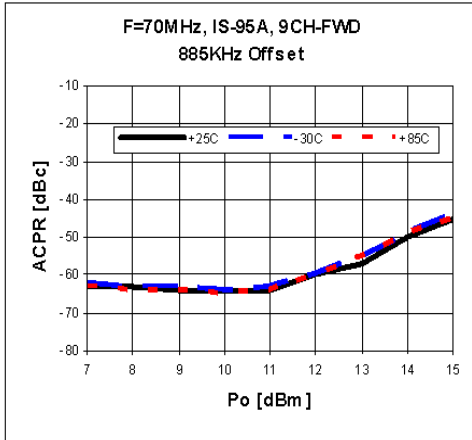

### ACLR

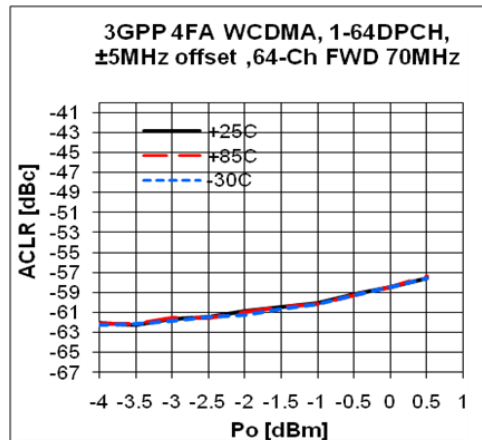

### Gain Flatness

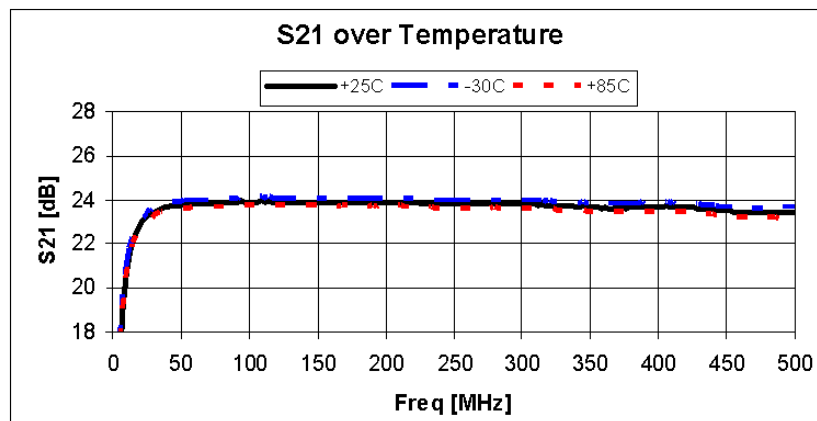

# BG20A

5-800 MHz Internally Matched IF Amplifier



## Package Outline Dimension

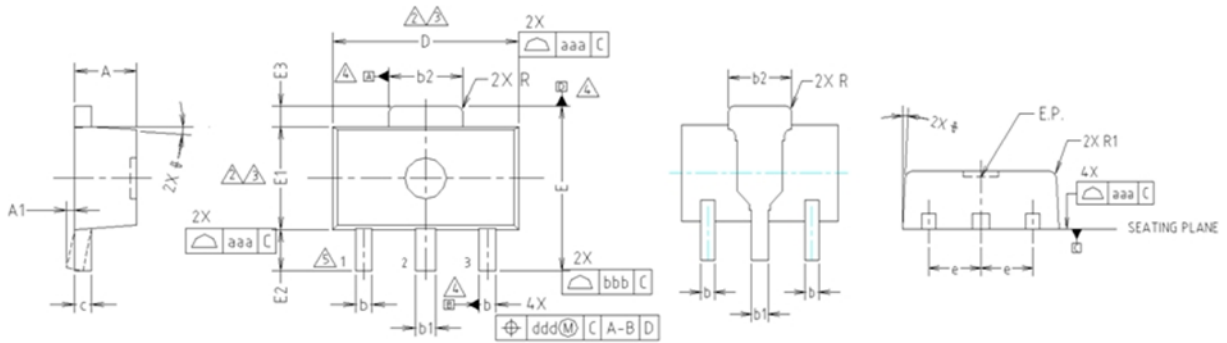

- NOTE:**  
 1. DIMENSIONS IN MILLIMETERS.
- ⚠ DIMENSION D DOES NOT INCLUDE MOLD FLASH, PROTRUSIONS OR GATE BURRS. MOLD FLASH, PROTRUSIONS OR GATE BURRS SHALL NOT EXCEED 0.5mm PER END. DIMENSION E1 DOES NOT INCLUDE INTERLEAD FLASH OR PROTRUSION. INTERLEAD FLASH OR PROTRUSION SHALL NOT EXCEED 0.5mm PER SIDE.
  - ⚠ DIMENSIONS D AND E1 ARE DETERMINED AT THE OUTMOST EXTREMES OF THE PLASTIC BODY EXCLUSIVE OF MOLD FLASH, TIE BAR BURRS, GATE BURRS AND INTERLEAD FLASH, BUT INCLUDING ANY MISMATCH BETWEEN THE TOP AND BOTTOM OF THE PLASTIC BODY.
  - ⚠ DATUMS A, B AND D TO BE DETERMINED 0.18mm FROM THE LEAD TIP.
  - ⚠ TERMINAL NUMBERS ARE SHOWN FOR REFERENCE ONLY.

SYMBOL	MILLIMETERS			NOTE
	MINIMUM	NOMINAL	MAXIMUM	
A	1.40	1.50	1.60	
A1	0.00	—	0.10	
b	0.38	0.42	0.48	
b1	0.48	0.52	0.58	
b2	1.79	1.82	1.87	
c	0.40	0.42	0.46	
D	4.40	4.50	4.70	2,3
E	3.70	4.00	4.30	
E1	2.40	2.50	2.70	2,3
E2	0.80	1.00	1.20	
E3	0.40	0.50	0.60	
e	1.50 TYP.			
φ	4° TYP.			
R	0.15 TYP.			
R1	—	—	0.20	
SYMBOL	TOLERANCES OF FORM AND POSITION		NOTE	
aaa	0.15			
bbb	0.20			
ccc	0.10			
ddd	0.10			

## Suggested PCB Land Pattern and PAD Layout

PCB Land Pattern

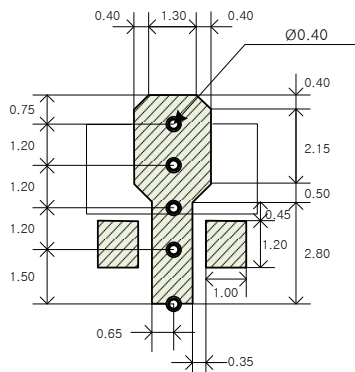

Note : All dimension \_ millimeters

PCB lay out \_ on BeRex website

PCB Mounting

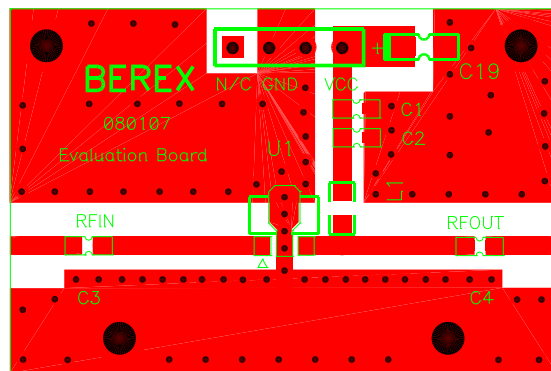

# BG20A

5-800 MHz Internally Matched IF Amplifier



## Tape & Reel

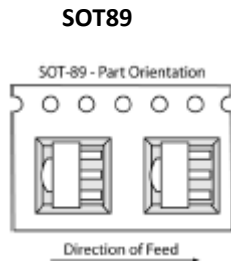

Packaging information:

Tape Width (mm): 12

Reel Size (inches): 7

Device Cavity Pitch (mm): 8

Devices Per Reel: 1000

## Lead plating finish

100% Tin Matte finish

(All BeRex products undergoes a 1 hour, 150 degree C, Anneal bake to eliminate thin whisker growth concerns.)

## MSL / ESD Rating

<b>ESD Rating:</b>	Class 1C
<b>Value:</b>	<b>Passes &lt;2000V</b>
<b>Test:</b>	Human Body Model (HBM)
<b>Standard:</b>	JEDEC Standard JESD22-A114B
<b>MSL Rating:</b>	<b>Level 1 at +265°C convection reflow</b>
<b>Standard:</b>	JEDEC Standard J-STD-020

## NATO CAGE code:

2	N	9	6	F
---	---	---	---	---