



Silicon Oscillator with Low-Power Frequency Switching

MAX7377

General Description

The MAX7377 dual-speed silicon oscillator with reset is a replacement for ceramic resonators, crystals, crystal oscillator modules, and discrete reset circuits. The device provides the primary and secondary clock source for microcontrollers in 3V, 3.3V, and 5V applications. The MAX7377 features a factory-programmed high-speed oscillator, a 32.768kHz oscillator, and a clock selector input. The clock output can be switched at any time between the high-speed clock and the 32.768kHz clock for low-power operation. Switchover is synchronized internally to provide glitch-free clock switching.

Unlike typical crystal and ceramic resonator oscillator circuits, the MAX7377 is resistant to vibration and EMI. The high-output-drive current and absence of high-impedance nodes make the oscillator less susceptible to dirty or humid operating conditions. With a wide operating temperature range as standard, the MAX7377 is a good choice for demanding home appliance, industrial, and automotive environments.

The MAX7377 is available in factory-programmed frequencies from 32.768kHz to 10MHz. See Table 1 for standard frequencies and contact the factory for custom frequencies.

The MAX7377 is available in a 5-pin SOT23 package. Refer to the MAX7383 data sheet for frequencies ≥ 10 MHz. The MAX7377 standard operating temperature range is -40°C to $+125^{\circ}\text{C}$. See the *Applications Information* section for the extended operating temperature range.

Applications

White Goods	Handheld Products
Automotive	Portable Equipment
Consumer Products	Microcontroller Systems
Appliances and Controls	

Typical Application Circuit appears at end of data sheet.

Features

- ◆ 2.7V to 5.5V Operation
- ◆ Accurate High-Speed 600kHz to 10MHz Oscillator
- ◆ Accurate Low-Speed 32kHz Oscillator
- ◆ Glitch-Free Switch Between High Speed and Low Speed at Any Time
- ◆ $\pm 10\text{mA}$ Clock-Output Drive Capability
- ◆ 2% Initial Accuracy
- ◆ $\pm 50\text{ppm}/^{\circ}\text{C}$ Temperature Coefficient
- ◆ 50% Duty Cycle
- ◆ 5ns Output Rise and Fall Time
- ◆ Low Jitter: 160ps(p-p) at 8MHz (No PLL)
- ◆ 3mA Fast-Mode Operating Current (8MHz)
- ◆ 13 μA Slow-Mode Operating Current (32kHz)
- ◆ -40°C to $+125^{\circ}\text{C}$ Temperature Range

Ordering Information

PART	TEMP RANGE	PIN-PACKAGE
MAX7377AX_-T	-40°C to $+125^{\circ}\text{C}$	5 SOT23-5

The first two letters are AX. See Table 1 at the end of the data sheet for the two-letter code.

Pin Configuration

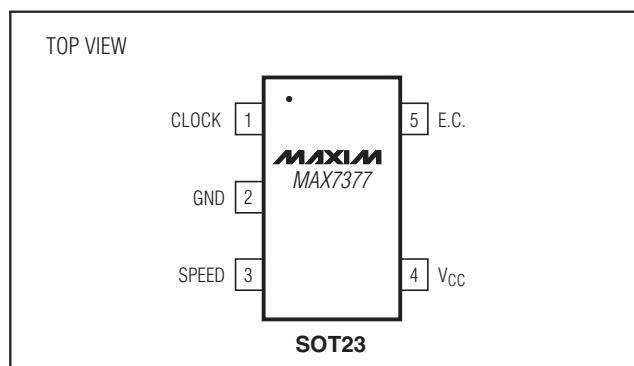

Silicon Oscillator with Low-Power Frequency Switching

ABSOLUTE MAXIMUM RATINGS

V_{CC} to GND-0.3V to +6V
 All Other Pins to GND-0.3V to (V_{CC} + 0.3V)
 CLOCK Current±10mA
 Continuous Power Dissipation (T_A = +70°C)
 5-Pin SOT23
 (derate 7.1mW/°C above +70°C)571mW (U5 - 2)

Operating Temperature Range-40°C to +135°C
 Junction Temperature+150°C
 Storage Temperature Range.....-60°C to +150°C
 Lead Temperature (soldering, 10s).....+300°C

Stresses beyond those listed under "Absolute Maximum Ratings" may cause permanent damage to the device. These are stress ratings only, and functional operation of the device at these or any other conditions beyond those indicated in the operational sections of the specifications is not implied. Exposure to absolute maximum rating conditions for extended periods may affect device reliability.

ELECTRICAL CHARACTERISTICS

(V_{CC} = 2.7V to 5.5V, T_A = -40°C to +125°C, unless otherwise noted. Typical values are at V_{CC} = 5V and T_A = +25°C.) (Note 1)

PARAMETER	SYMBOL	CONDITIONS	MIN	TYP	MAX	UNITS
Operating Supply Voltage	V _{CC}		2.7		5.5	V
Operating Supply Current	I _{CC}	f _{CLOCK} = 8MHz, no load		3	5	mA
		f _{CLOCK} = 32.768kHz, no load		13	25	µA
LOGIC INPUT (SPEED)						
Input High Voltage	V _{IH}		0.7 x V _{CC}			V
Input Low Voltage	V _{IL}				0.3 x V _{CC}	V
Input Current	I _{IN}				2	µA
CLOCK OUTPUT						
Output High Voltage	V _{OH}	V _{CC} = 4.5V, I _{SOURCE} = 9mA	V _{CC}		-0.4	V
		V _{CC} = 2.7V, I _{SOURCE} = 2.5mA	V _{CC}		-0.4	
Output Low Voltage	V _{OL}	V _{CC} = 4.5V, I _{SINK} = 20mA			0.4	V
		V _{CC} = 2.7V, I _{SINK} = 10mA			0.4	
Initial Fast CLOCK Frequency Accuracy	f _{FCLOCK}	V _{CC} = 5V, T _A = +25°C (Note 2)	-2		+2	%
		V _{CC} = 2.7V to 5.5V, T _A = +25°C	-4		+4	

Silicon Oscillator with Low-Power Frequency Switching

MAX7377

ELECTRICAL CHARACTERISTICS (continued)

($V_{CC} = 2.7V$ to $5.5V$, $T_A = -40^{\circ}C$ to $+125^{\circ}C$, unless otherwise noted. Typical values are at $V_{CC} = 5V$ and $T_A = +25^{\circ}C$.) (Note 1)

PARAMETER	SYMBOL	CONDITIONS	MIN	TYP	MAX	UNITS	
Fast CLOCK Frequency Temperature Sensitivity		(Note 3)		±50	±325	ppm/°C	
Initial Slow CLOCK Frequency Accuracy	f_{SCLOCK}	$V_{CC} = 5V$, $T_A = +25^{\circ}C$ (Note 2)	32.440	32.768	33.096	kHz	
		$V_{CC} = 2.7V$ to $5.5V$, $T_A = +25^{\circ}C$	31.785		33.751		
Slow CLOCK Frequency Temperature Sensitivity		(Note 3)		±50	±325	ppm/°C	
CLOCK Output Duty Cycle			43	50	57	%	
CLOCK Output Jitter		Observation of 8MHz output for 20s using a 500MHz oscilloscope		160		psp-p	
CLOCK Output Rise Time	t_R	10% to 90%		5		ns	
CLOCK Output Fall Time	t_F	90% to 10%		5		ns	
Startup Delay		V_{CC} rising from 0 to 5V in 1μs		100		μs	
Output Undervoltage Lockout	UVLO	V_{CC} rising	$T_A = +25^{\circ}C$	2.15	2.2	2.25	V
			$T_A = -40^{\circ}C$ to $+125^{\circ}C$	2.05		2.35	
Output Undervoltage Lockout Hysteresis	V_{THYS}			45		mV	

Note 1: All parameters are tested at $T_A = +25^{\circ}C$. Specifications over temperature are guaranteed by design.

Note 2: The frequency is determined by part number selection. See Table 1.

Note 3: Guaranteed by design. Not production tested.

Silicon Oscillator with Low-Power Frequency Switching

Typical Operating Characteristics

(V_{CC} = 5V, T_A = +25°C, unless otherwise noted.)

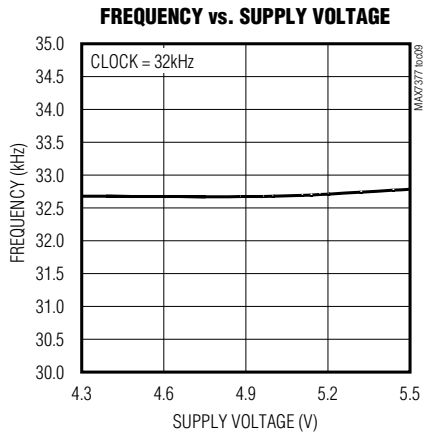
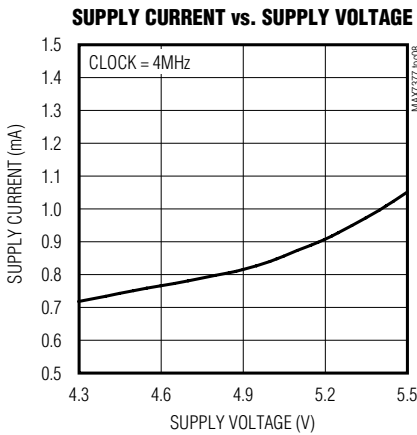
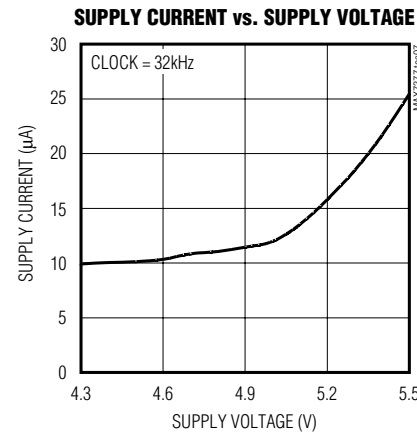
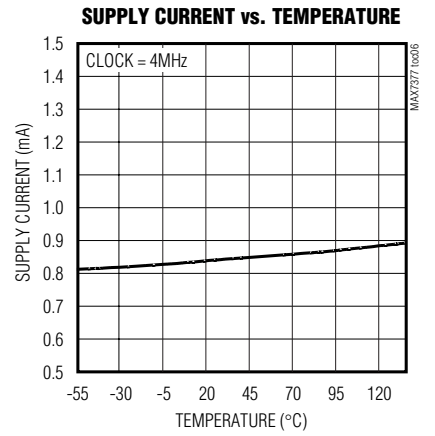
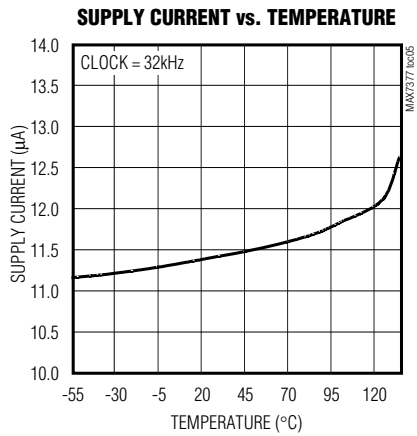
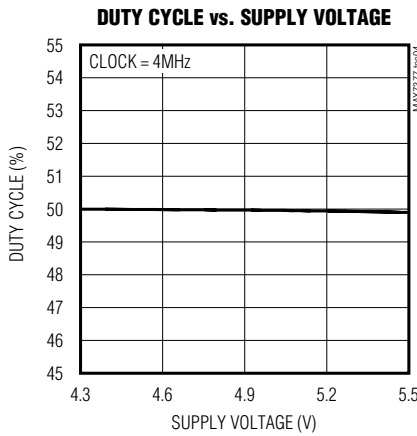
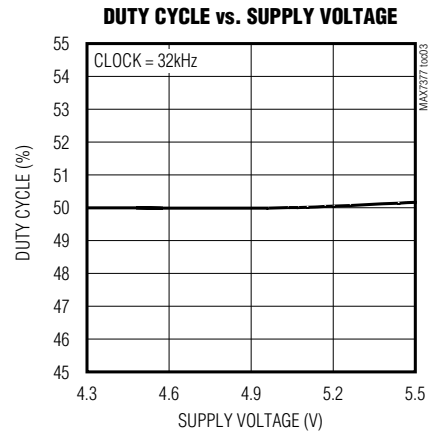
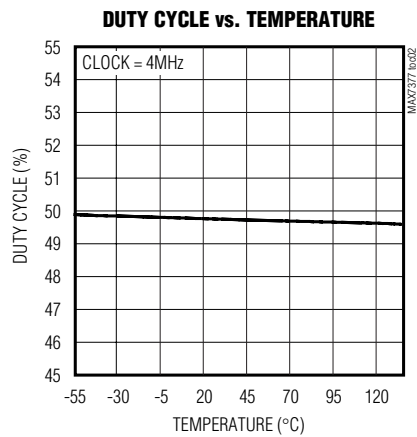
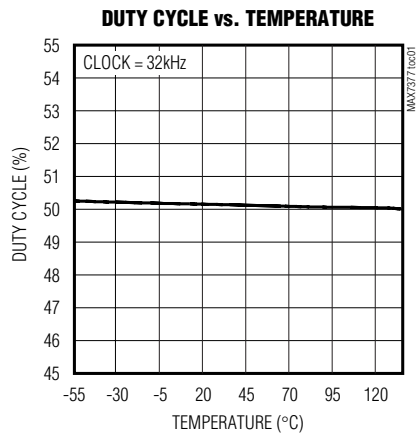

Silicon Oscillator with Low-Power Frequency Switching

MAX7377

Typical Operating Characteristics (continued)

($V_{CC} = 5V$, $T_A = +25^\circ C$, unless otherwise noted.)

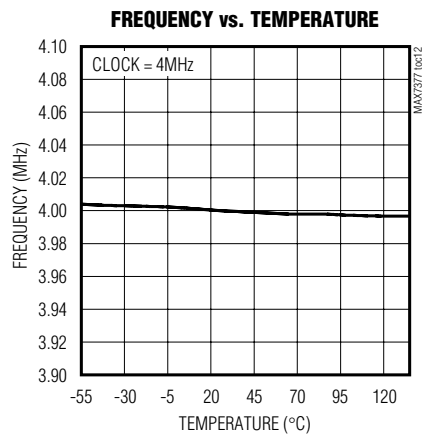
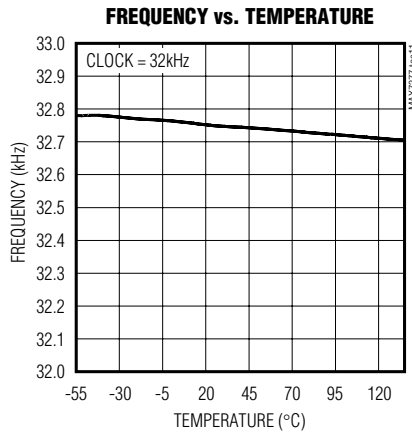
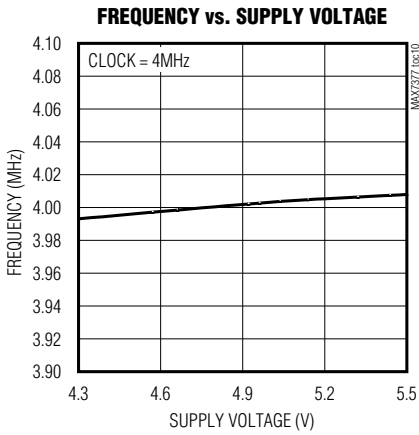

CLOCK OUTPUT WAVEFORM ($C_L = 10pF$)

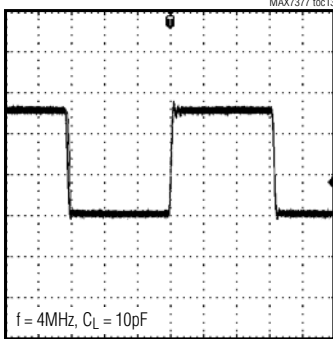

40ns/div

CLOCK OUTPUT WAVEFORM ($C_L = 50pF$)

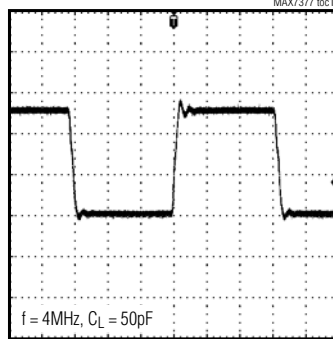

40ns/div

CLOCK OUTPUT WAVEFORM ($C_L = 100pF$)

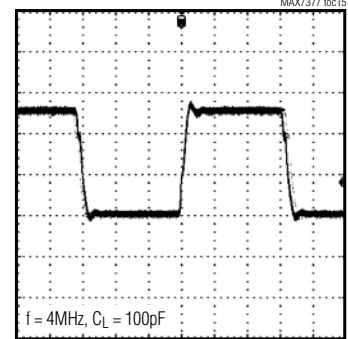

40ns/div

HIGH-SPEED TO LOW-SPEED TRANSITION

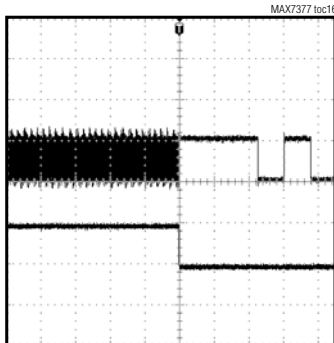

20 μs /div

HIGH-SPEED TO LOW-SPEED TRANSITION (EXPANDED SCALE)

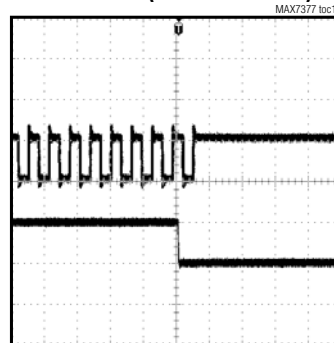

400ns/div

Silicon Oscillator with Low-Power Frequency Switching

Typical Operating Characteristics (continued)

($V_{CC} = 5V$, $T_A = +25^\circ C$, unless otherwise noted.)

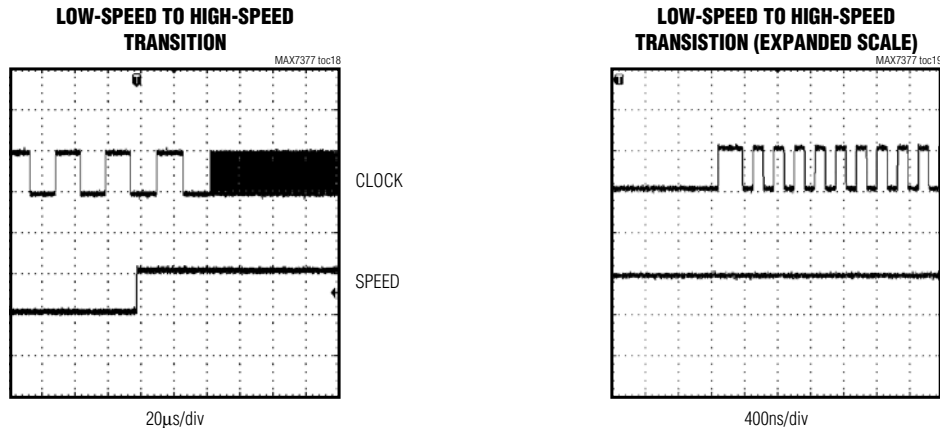

Pin Description

PIN	NAME	FUNCTION
1	CLOCK	Push-Pull Clock Output
2	GND	Ground
3	SPEED	Clock-Speed Select Input. Drive SPEED low to select the 32kHz fixed frequency. Drive SPEED high to select factory-trimmed frequency.
4	V_{CC}	Positive Supply Voltage. Bypass V_{CC} to GND with a 0.1µF capacitor.
5	E.C.	Must be Externally Connected to V_{CC}

Detailed Description

The MAX7377 is a dual-speed clock generator for microcontrollers (μC s) and UARTs in 3V, 3.3V, and 5V applications. (Figure 1). The MAX7377 is a replacement for two crystal oscillator modules, crystals, or ceramic resonators. The high-speed clock frequency is factory trimmed to specific values. A variety of popular standard frequencies are available. The low-speed clock frequency is fixed at 32.768kHz (Table 1). No external components are required for setting or adjusting the frequency.

Supply Voltage

The MAX7377 has been designed for use in systems with nominal supply voltages of 3V, 3.3V, or 5V and is specified for operation with supply voltages in the 2.7V to 5.5V range. See the *Absolute Maximum Ratings* section for limit values of power-supply and pin voltages.

Oscillator

The clock output is a push-pull configuration and is capable of driving a ground-connected 500 Ω or a positive-supply-connected 250 Ω load to within 400mV of either supply rail. The clock output remains stable over the full operating voltage range and does not generate short output cycles when switching between high- and low-speed modes. A typical startup characteristic is shown in the *Typical Operating Characteristics*.

Clock-Speed Select Input

The MAX7377 uses a logic input pin, SPEED, to set clock speed. Take this pin low to select slow clock speed (nominally 32.768kHz) or high to select full clock speed. The SPEED input can be strapped to V_{CC} or to GND to select fast or slow clock speed, or connected to a logic output (such as a processor port) used to change clock speed on the fly. If the SPEED input is connected to a processor port that powers up in the

Silicon Oscillator with Low-Power Frequency Switching

MAX7377

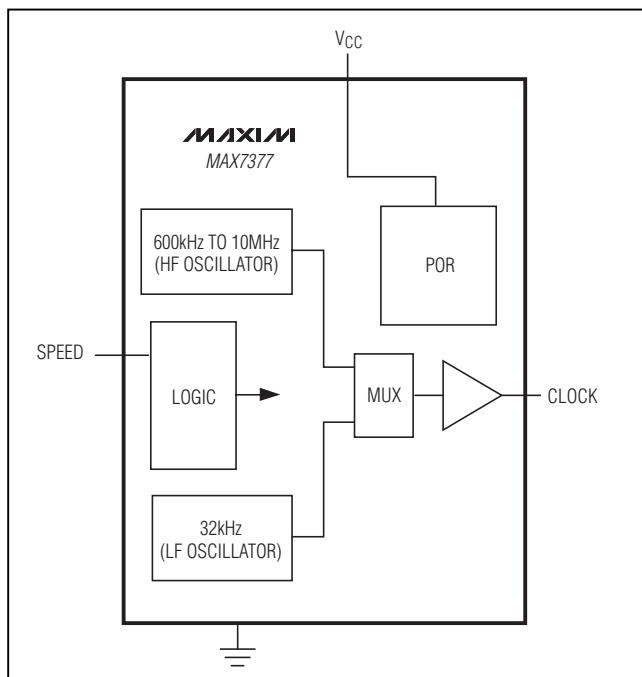

Figure 1. Functional Diagram

input condition, connect a pullup or pulldown resistor to the SPEED input to set the clock to the preferred speed on power-up. The leakage current through the resistor into the SPEED input is very low, so a resistor value as high as 500k Ω may be used.

Applications Information

Interfacing to a Microcontroller Clock Input

The MAX7377 clock output is a push-pull, CMOS, logic output that directly drives any microprocessor (μ P) or μ C clock input. There are no impedance-matching issues when using the MAX7377. The MAX7377 is not sensitive to its position on the board and does not need to be placed right next to the μ P. Refer to the microcontroller data sheet for clock-input compatibility with external clock signals. The MAX7377 requires no biasing components or load capacitance. When using the MAX7377 to retrofit a crystal oscillator, remove all biasing components from the oscillator input.

Output Jitter

The MAX7377's jitter performance is given in the *Electrical Characteristics* table as a peak-to-peak value obtained by observing the output of the MAX7377 for 20s with a 500MHz oscilloscope. Jitter values are approximately proportional to the period of the output frequency of the device. Thus, a 4MHz part has approximately twice the jitter value of an 8MHz part. The jitter performance of clock sources degrades in the presence of mechanical and electrical interference. The MAX7377 is relatively immune to vibration, shock, and EMI influences, and thus provides a considerably more robust clock source than crystal or ceramic resonator-based oscillator circuits.

Initial Power-Up and Operation

An internal power-up reset disables the oscillator until VCC has risen above 2.2V. The clock then starts up within 30 μ s (typ) at the frequency determined by the SPEED pin.

Extended Temperature Operation

The MAX7377 was tested to +135 $^{\circ}$ C during product characterization and shown to function normally at this temperature (see the *Typical Operating Characteristics*). However, production test and qualification is only performed from -40 $^{\circ}$ C to +125 $^{\circ}$ C at this time. Contact the factory if operation outside this range is required.

Power-Supply Considerations

The MAX7377 operates with a 2.7V and 5.5V power-supply voltage. Good power-supply decoupling is needed to maintain the power-supply rejection performance of the MAX7377. Bypass VCC to GND with a 0.1 μ F surface-mount ceramic capacitor. Mount the bypass capacitor as close to the device as possible. If possible, mount the MAX7377 close to the microcontroller's decoupling capacitor so that additional decoupling is not required. A larger value bypass capacitor is recommended if the MAX7377 is to operate with a large capacitive load. Use a bypass capacitor value of at least 1000 times that of the output load capacitance.

Silicon Oscillator with Low-Power Frequency Switching

Typical Application Circuit

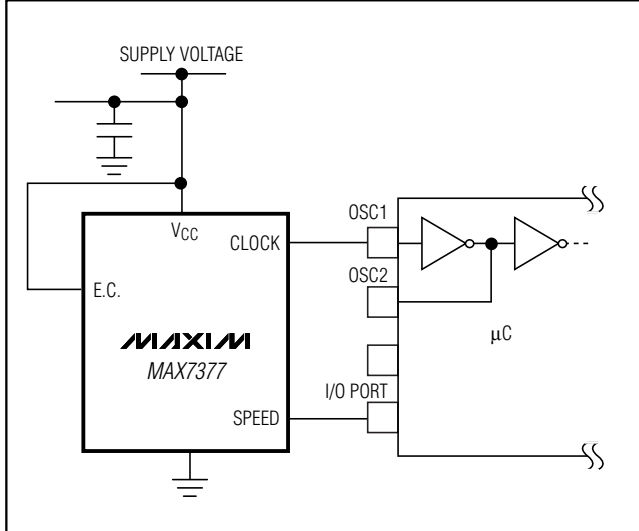

Table 1. Standard Frequencies

SUFFIX	STANDARD FREQUENCY (MHz)
MG	1
OK	1.8432
QT	3.39545
QW	3.6864
RD	4
RH	4.1943
TP	8

For all other reset threshold options, contact factory.

Table 2. Standard Part Numbers

PART	PIN-PACKAGE	FREQUENCY (Hz)	TOP MARK
MAX7377AXMG	5 SOT23	1M	AENE
MAX7377AXOK	5 SOT23	1.8432M	AEND
MAX7377AXQT	5 SOT23	3.39545M	AEMY
MAX7377AXQW	5 SOT23	3.6864M	AEMZ
MAX7377AXRD	5 SOT23	4M	AENA
MAX7377AXRH	5 SOT23	4.1943M	AENB
MAX7377AXTP	5 SOT23	8M	AENC

Chip Information

TRANSISTOR COUNT: 2027

PROCESS: BICMOS

Silicon Oscillator with Low-Power Frequency Switching

Package Information

(The package drawing(s) in this data sheet may not reflect the most current specifications. For the latest package outline information go to www.maxim-ic.com/packages.)

MAX7377

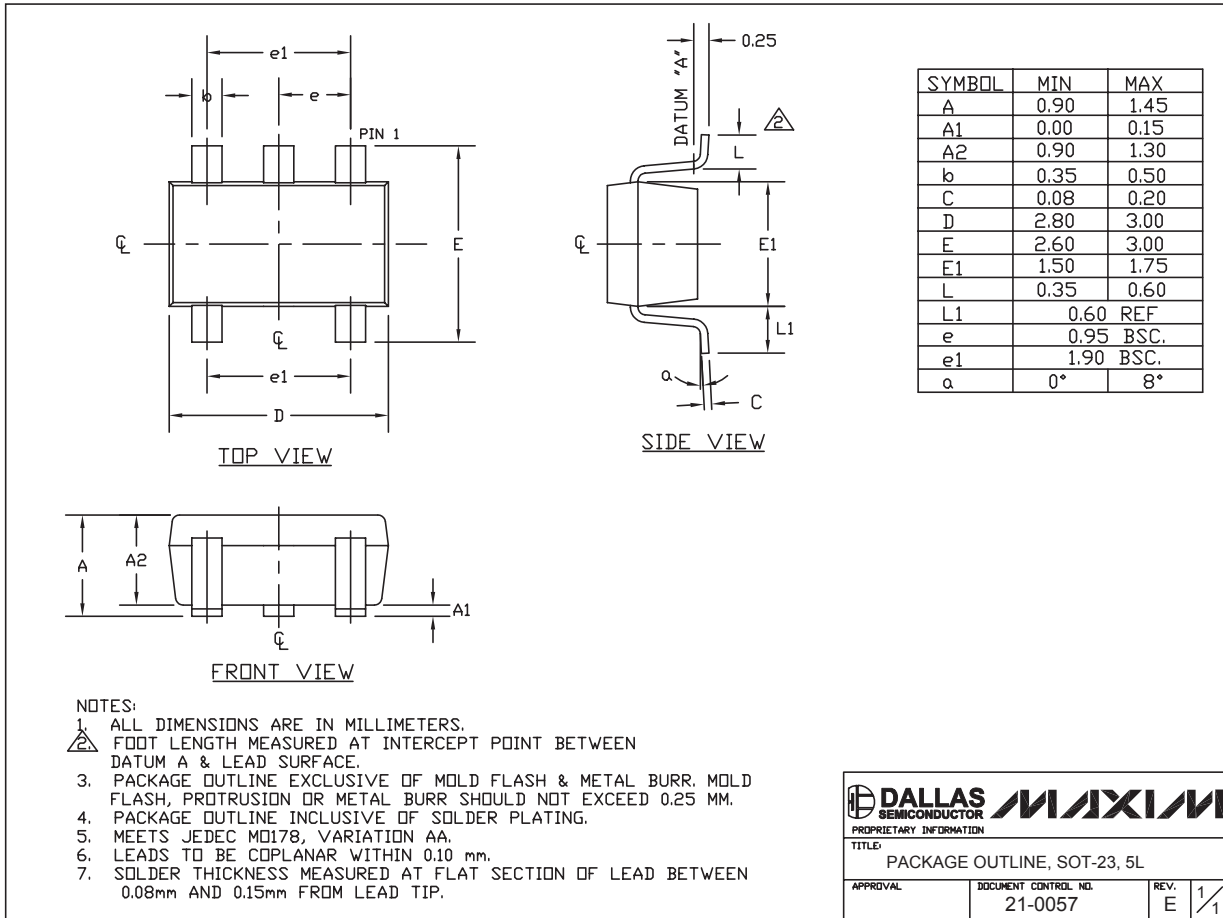

SOT-23 5L, EPS

PROPRIETARY INFORMATION	
TITLE: PACKAGE OUTLINE, SOT-23, 5L	
APPROVAL	DOCUMENT CONTROL NO. 21-0057
REV. E	1/1

Maxim cannot assume responsibility for use of any circuitry other than circuitry entirely embodied in a Maxim product. No circuit patent licenses are implied. Maxim reserves the right to change the circuitry and specifications without notice at any time.

Maxim Integrated Products, 120 San Gabriel Drive, Sunnyvale, CA 94086 408-737-7600 _____ 9