



SANYO Semiconductors

DATA SHEET

An ON Semiconductor Company

CMOS LSI

LC717A00AR — Capacitance-Digital-Converter LSI for Electrostatic Capacitive Touch Sensors

Overview

The LC717A00AR is a high-performance, low-cost capacitance-digital-converter LSI for electrostatic capacitive touch sensor, especially focused on usability. It has 8 channels capacitance-sensor input. The built-in logic circuit can detect the state (ON/OFF) of each input and output the result. This makes it ideal for various switch applications. The calibration function is automatically performed by the built-in logic circuit during power activation or whenever there are environmental changes. In addition, since initial settings of parameters, such as gain, are configured, LC717A00AR can operate as stand-alone when the recommended switch pattern is applied. Also, since LC717A00AR has a serial interface compatible with I²C and SPI bus, parameters can be adjusted using external devices whenever necessary. Moreover, outputs of the 8-input capacitance data can be detected and measured as 8-bit data.

Features

- Detection system: Differential capacitance detection (Mutual capacitance type)
- Input capacitance resolution: Can detect capacitance changes in the femto Farad order
- Measurement interval (8 differential inputs): 18ms (Typ) (at initial configuration),
3ms (Typ) (at minimum interval configuration)
- External components for measurement: Not required
- Current consumption: 320μA (Typ) (V_{DD} = 2.8V), 740μA (Typ) (V_{DD} = 5.5V)
- Supply voltage: 2.6V to 5.5V
- Detection operations: Switch
- Packages: VCT28
- Interface: I²C * compatible bus or SPI selectable.

* I²C Bus is a trademark of Philips Corporation.

- Any and all SANYO Semiconductor Co.,Ltd. products described or contained herein are, with regard to "standard application", intended for the use as general electronics equipment. The products mentioned herein shall not be intended for use for any "special application" (medical equipment whose purpose is to sustain life, aerospace instrument, nuclear control device, burning appliances, transportation machine, traffic signal system, safety equipment etc.) that shall require extremely high level of reliability and can directly threaten human lives in case of failure or malfunction of the product or may cause harm to human bodies, nor shall they grant any guarantee thereof. If you should intend to use our products for new introduction or other application different from current conditions on the usage of automotive device, communication device, office equipment, industrial equipment etc. , please consult with us about usage condition (temperature, operation time etc.) prior to the intended use. If there is no consultation or inquiry before the intended use, our customer shall be solely responsible for the use.
- Specifications of any and all SANYO Semiconductor Co.,Ltd. products described or contained herein stipulate the performance, characteristics, and functions of the described products in the independent state, and are not guarantees of the performance, characteristics, and functions of the described products as mounted in the customer's products or equipment. To verify symptoms and states that cannot be evaluated in an independent device, the customer should always evaluate and test devices mounted in the customer's products or equipment.

SANYO Semiconductor Co., Ltd.

<http://www.sanyosemi.com/en/network/>

LC717A00AR

Specifications

Absolute Maximum Ratings at Ta = +25°C

Parameter	Symbol	Ratings (V _{SS} = 0V)	Unit	Remarks
Supply voltage	V _{DD}	-0.3 to +6.5	V	
Input voltage	V _{IN}	-0.3 to V _{DD} +0.3	V	*1
Output voltage	V _{OUT}	-0.3 to V _{DD} +0.3	V	*2
Power dissipation	Pd max	160	mW	Ta = +105°C, Mounted on a substrate *3
Peak output current	I _{OP}	±8	mA	per terminal, 50% Duty ratio *2
Total output current	I _{OA}	±40	mA	Output total value of LSI, 25% Duty ratio
Storage temperature	Tstg	-55 to +125	°C	

*1) Apply to Cin0 to 7, Cref, nRST, SCL, SDA, SA, SCK, SI, nCS, GAIN

*2) Apply to Cdrv, Pout0 to 7, SDA, SO, ERROR, INTOUT

*3) 4-layer glass epoxy board (40×50×0.8t mm)

Recommended Operating Conditions

Parameter	Symbol	Conditions	min	typ	max	Unit	Remarks
Operating supply voltage	V _{DD}		2.6		5.5	V	
Supply ripple + noise	Vpp				±20	mV	*1
Operating temperature	Topr		-40	25	105	°C	

*1) Inserting a high-valued capacitor and a low-valued capacitor in parallel between V_{DD} and V_{SS} is recommended.

In this case, the small-valued capacitor should be at least 0.1μF, and is mounted near the LSI.

Electrical Characteristics at V_{SS} = 0V, V_{DD} = 2.6 to 5.5V, Ta = -40 to +105°C

* Unless otherwise specified, the Cdrv drive frequency is f_{CDRV} = 143kHz.

* Not tested at low temperature before shipment.

Parameter	Symbol	Conditions	min	typ	max	Unit	Remarks
Capacitance detection resolution	N				8	bit	
Output noise RMS	N _{RMS}	minimum gain setting			±1.0	LSB	*1 *3
Input offset capacitance adjustment range	Coff _{RANGE}			±8.0		pF	*1 *3
Input offset capacitance adjustment resolution	Coff _{RESO}			8		bit	
Cin offset drift	Cin _{DRIFT}	minimum gain setting			±8	LSB	*1
Cin detection sensitivity	Cin _{SENSE}	minimum gain setting	0.04		0.12	LSB/fF	*2
Cin pin leak current	I _{Cin}	Cin = Hi-Z		±25	±500	nA	
Cin allowable parasitic input capacitance	Cin _{SUB}	Cin against V _{SS}			30	pF	*1 *3
Cdrv drive frequency	f _{CDRV}		100	143	186	kHz	
Cdrv pin leak current	I _{CDRV}	Cdrv = Hi-Z		±25	±500	nA	
nRST minimum pulse width	t _{NRST}		1			μs	*1
Power-on reset time	t _{POR}				20	ms	*1
Power-on reset operation condition: Hold time	t _{POROP}		10			ms	*1
Power-on reset operation condition: Input voltage	V _{POROP}				0.1	V	*1
Power-on reset operation condition: Power supply rise rate	t _{VDD}	0V to V _{DD}	1			V/ms	*1
Pin input voltage	V _{IH}	High input	0.8V _{DD}			V	*1 *4
	V _{IL}	Low input			0.2V _{DD}		
Pin output voltage	V _{OH}	High output (I _{OH} = +3mA)	0.8V _{DD}			V	*5
	V _{OL}	Low output (I _{OL} = -3mA)			0.2V _{DD}		

Continued to the next page.

LC717A00AR

Continued from the previous page.

Parameter	Symbol	Conditions	min	typ	max	Unit	Remarks
SDA pin leak current	$V_{OL} I^2C$	SDA Low output ($I_{OL} = -3mA$)			0.4	V	
Pin leak current	I_{LEAK}				± 1	μA	*6
Current consumption	I_{DD}	When stand-alone configuration and non-touch $V_{DD} = 2.8V$		320	390	μA	*1 *3
		when stand-alone configuration and non-touch $V_{DD} = 5.5V$		740	900		
	I_{STBY}	During Sleep process			1	μA	*3

- *1) Design-guaranteed values (not tested before shipment)
- *2) Measurements conducted using the test mode in the LSI
- *3) $T_a = +25^{\circ}C$
- *4) Apply to nRST, SCL, SDA, SA, SCK, SI, nCS, GAIN
- *5) Apply to Cdrv, Pout0 to 7, SO, ERROR, INTOUT
- *6) Apply to nRST, SCL, SDA, SA, SCK, SI, nCS, GAIN

LC717A00AR

I²C Compatible Bus Timing Characteristics at V_{SS} = 0, V_{DD} = 2.6 to 5.5V, Ta = -40 to +105°C

*Not tested at low temperature before shipment

Parameter	Symbol	Pin Name	Conditions	min	typ	max	Unit	Remarks
SCL clock frequency	f _{SCL}	SCL				400	kHz	
START condition hold time	t _{HD;STA}	SCL SDA		0.6			μs	
SCL clock low period	t _{LOW}	SCL		1.3			μs	
SCL clock high period	t _{HIGH}	SCL		0.6			μs	
Repeated START condition setup time	t _{SU;STA}	SCL SDA		0.6			μs	*1
Data hold time	t _{HD;DAT}	SCL SDA		0		0.9	μs	
Data setup time	t _{SU;DAT}	SCL SDA		100			μs	*1
SDA, SCL rise/fall time	t _r / t _f	SCL SDA				300	μs	*1
STOP condition setup time	t _{SU;STO}	SCL SDA		0.6			μs	
STOP-to-START bus release time	t _{BUF}	SCL SDA		1.3			μs	*1

*1) Design-guaranteed values (not tested before shipment)

SPI Bus Timing Characteristics at V_{SS} = 0, V_{DD} = 2.6 to 5.5V, Ta = -40 to +105°C

*Not tested at low temperature before shipment

Parameter	Symbol	Pin Name	Conditions	min	typ	max	Unit	Remarks
SCK clock frequency	f _{SCK}	SCK				5	MHz	
SCK clock Low time	t _{LOW}	SCK		90			ns	*1
SCK clock High time	t _{HIGH}	SCK		90			ns	*1
Input signal rise/fall time	t _r / t _f	nCS SCK SI				300	ns	*1
nCS setup time	t _{SU;nCS}	nCS SCK		90			ns	*1
SCK clock setup time	t _{SU;SCK}	nCS SCK		90			ns	*1
Data setup time	t _{SU;SI}	SCK SI		20			ns	*1
Data hold time	t _{HD;SI}	SCK SI		30			ns	*1
nCS hold time	t _{HD;nCS}	nCS SCK		90			ns	*1
SCK clock hold time	t _{HD;SCK}	nCS SCK		90			ns	*1
nCS standby pulse width	t _{CPH}	nCS		90			ns	*1
Output high impedance time from nCS	t _{CHZ}	nCS SO				80	ns	*1
Output data determination time	t _v	SCK SO				80	ns	*1
Output data hold time	t _{HD;SO}	SCK SO		0			ns	*1
Output low impedance time from SCK clock	t _{CLZ}	SCK SO		0			ns	*1

*1) Design-guaranteed values (not tested before shipment)

LC717A00AR

Power-on Reset (POR)

When power is turned on, power-on reset is enabled inside the LSI and its state is released after a certain power-on reset time, t_{POR} . Power-on reset operation condition: Power supply rise rate t_{VDD} must be at least 1V/ms.

Since INTOUT pin changes from “High” to “Low” at the same time as the released of power-on reset state, it is possible to verify the t_{POR} externally.

During power-on reset state, C_{in} , C_{ref} and P_{out} are unknown.

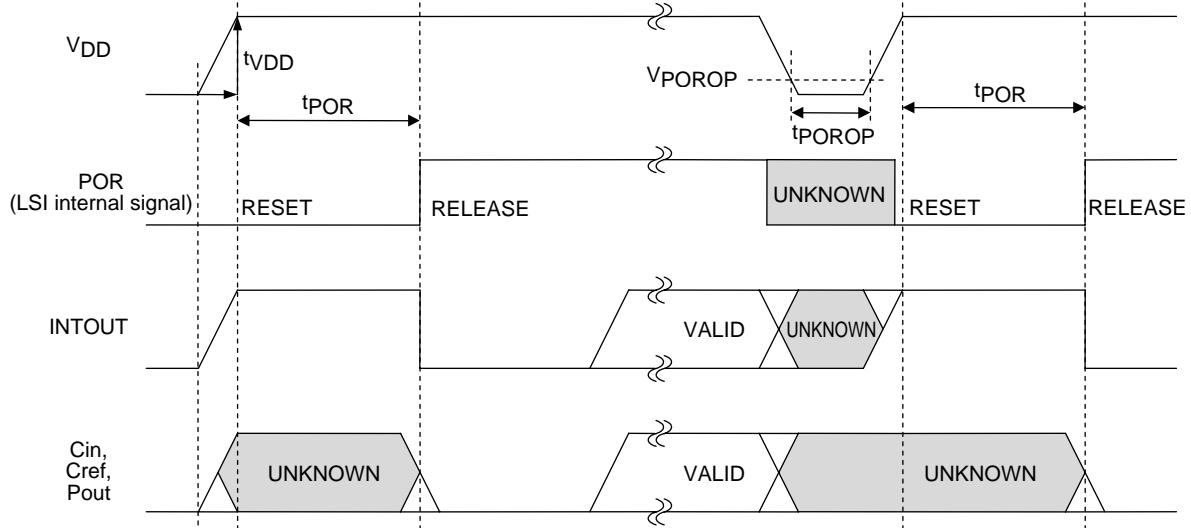

fig.1

I²C Compatible Bus Data Timing

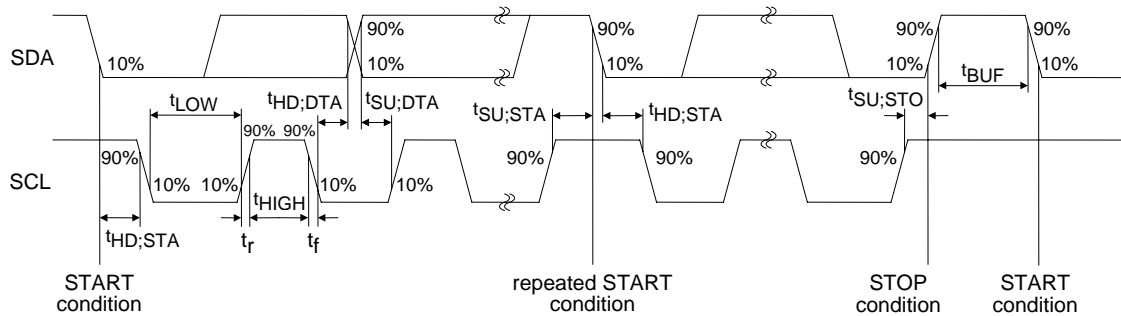

fig.2

I²C Compatible Bus Communication Formats

- Write format (data can be written into sequentially incremented addresses)



fig.3

- Read format (data can be read from sequentially incremented addresses)

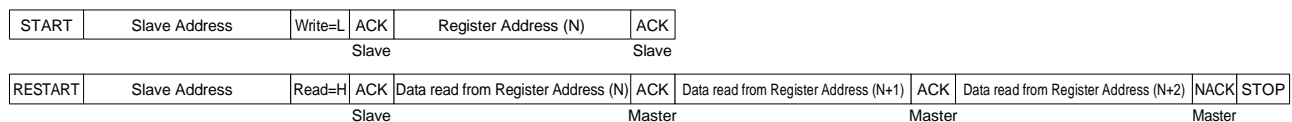

fig.4

LC717A00AR

I²C Compatible Bus Slave Address

Selection of two kinds of addresses is possible through the SA terminal.

SA pin input	7bit Slave Address	Binary Notation	8bit Slave Address
Low	0x16	00101100b (Write)	0x2C
		00101101b (Read)	0x2D
High	0x17	00101110b (Write)	0x2E
		00101111b (Read)	0x2F

SPI Data Timing (SPI Mode 0 / Mode 3)

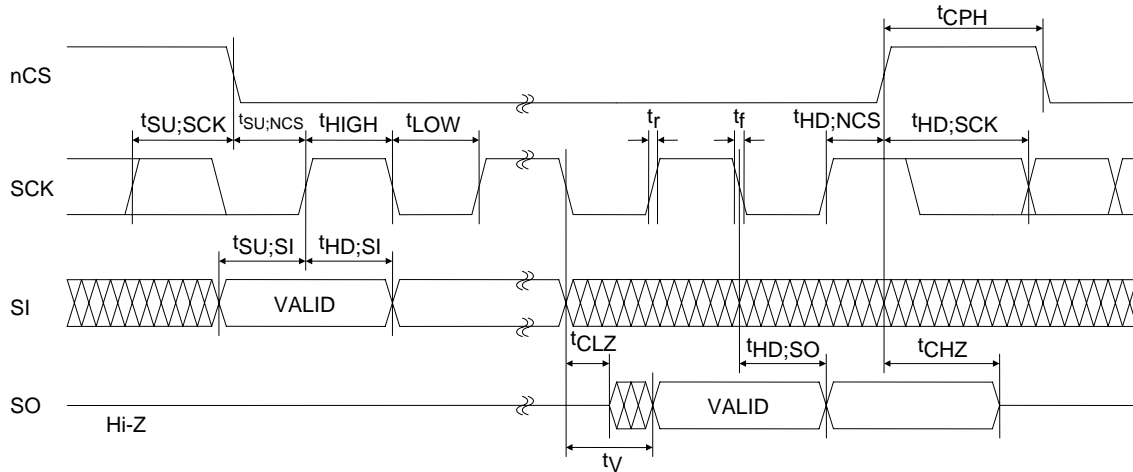

fig.5

SPI Communication Formats (Example of Mode 0)

- Write format (data can be written into sequentially incremented addresses while holding nCS = L)

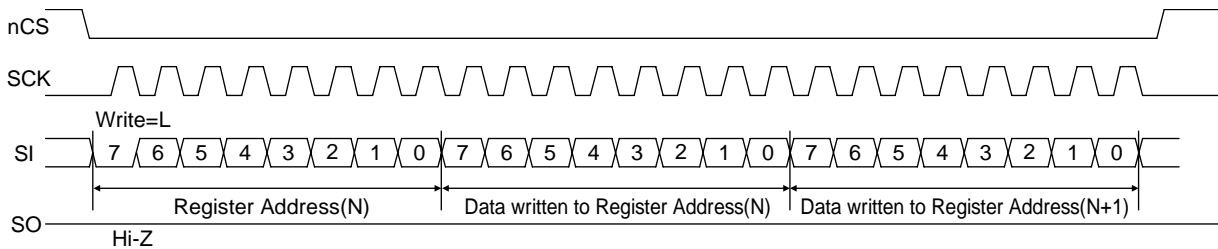

fig.6

- Read format (data can be read from sequentially incremented addresses while holding nCS = L)

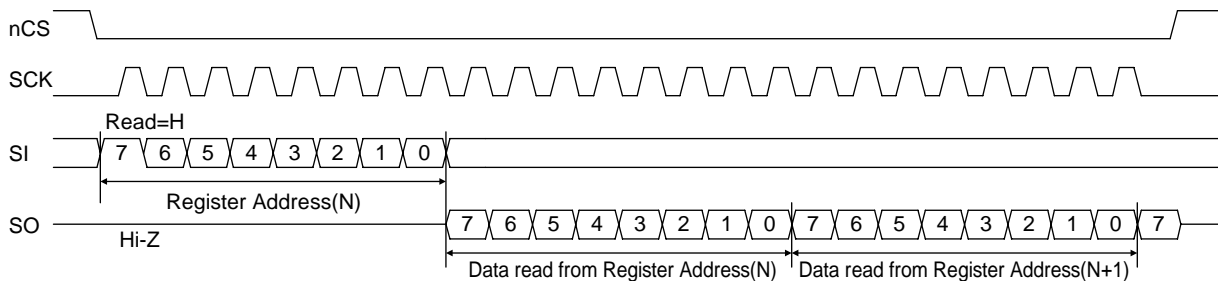

fig.7

LC717A00AR

Package Dimensions [LC717A00AR]

unit : mm (typ)

3357

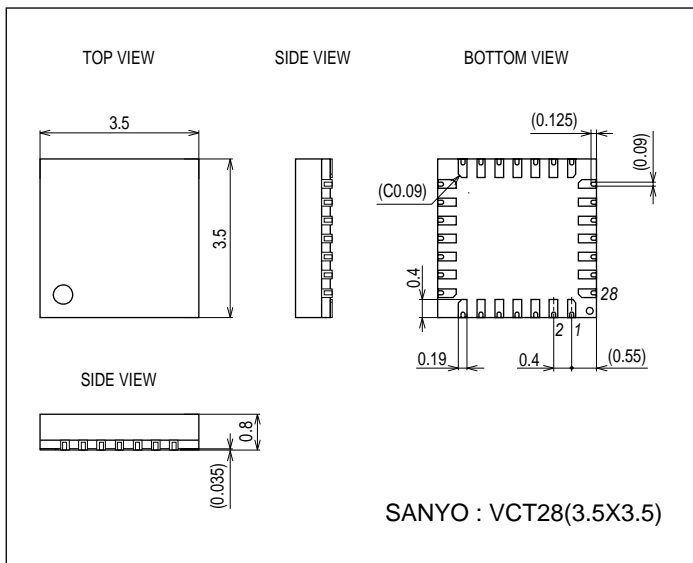

Pin Assignment

Pin No.	Pin Name	Pin No.	Pin Name
1	Cin0	15	Pout4
2	Cin1	16	Pout5
3	Cin2	17	Pout6
4	Cin3	18	Pout7
5	VDD	19	Cref
6	VSS	20	ERROR
7	Cin4	21	Cdrv
8	Cin5	22	INTOUT
9	Cin6	23	GAIN
10	Cin7	24	SCL/SCK
11	Pout0	25	SDA/SI
12	Pout1	26	SA/SO
13	Pout2	27	nCS
14	Pout3	28	nRST

LC717A00AR

Block Diagram

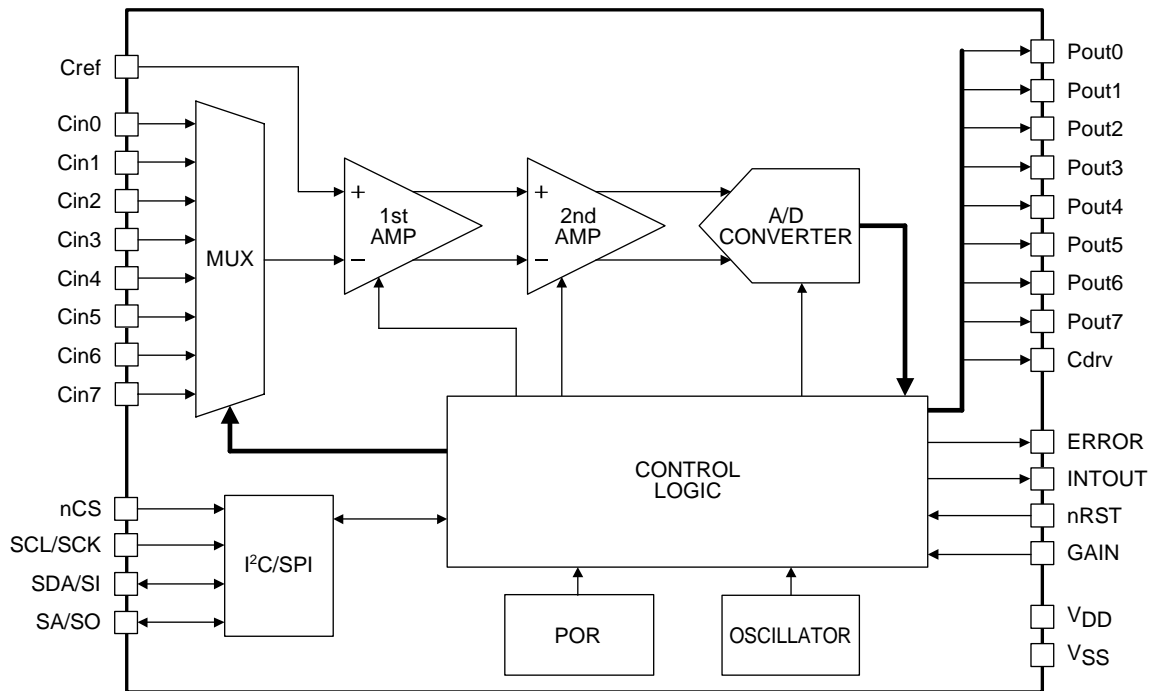

LC717A00AR is capacitance-digital-converter LSI capable of detecting changes in capacitance in the femto Farad order. It consists of an oscillation circuit that generates the system clock, a power-on reset circuit that resets the system when the power is turned on, a multiplexer that selects the input channels, a two-stage amplifier that detects the changes in the capacitance and outputs analog-amplitude values, a A/D converter that converts the analog-amplitude values into digital data, and a control logic that controls the entire chip. Also, it has an I²C compatible bus or SPI that enables serial communication with external devices as necessary.

LC717A00AR

Pin Functions

Pin Name	I/O	Pin Functions	Pin Type
Cin0	I/O	Capacitance sensor input	
Cin1	I/O	Capacitance sensor input	
Cin2	I/O	Capacitance sensor input	
Cin3	I/O	Capacitance sensor input	
Cin4	I/O	Capacitance sensor input	
Cin5	I/O	Capacitance sensor input	
Cin6	I/O	Capacitance sensor input	
Cin7	I/O	Capacitance sensor input	
Cref	I/O	Reference capacitance input	
Pout0	O	Cin0 judgment result output	
Pout1	O	Cin1 judgment result output	
Pout2	O	Cin2 judgment result output	
Pout3	O	Cin3 judgment result output	
Pout4	O	Cin4 judgment result output	
Pout5	O	Cin5 judgment result output	
Pout6	O	Cin6 judgment result output	
Pout7	O	Cin7 judgment result output	
ERROR	O	Error occurrence status output	
Cdrv	O	Output for capacitance sensors drive	
INTOUT	O	Interrupt output	
SCL/SCK	I	Clock input (I ² C) / Clock input (SPI)	
GAIN	I	Selection pin of the initial value of gain of the 2nd-amplifier	
nCS	I	Interface selection / Chip select inverting input (SPI)	
nRST	I	External reset signal inverting input	
SDA/SI	I/O	Data input and output (I ² C) / Data input (SPI)	
SA/SO	I/O	Slave address selection (I ² C) / Data output (SPI)	
V _{DD}		Power supply (2.6V to 5.5V) *1	
V _{SS}		Ground (Earth) *1 *2	

*1) Inserting a high-valued capacitor and a low-valued capacitor in parallel between V_{DD} and V_{SS} is recommended. In this case, the small-valued capacitor should be at least 0.1μF, and is mounted near the LSI.

*2) When V_{SS} terminal is not grounded in battery-powered mobile equipment, detection sensitivity may be degraded.

Details of Pin Functions

●Cin0 to Cin7

These are the capacitance-sensor-input pins. These pins are used by connecting them to the touch switch pattern. Cin and the Cdrv wire patterns should be close to each other. By doing so, Cdrv and Cin patterns are capacitively coupled. Therefore, LSI can detect capacitance change near each pattern as 8bit digital data.

However, if the shape of each pattern or the capacitively coupled value of Cdrv is not appropriate, it may not be able to detect the capacitance change correctly.

In this LSI, there is a two-stage amplifier that detects the changes in the capacitance and outputs analog-amplitude values. Cin0 to Cin7 are connected to the inverting input of the 1st amplifier in the LSI.

During measurement process, channels other than the one being measured are all in “Low” condition.

Leave the unused terminals open.

●Cref

It is the reference-capacitance-input pin. It is used by connecting to the wire pattern like Cin pins or is used by connecting any capacitance between this pin and Cdrv pin.

In this LSI, there is a two-stage amplifier that detects the changes in the capacitance and outputs analog-amplitude values. Cref is connected to the non-inverting input of the 1st amplifier in the LSI.

Due to the parasitic capacitance generated in the wire connections of Cin pins and their patterns, as well as the one generated between the wire patterns of Cin and Cdrv pins, Cref may not detect capacitance change of each Cin pin accurately. In this case, connect an appropriate capacitance between Cref and Cdrv to detect capacitance change accurately.

However, if the difference between the parasitic capacitance of each Cin pin is extremely large, it may not detect capacitance change in each Cin pin correctly.

●Pout0 to Pout7

These are the detection-result-output pins. The capacitance detection results of Cin0 to Cin7 are compared with the threshold of the LSI. The pin outputs a “High” or a “Low” depending on the result.

●ERROR

It is the error-occurrence-status-output pin.

It outputs “Low” during normal operation. If there is a calibration error or a system error, it outputs “High” to indicate that an error occurred.

●Cdrv

It is the output pin for capacitance sensors drive. It outputs the pulse voltage which is needed to detect capacitance at Cin0 to Cin7.

Cdrv and Cin wire patterns should be close to each other so that they are capacitively coupled.

●INTOUT

It is the interrupt-output pin. It outputs “High” when a measurement process is completed.

Connect to a main microcomputer if necessary, and use as interrupt signal.

Leave the terminal open if not in used.

●SCL/SCK

Clock input (I²C) / Clock input (SPI)

It is the clock input pin of the I²C compatible bus or the SPI depending on the mode of operation.

If interface is not to be used, fix the pin to “High”. However, even if interface is not to be used, providing a communication terminal on board is still recommended.

●GAIN

In this LSI, there is a two-stage amplifier that detects the changes in the capacitance and outputs analog-amplitude values. It is the selection pin of the initial value of gain of the 2nd amplifier.

Even if this LSI is used alone, gain setting can still be selected through this terminal. At initialization of the LSI, it is set to 7-times higher than the minimum setting when GAIN pin is “Low”, and is set to 14-times higher than the minimum setting when GAIN pin is “High”.

LC717A00AR

●nCS

Interface selection / Chip-select-inverting input (SPI)

Selection of I²C compatible bus mode or SPI mode is through this terminal. After initialization, the LSI is automatically in I²C compatible bus mode. To continually use I²C compatible bus mode, fix nCS pin to "High". To switch to SPI mode after LSI initialization, change the nCS input "High" → "Low". The nCS pin is used as the chip-select-inverting input pin of SPI, and SPI mode is kept until LSI is again initialized.

If interface is not to be used, fix the pin to "High".

●nRST

It is the external-reset-signal-inverting-input pin. When nRST pin is "Low", LSI is in the reset state.

Each pin (Cin0 to 7, Cref, Pout,0 to 7, ERROR) is "Hi-Z" during reset state.

●SDA/SI

Data input and output (I²C) / Data input (SPI)

It is the data input and output pin of the I²C compatible bus or the data input pin of the SPI depending on the mode of operation.

If interface is not to be used, fix the pin to "High". However, even if interface is not to be used, providing a communication terminal on board is still recommended.

●SA/SO

Slave address selection (I²C) / Data output (SPI)

It is the slave address selection pin of the I²C compatible bus or the data output pin of the SPI depending on the mode of operation.

If interface is not to be used, fix the pin to "High". However, even if interface is not to be used, providing a communication terminal on board is still recommended.

- SANYO Semiconductor Co.,Ltd. assumes no responsibility for equipment failures that result from using products at values that exceed, even momentarily, rated values (such as maximum ratings, operating condition ranges, or other parameters) listed in products specifications of any and all SANYO Semiconductor Co.,Ltd. products described or contained herein.
- Regarding monolithic semiconductors, if you should intend to use this IC continuously under high temperature, high current, high voltage, or drastic temperature change, even if it is used within the range of absolute maximum ratings or operating conditions, there is a possibility of decrease reliability. Please contact us for a confirmation.
- SANYO Semiconductor Co.,Ltd. strives to supply high-quality high-reliability products, however, any and all semiconductor products fail or malfunction with some probability. It is possible that these probabilistic failures or malfunction could give rise to accidents or events that could endanger human lives, trouble that could give rise to smoke or fire, or accidents that could cause damage to other property. When designing equipment, adopt safety measures so that these kinds of accidents or events cannot occur. Such measures include but are not limited to protective circuits and error prevention circuits for safe design, redundant design, and structural design.
- In the event that any or all SANYO Semiconductor Co.,Ltd. products described or contained herein are controlled under any of applicable local export control laws and regulations, such products may require the export license from the authorities concerned in accordance with the above law.
- No part of this publication may be reproduced or transmitted in any form or by any means, electronic or mechanical, including photocopying and recording, or any information storage or retrieval system, or otherwise, without the prior written consent of SANYO Semiconductor Co.,Ltd.
- Any and all information described or contained herein are subject to change without notice due to product/technology improvement, etc. When designing equipment, refer to the "Delivery Specification" for the SANYO Semiconductor Co.,Ltd. product that you intend to use.
- Upon using the technical information or products described herein, neither warranty nor license shall be granted with regard to intellectual property rights or any other rights of SANYO Semiconductor Co.,Ltd. or any third party. SANYO Semiconductor Co.,Ltd. shall not be liable for any claim or suits with regard to a third party's intellectual property rights which has resulted from the use of the technical information and products mentioned above.

This catalog provides information as of December, 2012. Specifications and information herein are subject to change without notice.