

**GaAs-IR-Lumineszenzdiode (Mini Sidelooker)**  
**GaAs Infrared Emitter (Mini Sidelooker)**  
**Lead (Pb) Free Product - RoHS Compliant**

**SFH 4110**



**Wesentliche Merkmale**

- Wellenlänge der Strahlung 950 nm
- Enger Abstrahlwinkel
- Hohe Strahlstärke
- Geringe Außenabmessungen
- Gehäusegleich mit Fototransistor SFH 3100 F
- Hoher Koppelfaktor in Lichtschranken in Verbindung mit SFH 3100 F
- Hohe Zuverlässigkeit

**Features**

- Peak wavelength of 950 nm
- Narrow half angle
- High radiant intensity
- Small outline dimensions
- Same package as phototransistor SFH 3100 F
- High coupling factor in light barriers with SFH 3100 F
- High reliability

**Anwendungen**

- Sender für Lichtschranken
- Bandende Erkennung (z.B. Videorecorder)
- Datenübertragung
- Positionsüberwachung
- Barcode-Leser
- „Messen/Steuern/Regeln“
- Münzzähler

**Applications**

- Emitter in photointerrupter
- Tape end detection (VCR e.g.)
- Data transmission
- Position sensing
- Barcode reader
- For control and drive circuits
- Coin counters

Typ Type	Bestellnummer Ordering Code	Strahlstärke <sup>1)</sup> ( $I_F = 20\text{mA}$ , $t_p = 20\text{ ms}$ ) Radiant intensity <sup>1)</sup> $I_e$ (mW/sr)
SFH 4110	Q62702P5072	$\geq 2.5$

<sup>1)</sup> gemessen bei einem Raumwinkel  $\Omega = 0.01\text{sr}$   
measured at a solid angle of  $\Omega = 0.01\text{ sr}$

**Grenzwerte ( $T_A = 25\text{ °C}$ )****Maximum Ratings**

Bezeichnung Parameter	Symbol Symbol	Wert Value	Einheit Unit
Betriebs- und Lagertemperatur Operating and storage temperature range	$T_{op}; T_{stg}$	- 40 ... + 85	°C
Sperrspannung Reverse voltage	$V_R$	5	V
Durchlaßstrom Forward current	$I_F$ (DC)	60	mA
Stoßstrom, $t_p = 10\ \mu\text{s}$ , $D = 0$ Surge current	$I_{FSM}$	1	A
Verlustleistung Power dissipation	$P_{tot}$	100	mW
Wärmewiderstand Sperrschicht - Umgebung Thermal resistance junction - ambient	$R_{thJA}$	280	K/W

**Kennwerte ( $T_A = 25\text{ °C}$ )****Characteristics**

Bezeichnung Parameter	Symbol Symbol	Wert Value	Einheit Unit
Wellenlänge der Strahlung Wavelength at peak emission	$\lambda_{peak}$	950	nm
Spektrale Bandbreite bei 50% von $I_{max}$ Spectral bandwidth at 50% of $I_{max}$	$\Delta\lambda$	55	nm
Abstrahlwinkel Half angle	$\varphi$	$\pm 9$	Grad deg.
Aktive Chipfläche Active chip area	$A$	0.0625	mm <sup>2</sup>
Abmessungen der aktiven Chipfläche Dimensions of the active chip area	$L \times B$ $L \times W$	$0.25 \times 0.25$	mm <sup>2</sup>
Schaltzeiten, $I_e$ von 10% auf 90% und von 90% auf 10%, bei $I_F = 20\text{ mA}$ , $R_L = 50\ \Omega$ Switching times, $I_e$ from 10% to 90% and from 90% to 10%, $I_F = 20\text{ mA}$ , $R_L = 50\ \Omega$	$t_r, t_f$	450/360	ns
Kapazität, Capacitance $V_R = 0\text{ V}$ , $f = 1\text{ MHz}$	$C_o$	16	pF

Kennwerte ( $T_A = 25\text{ °C}$ )

Characteristics (cont'd)

Bezeichnung Parameter	Symbol Symbol	Wert Value	Einheit Unit
Durchlaßspannung, Forward voltage $I_F = 20\text{ mA}$ , $t_p = 20\text{ ms}$	$V_F$	1.2 ( $\leq 1.4$ )	V
Sperrstrom, Reverse current $V_R = 3\text{ V}$	$I_R$	0.01 ( $\leq 1.0$ )	$\mu\text{A}$
Gesamtstrahlungsfluß, Total radiant flux $I_F = 20\text{ mA}$ , $t_p = 20\text{ ms}$	$\Phi_e$	2	mW
Temperaturkoeffizient von $I_e$ bzw. $\Phi_e$ , $I_F = 20\text{ mA}$ Temperature coefficient of $I_e$ or $\Phi_e$ , $I_F = 20\text{ mA}$	$TC_I$	- 0.55	%/K
Temperaturkoeffizient von $V_F$ , $I_F = 20\text{ mA}$ Temperature coefficient of $V_F$ , $I_F = 20\text{ mA}$	$TC_V$	- 1.8	mV/K
Temperaturkoeffizient von $\lambda$ , $I_F = 20\text{ mA}$ Temperature coefficient of $\lambda$ , $I_F = 20\text{ mA}$	$TC_\lambda$	+ 0.3	nm/K

**Strahlstärke  $I_e$  in Achsrichtung**gemessen bei einem Raumwinkel  $\Omega = 0.01\text{ sr}$ **Radiant Intensity  $I_e$  in Axial Direction**at a solid angle of  $\Omega = 0.01\text{ sr}$ 

Bezeichnung Parameter	Symbol	Werte Values	Einheit Unit
Strahlstärke <sup>1)</sup> Radiant intensity <sup>1)</sup> $I_F = 20\text{ mA}$ , $t_p = 20\text{ ms}$	$I_{e\text{ min}}$	2.5	mW/sr

1) Sonderselektion auf Anfrage.

1) Special bin selection on request.

**Relative Spectral Emission**

$I_{rel} = f(\lambda)$

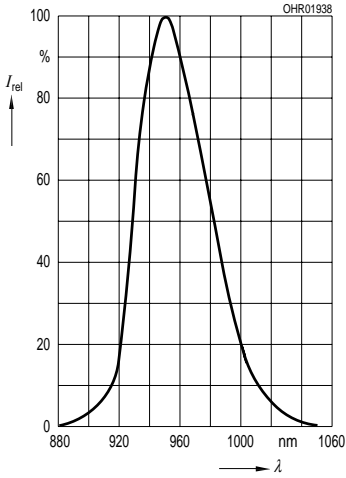

**Radiant Intensity**  $\frac{I_e}{I_e 100 \text{ mA}} = f(I_F)$

Single pulse,  $t_p = 20 \mu\text{s}$

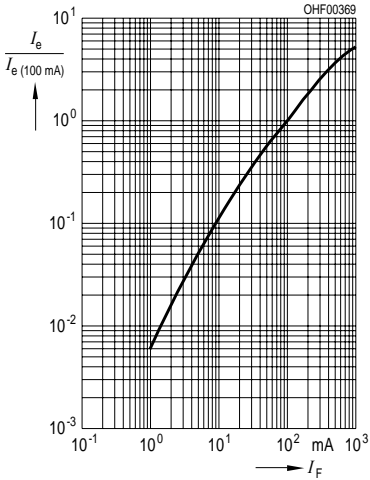

**Max. Permissible Forward Current**

$I_F = f(T_A)$

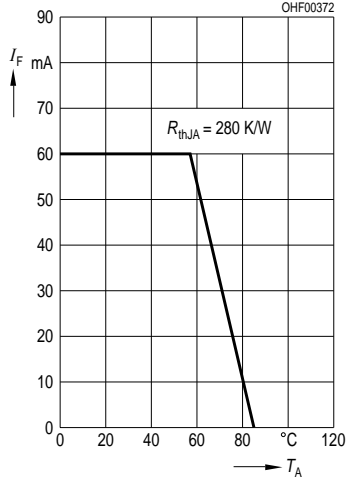

**Forward Current**

$I_F = f(V_F)$ , Single pulse,  $t_p = 20 \mu\text{s}$

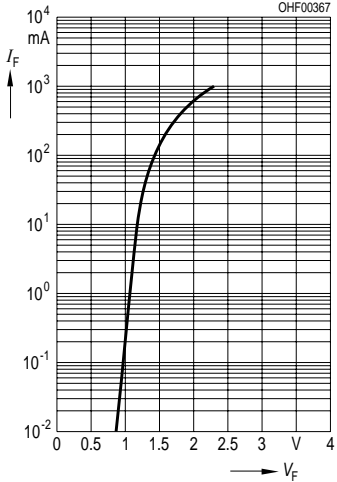

**Radiation Characteristics**

$I_{rel} = f(\phi)$

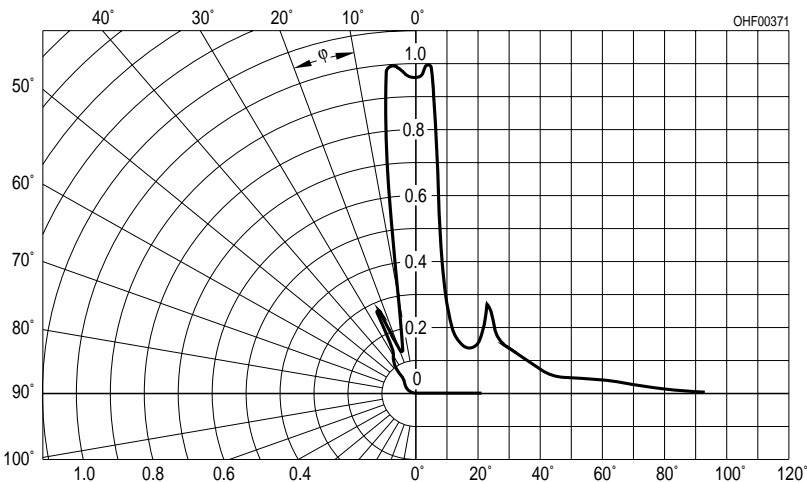

**Permissible Pulse Power**

Duty cycle  $D =$  parameter,  $T_A = 25 \text{ }^\circ\text{C}$

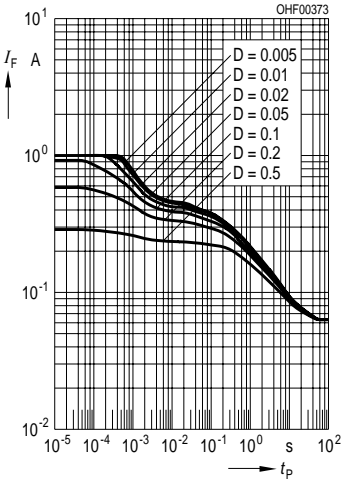

Maßzeichnung  
Package Outlines

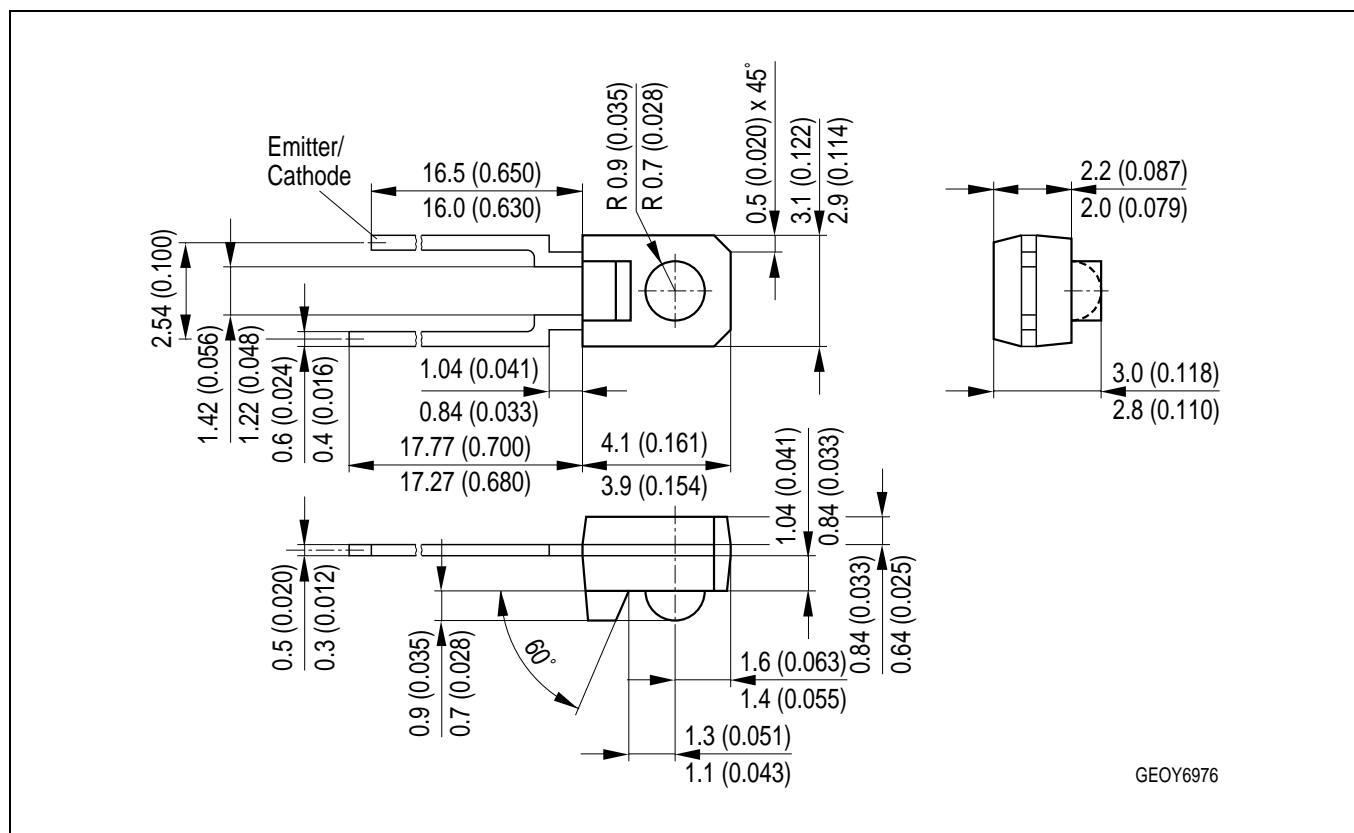

Maße in mm (inch) / Dimensions in mm (inch).

Empfohlenes Lötpad design  
Recommended Solder Pad

Wellenlöten (TTW)  
TTW Soldering

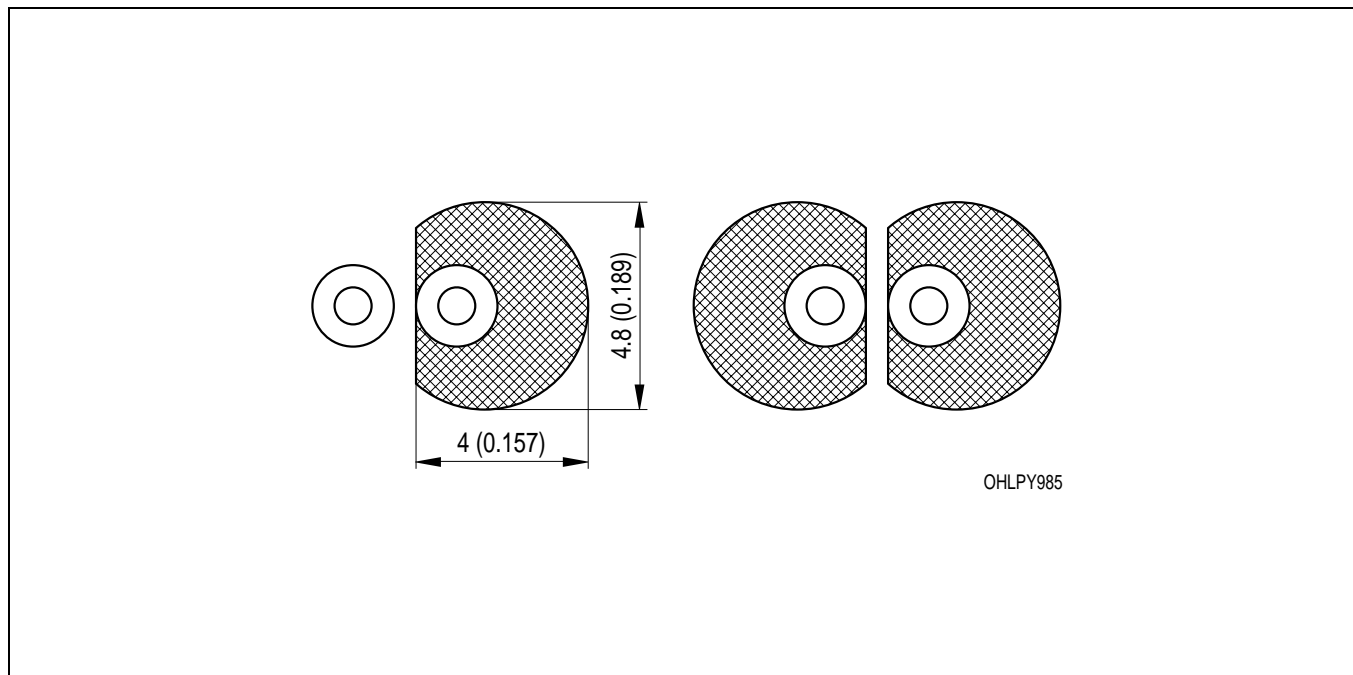

**Lötbedingungen**  
**Soldering Conditions**  
**Wellenlöten (TTW)**  
**TTW Soldering**

(nach CECC 00802)  
(acc. to CECC 00802)

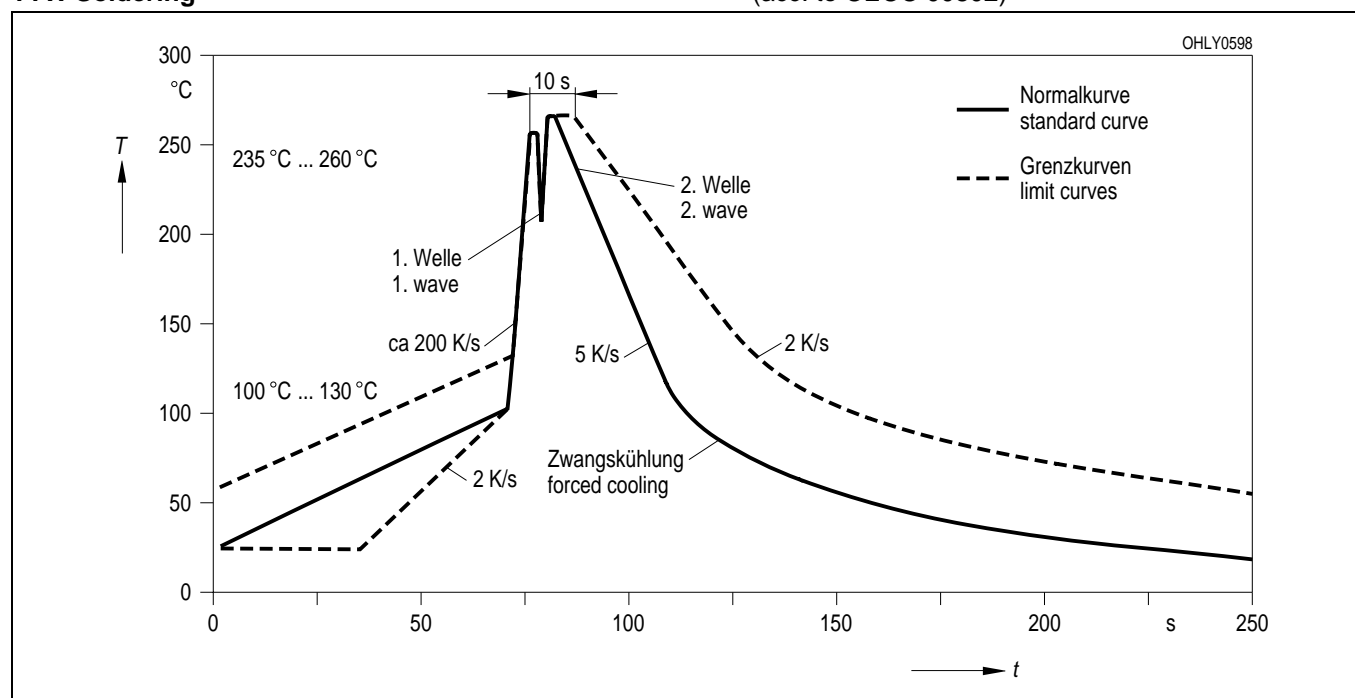

Published by  
**OSRAM Opto Semiconductors GmbH**  
Wernerwerkstrasse 2, D-93049 Regensburg  
[www.osram-os.com](http://www.osram-os.com)

© All Rights Reserved.

The information describes the type of component and shall not be considered as assured characteristics. Terms of delivery and rights to change design reserved. Due to technical requirements components may contain dangerous substances. For information on the types in question please contact our Sales Organization.

**Packing**

Please use the recycling operators known to you. We can also help you – get in touch with your nearest sales office. By agreement we will take packing material back, if it is sorted. You must bear the costs of transport. For packing material that is returned to us unsorted or which we are not obliged to accept, we shall have to invoice you for any costs incurred.

**Components used in life-support devices or systems must be expressly authorized for such purpose!** Critical components<sup>1</sup>, may only be used in life-support devices or systems<sup>2</sup> with the express written approval of OSRAM OS.

<sup>1</sup> A critical component is a component used in a life-support device or system whose failure can reasonably be expected to cause the failure of that life-support device or system, or to affect its safety or effectiveness of that device or system.

<sup>2</sup> Life support devices or systems are intended (a) to be implanted in the human body, or (b) to support and/or maintain and sustain human life. If they fail, it is reasonable to assume that the health of the user may be endangered.

EU RoHS and China RoHS compliant product



此产品符合欧盟 RoHS 指令的要求；

按照中国的相关法规和标准，不含有毒有害物质或元素。

# Mouser Electronics

## Related Product Links

[720-SFH4110 - Osram Opto Semiconductor SFH 4110](#)