

PRODUCT SPECIFICATION

DATE : 02/22/2011

| | | | |
|---|-----------------------------------|--------------|------|
| cosmo ELECTRONICS CORPORATION | SOLID STATE RELAY - MOSFET OUTPUT | NO.61M10025 | REV. |
| | KAQV216A | SHEET 1 OF 7 | 4 |

● **OUTSIDE DIMENSION :**

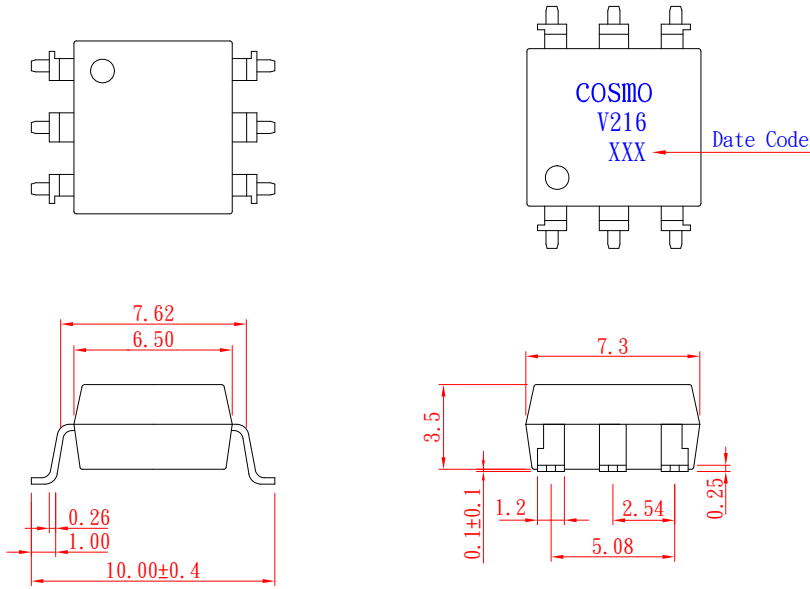

Unit : mm
Tolerance : ±0.2mm

● **Turn On / Turn Off time**

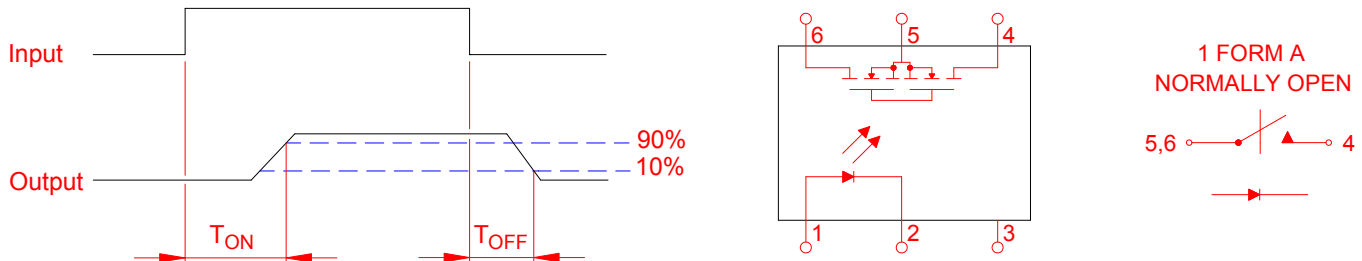

● **Absolute Maximum Ratings**

(Ta=25°C)

| Emitter (Input) | | Detector (Output) | |
|----------------------------------|----------------------|---------------------------------|-----------------|
| Reverse Voltage | 5.0V | Output Breakdown Voltage | ± 600V |
| Continuous Forward Current | 50mA | Continuous Load Current | ± 120mA |
| Peak Forward Current | 1A | Power Dissipation | 500mW |
| Power Dissipation | 100mW | | |
| Derate Linearly from 25°C | 1.3mW/°C | | |
| General Characteristics | | | |
| Isolation Test Voltage | 5000VACrms | Storage Temperature Range | -40°C to +125°C |
| Isolation Resistance | | Operating Temperature Range ... | -40°C to +85°C |
| Vio=500V , Ta=25°C | ≥ 10 ¹⁰ Ω | Junction Temperature | 100°C |
| Total Power Dissipation | 550mW | Soldering Temperature , | |
| Derate Linearly from 25°C | 2.5mW/°C | 2mm from case , 10 sec | 260°C |

PRODUCT SPECIFICATION

DATE : 02/22/2011

| | | | |
|---|--|-----------------------------|-----------|
| cosmo ELECTRONICS CORPORATION | SOLID STATE RELAY - MOSFET OUTPUT KAQV216A | NO.61M10025 SHEET 2 OF 7 | REV. 4 |
| | | | |

● Electro-optical Characteristics

(Ta=25°C)

| Parameter | Symbol | Conditions | Min. | Typ. | Max. | Unit. | |
|--------------------------|-------------------|--|--|------|------|---------------|----------|
| Emitter (Input) | | | | | | | |
| Forward Voltage | V_F | $I_F=10\text{mA}$ | | 1.2 | 1.5 | V | |
| Operation Input Current | $I_{F\text{ON}}$ | $V_L=\pm 20\text{V}$, $I_L=100\text{mA}$, $t=10\text{ms}$ | | | 5.0 | mA | |
| Recovery Input Current | $I_{F\text{OFF}}$ | $V_L=\pm 20\text{V}$, $I_L \leq 5\mu\text{A}$ | 0.2 | | | mA | |
| Detector (Output) | | | | | | | |
| Output Breakdown Voltage | V_B | $I_B=50\mu\text{A}$ | 600 | | | V | |
| Output Off-State Leakage | $I_{T\text{OFF}}$ | $V_T=600\text{V}$, $I_F=0\text{mA}$ | | 0.2 | 1 | μA | |
| I/O Capacitance | C_{ISO} | $I_F=0$, $f=1\text{MHz}$ | | 6 | | pF | |
| ON Resistance | Connection | A | $I_L=100\text{mA}$, $I_F=10\text{mA}$ | | 35 | 80 | Ω |
| | | B | | | 27 | 40 | |
| | | C | | | 15 | 20 | |
| Turn-On Time | T_{ON} | $I_F=10\text{mA}$, $V_L=\pm 20\text{V}$ $t=10\text{ms}$, $I_L=\pm 100\text{mA}$ | | 0.3 | 1.0 | ms | |
| Turn-Off Time | T_{OFF} | | | 0.5 | 1.5 | ms | |

● Schematic and Wiring Diagrams

| Schematic | Output configuration | Load | Connection | Wiring Diagrams |
|-----------|----------------------|-------|------------|-----------------|
| | 1a | AC/DC | A | |
| | | DC | B | |
| | | | | |
| DC | C | | | |

PRODUCT SPECIFICATION

DATE : 02/22/2011

cosmo
ELECTRONICS CORPORATION

SOLID STATE RELAY - MOSFET OUTPUT
KAQV216A

NO.61M10025
SHEET 3 OF 7

REV.
4

● Data Curve

Load current vs. ambient temperature
Allowable ambient Temperature :
-40°C to +85°C

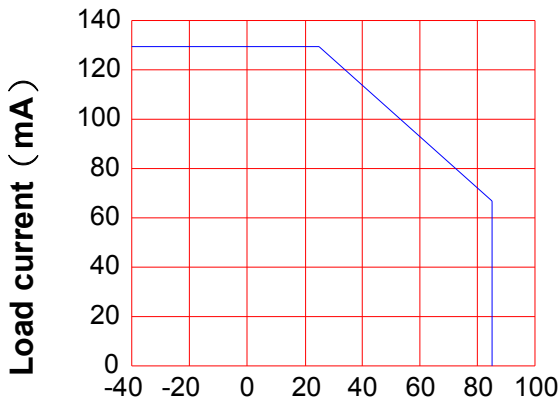

Ambient temperature Ta (°C)

On resistance vs. ambient temperature
across terminals 4 and 6 pin
LED current : 5mA
Continuous load current : 120mA (DC)

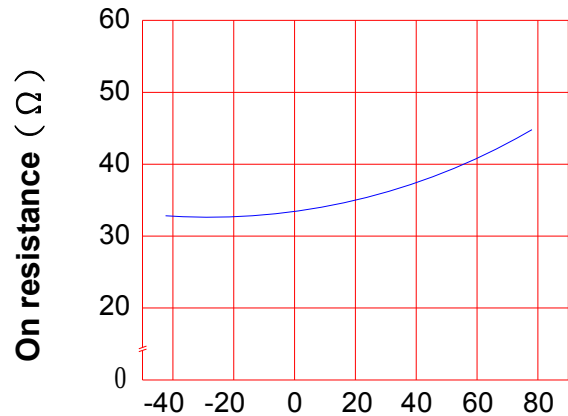

Ambient temperature Ta (°C)

Turn On Time vs. ambient temperature
Load voltage 600V (DC)
LED current : 5mA
Continuous load current : 120mA (DC)

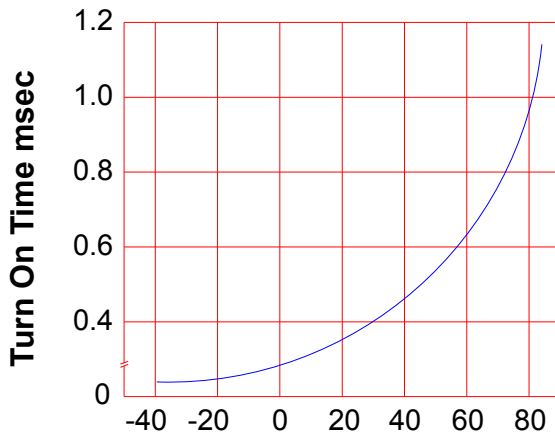

Ambient temperature Ta (°C)

Turn Off Time vs. ambient temperature
Load voltage 600V (DC)
LED current : 5mA
Continuous load current : 120mA (DC)

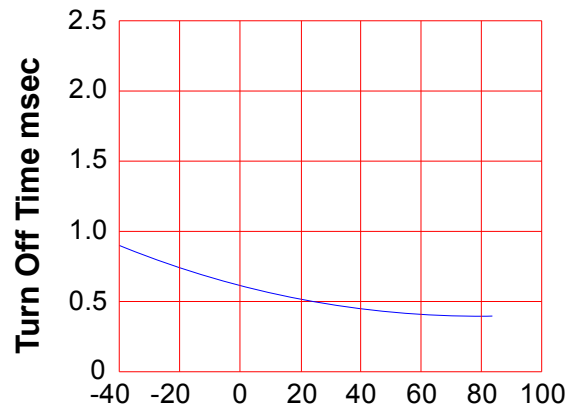

Ambient temperature Ta (°C)

PRODUCT SPECIFICATION

DATE : 02/22/2011

| | | | |
|---|-----------------------------------|--------------|------|
| cosmo ELECTRONICS CORPORATION | SOLID STATE RELAY - MOSFET OUTPUT | NO.61M10025 | REV. |
| | KAQV216A | SHEET 4 OF 7 | 4 |

LED operate current vs. ambient temperature
 Load Voltage : 600V (DC)
 Continuous load current : 120mA (DC)

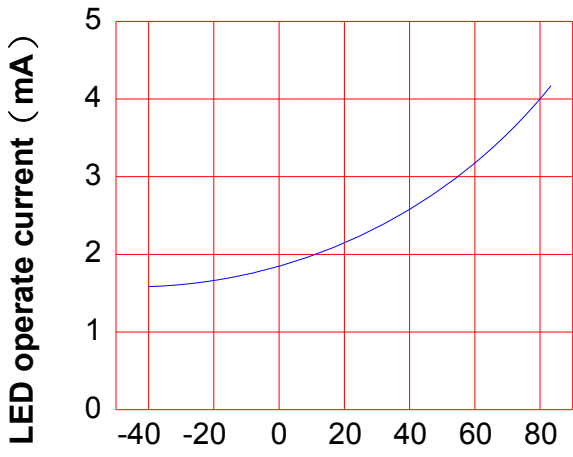

Ambient temperature Ta (°C)

LED Turn Off current vs. ambient temperature
 Load Voltage : 600V (DC)
 Continuous load current : 120mA (DC)

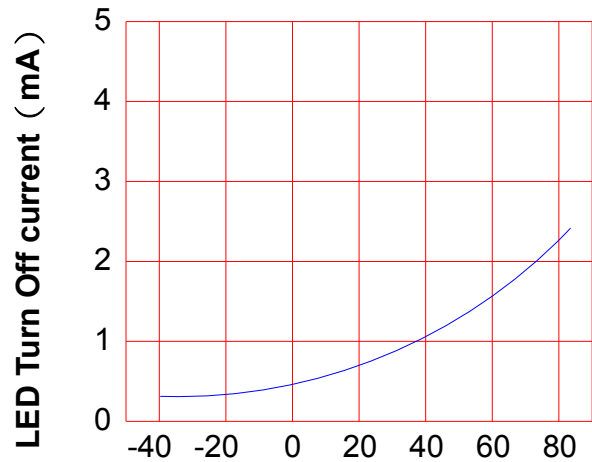

Ambient temperature Ta (°C)

LED dropout voltage vs. ambient temperature
 LED current : 5 to 50mA

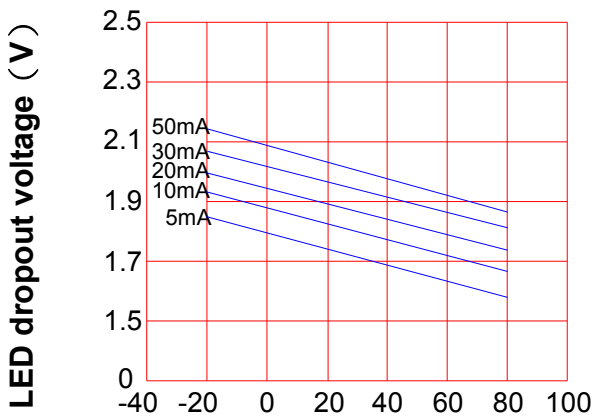

Ambient temperature Ta (°C)

Voltage vs. current characteristics of output at MOSFET portion
 Measured portion : across terminals 4 and 6 pin
 Ambient temperature : 25°C

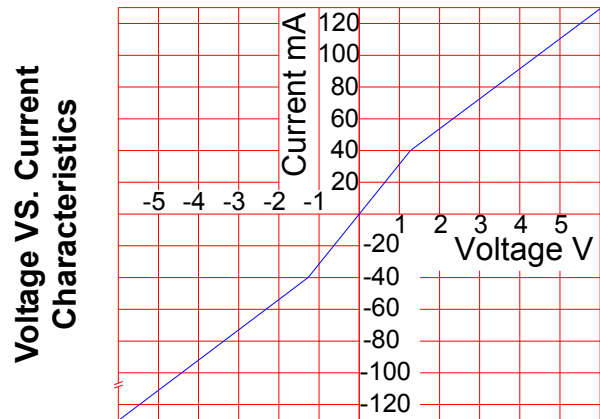

Ambient temperature : 25°C

PRODUCT SPECIFICATION

DATE : 02/22/2011

| | | | |
|---|--|-----------------------------|-----------|
| cosmo ELECTRONICS CORPORATION | SOLID STATE RELAY - MOSFET OUTPUT KAQV216A | NO.61M10025 SHEET 5 OF 7 | REV. 4 |
| | | | |

LED forward current vs. Turn On Time
 Across terminals 4 and 6 pin
 Load voltage : 600V (DC)
 Continuous load current : 120mA (DC)
 Ambient temperature : 25°C

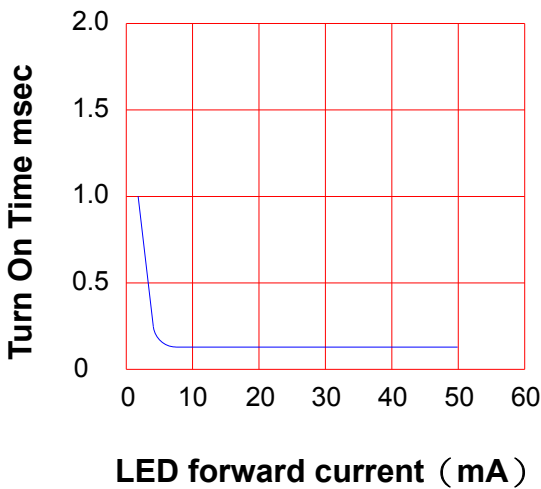

Off state leakage current
 Across terminals 4 and 6 pin
 Ambient temperature : 25°C

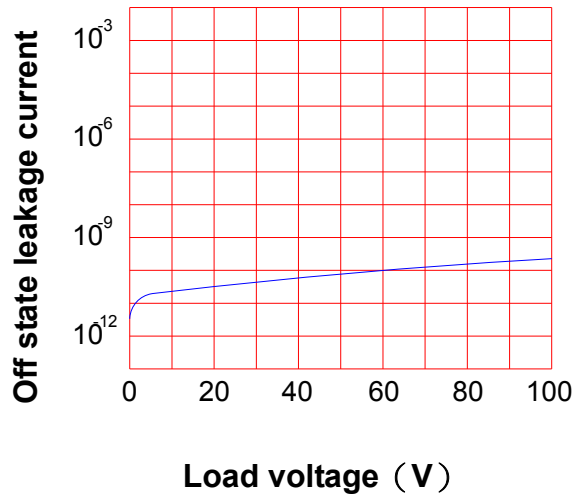

LED forward current vs. reverse(ON) time
 Across terminals 4 and 6 pin
 Load voltage : 600V (DC)
 Continuous load current : 120mA (DC)
 Ambient temperature : 25°C

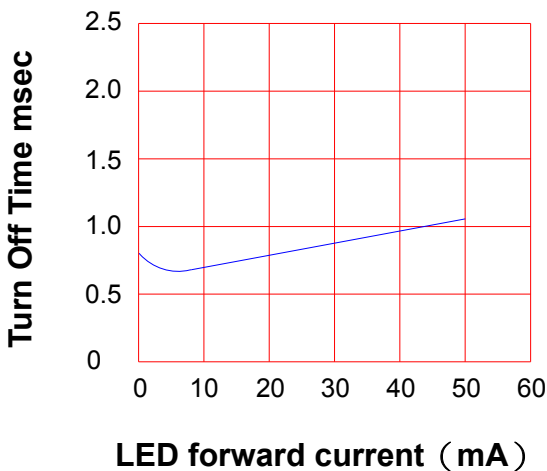

Applied voltage vs. output capacitance
 Across terminals 4 and 6 pin
 Frequency : 1MHz
 Ambient temperature : 25°C

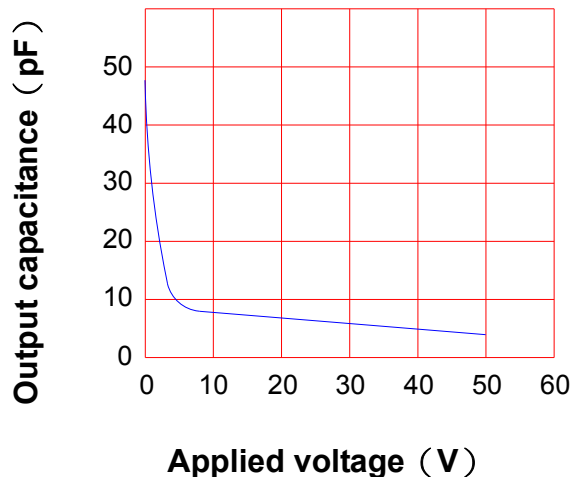

PRODUCT SPECIFICATION

DATE : 02/22/2011

| | | | |
|---|--|--------------|------|
| cosmo ELECTRONICS CORPORATION | SOLID STATE RELAY - MOSFET OUTPUT KAQV216A | NO.61M10025 | REV. |
| | | SHEET 6 OF 7 | 4 |

● USING METHODS

Examples of resistance value to control LED forward current (I_F)

SSR-MOSFET OUTPUT

($I_F=5\text{mA}$)

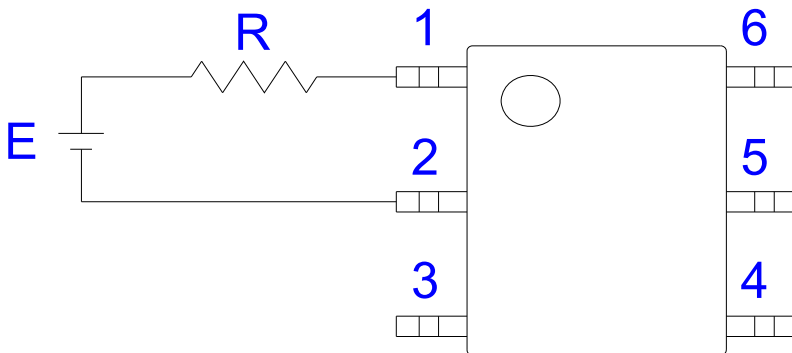

| E | R |
|------|-----------------------|
| 3.3V | Approx. 330 Ω |
| 5V | Approx. 640 Ω |
| 12V | Approx. 1.9K Ω |
| 15V | Approx. 2.5K Ω |
| 24V | Approx. 4.1K Ω |

- (1) LED forward current must be more than 5mA , at E min.
- (2) LED forward current must be less than 50mA , at E max.

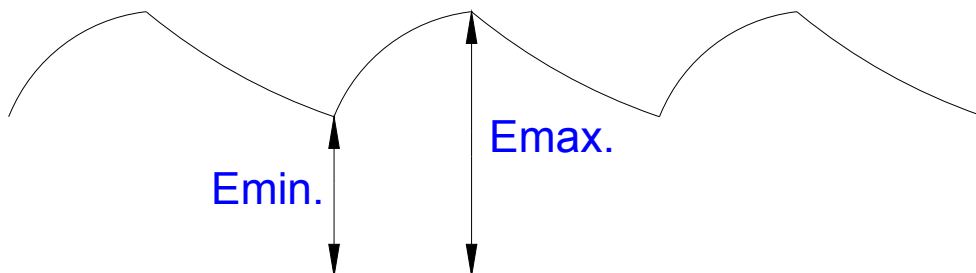

PRODUCT SPECIFICATION

DATE : 02/22/2011

cosmo
ELECTRONICS CORPORATION

SOLID STATE RELAY - MOSFET OUTPUT
KAQV216A

NO.61M10025
SHEET 7 OF 7

REV.
4

● USING METHODS

Regulate the spike voltage generated on the inductive load as follows :

