

# P1TX4C-SX4-01MM

## Product Specification Sheet

ORIGINATOR:	C. ENG	DATE:	7/8/2011
	P1TX4C-SX4x-01MM Product Specification	DOCUMENT NO. DOC002327	REV A
		SHEET 1 OF 7	

## 1.0 Features

- Multiple signals over one multimode fiber
- Integrated microcontroller for laser driver control
- ~ 0.5W power consumption
- Metal enclosure with SC optical interface

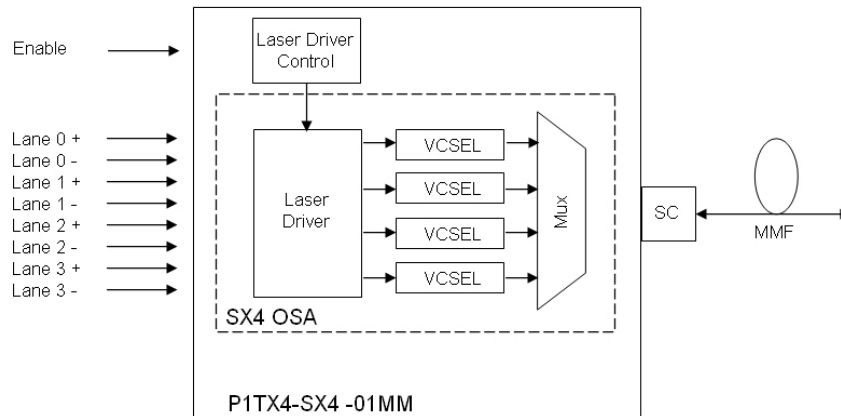

This device is **EXTREMELY SENSITIVE** to Electrostatic Discharge (ESD). At a minimum, all handling must be performed in accordance with an ANSI-compliant ESD Control Program (ANSI/ESD S20.20-2007) to mitigate possible ESD-induced damage. Reliability and life of the device will be adversely affected if these precautions are not met.



This device is a Class 3R Laser device (per IEC 60825-1:2007) and can cause damage to eye sight if used improperly. Refer to ANSI Z136 for proper handling and usage of Class 3R devices.



ORIGINATOR:	C. ENG	DATE:	7/8/2011
 <b>P1TX4C-SX4x-01MM Product Specification</b>	DOCUMENT NO. DOC002327	REV A	
	SHEET 2 OF 7		

## 2.0 Absolute Maximum Ratings

Parameter	Symbol	Min	Typ	Max	Units
Storage Temperature <sup>1</sup>	Tst				°C
3.3V Supply Voltage	VCC1				V
Operating Surface Temperature <sup>2</sup>	Ta				°C
Operating Humidity <sup>3</sup>	RH				%
Durability – SC Connector			200		cycles
Durability – Plug-down Connector			50		cycles

## 3.0 Optical Characteristics

Parameter (per Channel)	Symbol	Min	Typ	Max	Units
Average Optical Power, per Lane <sup>4</sup>	Pout		0.0		dBm
Optical Modulation Amplitude					dBm
Center Wavelength – Lane 0			778		nm
Center Wavelength – Lane 1			800		nm
Center Wavelength – Lane 2			825		nm
Center Wavelength – Lane 3			850		nm
Optical Rise/Fall Time <sup>5</sup> P1TX4C-SX4V-01 P1TX4C-SX4D-01			200 100		ps

<sup>1</sup> Stresses listed may be applied without causing damage. Functionality at or above the values listed is not implied. Exposure to these values for extended periods may affect reliability.

<sup>2</sup> See outline drawing for measurement point.

<sup>3</sup> Non condensing, 80% RH.

<sup>4</sup> I= 5mA, T=25C. Measured at the end of a 2m section of 62.5μ fiber.

<sup>5</sup> Rise and fall times measured from 20 - 80%

<b>ORIGINATOR:</b>	<b>C. ENG</b>	<b>DATE:</b>	<b>7/8/2011</b>
	<b>P1TX4C-SX4x-01MM Product Specification</b>	<b>DOCUMENT NO.</b> <b>DOC002327</b>	<b>REV</b> <b>A</b>
		<b>SHEET 3 OF 7</b>	

#### 4.0 Electrical Specifications

Parameter	Symbol	Min	Typ	Max	Units
Data Rate per Wavelength <sup>6</sup> P1TX4C-SX4V-01 P1TX4C-SX4D-01					Gb/s
Total Jitter (RMS) per lane <sup>7</sup>	T <sub>J1</sub>		10		ps
Input Differential Impedance			100		ohm
Input Differential Voltage					mVp-p
Single-ended Input Voltage					mVp-p
Common mode input voltage (AC-coupled input)			2.6		V
Operating Supply Voltage	V <sub>cc-Vee</sub>		3.30		V
Operating Supply Current	I <sub>cc</sub>		140		mA

#### 5.0 Fiber Transmission Distance<sup>8</sup>

Data Rate	Skew Limit	OM1	OM2	OM3	Units
1.65 Gbps	None	200	400	1000	m
	2.42ns	200	400	400	m
3.50 Gbps	None	100	200	500	m
	2.42ns	100	200	400	m
	1.78ns	100	200	294	m

<sup>6</sup> Requires DC-balanced data pattern and a max run length of 80 bits. Measured with input signals conforming to HDMI rev 1.3a, section 4.2.4, figure 4-18.

<sup>7</sup> Based on a jitter-free source. For optimal performance, clocks should be transmitted on Lane 0

<sup>8</sup> Max distance considers the worst-case conditions. Actual distance may be up to 4x specified distance.

## 6.0 Pin Numbers and Descriptions

The TX-SX4 plugs into a 30 pin connector. For information on the specifications of the connector, contact Hirose (DF12(4.0)-30DP-0.5V(86)).

Pin #	Signal	Name	Description
1	GND	Ground	Ground
2	NC	No connect	No Connect <sup>9</sup>
3	+ IN0	Ch 0 + Data Input	Positive differential input for 778nm channel
4	NC	No connect	No Connect <sup>9</sup>
5	- IN0	Ch 0 - Data Input	Negative differential input for 778nm channel
6	NC	No connect	No Connect <sup>9</sup>
7	+ IN1	Ch 1 + Data Input	Positive differential input for 800nm channel
8	NC	No connect	No Connect <sup>9</sup>
9	- IN1	Ch 1 - Data Input	Negative differential input for 800nm channel
10	NC	No connect	No Connect <sup>9</sup>
11	+ IN2	Ch 2 + Data Input	Positive differential input for 825nm channel
12	NC	No connect	No Connect <sup>9</sup>
13	- IN2	Ch 2 - Data Input	Negative differential input for 825nm channel
14	NC	No connect	No Connect <sup>9</sup>
15	+ IN3	Ch 3 + Data Input	Positive differential input for 850nm channel
16	NC	No connect	No Connect <sup>9</sup>
17	- IN3	Ch 3 - Data Input	Negative differential input for 850nm channel
18	EN	Enable	3.3V=normal operation, 0V turns off lasers
19	GND	Ground	Ground
20	NC	No connect	No Connect <sup>9</sup>
21	NC	No connect	No Connect <sup>9</sup>
22	NC	No connect	No Connect <sup>9</sup>
23	NC	No connect	No Connect <sup>9</sup>
24	NC	No connect	No Connect <sup>9</sup>
25	NC	No connect	No Connect <sup>9</sup>
26	NC	No connect	No Connect <sup>9</sup>
27	NC	No connect	No Connect <sup>9</sup>
28	VCC	Voltage Input	+3.3 volt input
29	GND	Ground	Ground
30	VCC	Voltage Input	+3.3 volt input

## 7.0 Laser Safety

The P1TX4C-SX4x-01 meets Class-3 requirements.

<sup>9</sup> NC = No Connect. Do not connect anything to this PIN.

<b>ORIGINATOR:</b>	<b>C. ENG</b>	<b>DATE:</b>	<b>7/8/2011</b>
	<b>P1TX4C-SX4x-01MM Product Specification</b>	<b>DOCUMENT NO.</b>	<b>REV</b>
		<b>DOC002327</b>	<b>A</b>
<b>SHEET 5 OF 7</b>			

## 8.0 Environmental Standards

Omron Network Products designs and manufactures its products to minimize the negative impact on our environment. As such, the P1TX4C-SX4-01MM conforms to a variety of environmental and safety standards

Standard	Compliant	Certificate Available
RoHS	Yes	Yes

ORIGINATOR:	C. ENG	DATE:	7/8/2011
	P1TX4C-SX4x-01MM Product Specification	DOCUMENT NO. DOC002327	REV A
SHEET 6 OF 7			

## 9.0 Dimensions

The SX4 TOSA is designed to work with a standard SC ferrule only. Insertion of any other type may result in damage.

Dimensions (mm) and orientation are for reference only.

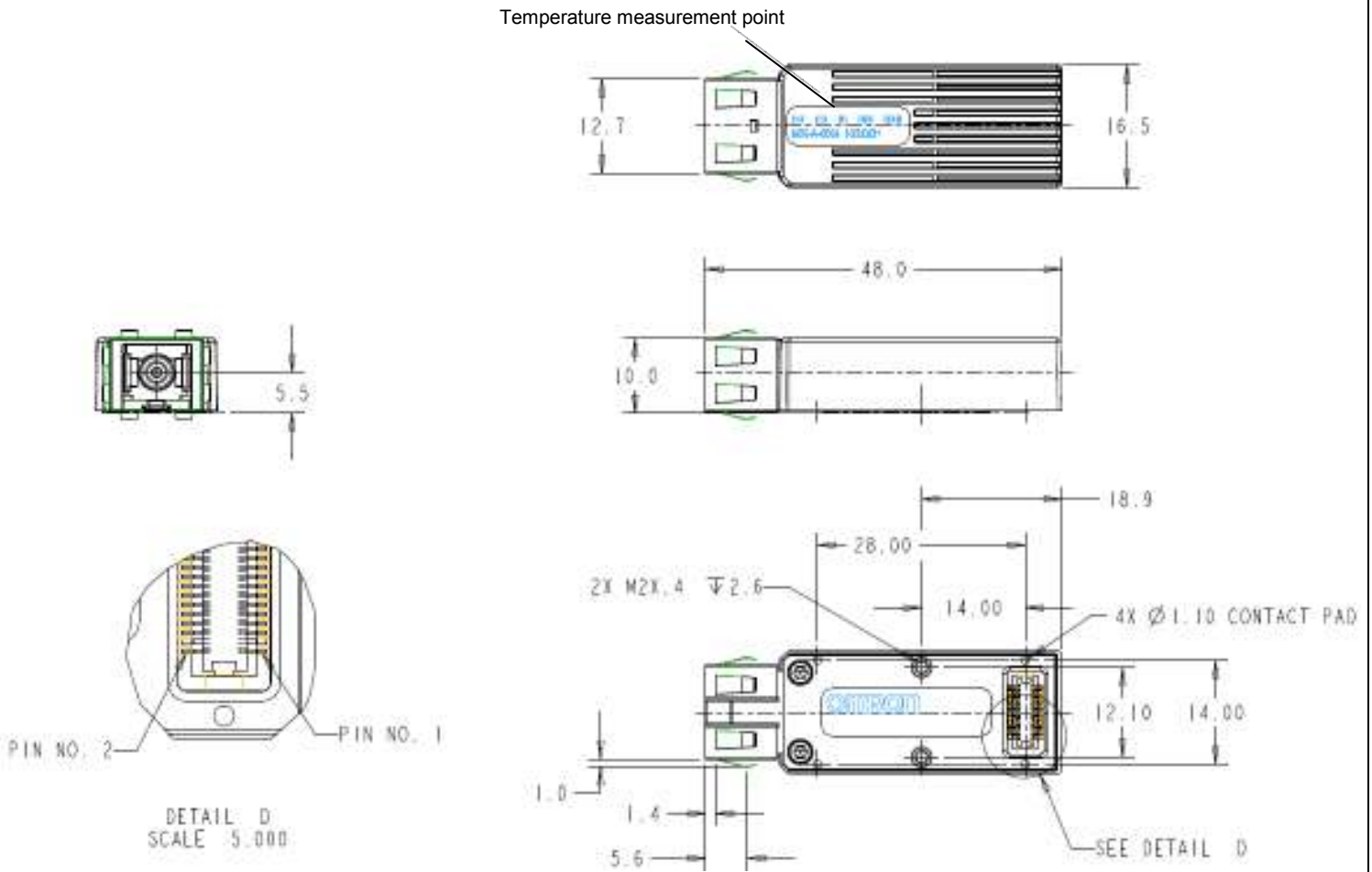

ORIGINATOR:

C. ENG

DATE:

7/8/2011