

# HFA08PB120

Ultrafast, Soft Recovery Diode

## Features

- Ultrafast Recovery
- Ultrasoft Recovery
- Very Low  $I_{RRM}$
- Very Low  $Q_{rr}$
- Guaranteed Avalanche
- Specified at Operating Conditions

## Benefits

- Reduced RFI and EMI
- Reduced Power Loss in Diode and Switching Transistor
- Higher Frequency Operation
- Reduced Snubbing
- Reduced Parts Count

## Description

International Rectifier's HFA08PB120 is a state of the art center tap ultra fast recovery diode. Employing the latest in epitaxial construction and advanced processing techniques it features a superb combination of characteristics which result in performance which is unsurpassed by any rectifier previously available. With basic ratings of 1200 volts and 8 amps continuous current, the HFA08PB120 is especially well suited for use as the companion diode for IGBTs and MOSFETs. In addition to ultra fast recovery time, the HEXFRED product line features extremely low values of peak recovery current ( $I_{RRM}$ ) and does not exhibit any tendency to "snap-off" during the  $t_b$  portion of recovery. The HEXFRED features combine to offer designers a rectifier with lower noise and significantly lower switching losses in both the diode and the switching transistor. These HEXFRED advantages can help to significantly reduce snubbing, component count and heatsink sizes. The HEXFRED HFA08PB120 is ideally suited for applications in power supplies and power conversion systems (such as inverters), motor drives, and many other similar applications where high speed, high efficiency is needed.

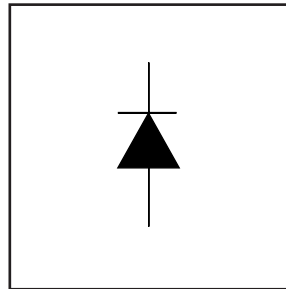

$V_R = 1200V$
$V_F(\text{typ.})^* = 2.4V$
$I_{F(AV)} = 8.0A$
$Q_{rr}(\text{typ.}) = 140nC$
$I_{RRM}(\text{typ.}) = 4.5A$
$t_{rr}(\text{typ.}) = 28ns$
$di_{(rec)}/dt(\text{typ.})^* = 85A/\mu s$

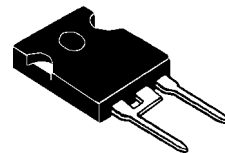

**TO-247AC  
(Modified)**

## Absolute Maximum Ratings

	Parameter	Max.	Units
$V_R$	Cathode-to-Anode Voltage	1200	V
$I_F @ T_C = 25^\circ C$	Continuous Forward Current		A
$I_F @ T_C = 100^\circ C$	Continuous Forward Current	8.0	
$I_{FSM}$	Single Pulse Forward Current	130	
$I_{FRM}$	Maximum Repetitive Forward Current	32	
$I_{AS} \textcircled{1}$	Maximum Single Pulse Avalanche Current	8.0	
$P_D @ T_C = 25^\circ C$	Maximum Power Dissipation	73.5	W
$P_D @ T_C = 100^\circ C$	Maximum Power Dissipation	29	
$T_J$	Operating Junction and	-55 to +150	$^\circ C$
$T_{STG}$	Storage Temperature Range		

\* 125°C

# HFA08PB120

International  
IOR Rectifier

## Electrical Characteristics @ T<sub>J</sub> = 25°C (unless otherwise specified)

	Parameter	Min.	Typ.	Max.	Units	Test Conditions
V <sub>BR</sub>	Cathode Anode Breakdown Voltage	1200	—	—	V	I <sub>R</sub> = 100μA
V <sub>FM</sub>	Max Forward Voltage	—	2.6	3.3	V	I <sub>F</sub> = 8.0A
		—	3.4	4.3		I <sub>F</sub> = 16A
		—	2.4	3.1		I <sub>F</sub> = 8.0A, T <sub>J</sub> = 125°C
I <sub>RM</sub>	Max Reverse Leakage Current	—	0.31	10	μA	V <sub>R</sub> = V <sub>R</sub> Rated
		—	135	1000		T <sub>J</sub> = 125°C, V <sub>R</sub> = 0.8 x V <sub>R</sub> Rated
C <sub>T</sub>	Junction Capacitance	—	11	20	pF	V <sub>R</sub> = 200V
L <sub>S</sub>	Series Inductance	—	8.0	—	nH	Measured lead to lead 5mm from package body

## Dynamic Recovery Characteristics @ T<sub>J</sub> = 25°C (unless otherwise specified)

	Parameter	Min.	Typ.	Max.	Units	Test Conditions
t <sub>rr</sub>	Reverse Recovery Time	—	28	—	ns	I <sub>F</sub> = 1.0A, di <sub>F</sub> /dt = 200A/μs, V <sub>R</sub> = 30V
t <sub>rr1</sub>	See Fig. 5, 10	—	63	95		T <sub>J</sub> = 25°C
t <sub>rr2</sub>		—	106	160		T <sub>J</sub> = 125°C
I <sub>RRM1</sub>	Peak Recovery Current	—	4.5	8.0	A	T <sub>J</sub> = 25°C
I <sub>RRM2</sub>	See Fig. 6	—	6.2	11		T <sub>J</sub> = 125°C
Q <sub>rr1</sub>	Reverse Recovery Charge	—	140	380	nC	T <sub>J</sub> = 25°C
Q <sub>rr2</sub>	See Fig. 7	—	335	880		T <sub>J</sub> = 125°C
di <sub>(rec)M</sub> /dt1	Peak Rate of Fall of Recovery Current	—	133	—	A/μs	T <sub>J</sub> = 25°C
di <sub>(rec)M</sub> /dt2	During t <sub>b</sub> See Fig. 8	—	85	—		T <sub>J</sub> = 125°C

## Thermal - Mechanical Characteristics

	Parameter	Min.	Typ.	Max.	Units
T <sub>lead</sub> ②	Lead Temperature	—	—	300	°C
R <sub>θJC</sub>	Thermal Resistance, Junction to Case	—	—	1.7	K/W
R <sub>θJA</sub> ③	Thermal Resistance, Junction to Ambient	—	—	40	
R <sub>θCS</sub> ④	Thermal Resistance, Case to Heat Sink	—	0.25	—	
Wt	Weight	—	6.0	—	g
		—	0.21	—	(oz)
	Mounting Torque	6.0	—	12	Kg-cm
		5.0	—	10	lbf·in

- ① L=100μH, duty cycle limited by max T<sub>J</sub>
- ② 0.063 in. from Case (1.6mm) for 10 sec
- ③ Typical Socket Mount
- ④ Mounting Surface, Flat, Smooth and Greased

Instantaneous Forward Current -  $I_F$  (A)

**Fig. 1** - Maximum Forward Voltage Drop vs. Instantaneous Forward Current

Reverse Current -  $I_R$  ( $\mu$ A)

**Fig. 2** - Typical Reverse Current vs. Reverse Voltage

Junction Capacitance -  $C_T$  (pF)

**Fig. 3** - Typical Junction Capacitance vs. Reverse Voltage

**Fig. 4** - Maximum Thermal Impedance  $Z_{thjc}$  Characteristics

$t_{rr}$  - (nC)

$I_{rr}$  - (A)

**Fig. 5** - Typical Reverse Recovery vs.  $di_f/dt$ ,  
(per Leg)

**Fig. 6** - Typical Recovery Current vs.  $di_f/dt$ ,  
(per Leg)

$Q_{rr}$  - (nC)

$di_{(rec)M}/dt$  - (A / $\mu$ s)

**Fig. 7** - Typical Stored Charge vs.  $di_f/dt$ ,  
(per Leg)

**Fig. 8** - Typical  $di_{(rec)M}/dt$  vs.  $di_f/dt$ ,  
(per Leg)

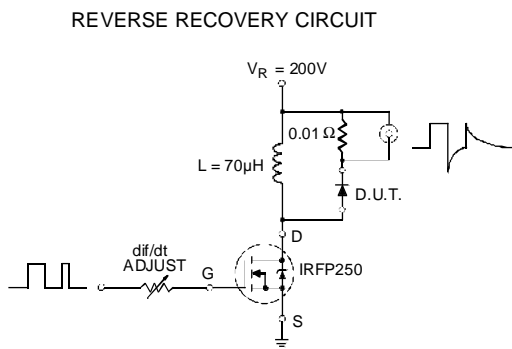

**Fig. 9 - Reverse Recovery Parameter Test Circuit**

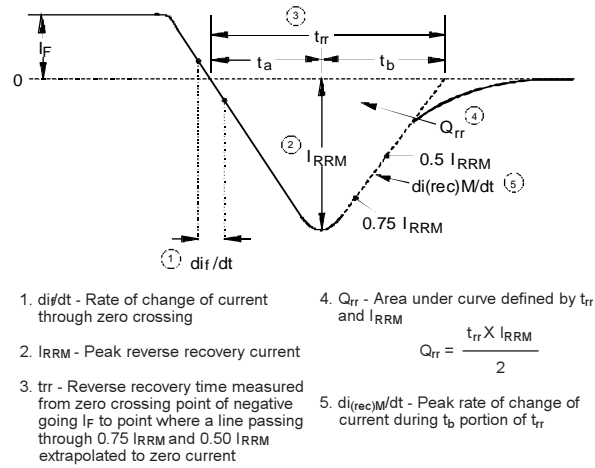

**Fig. 10 - Reverse Recovery Waveform and Definitions**

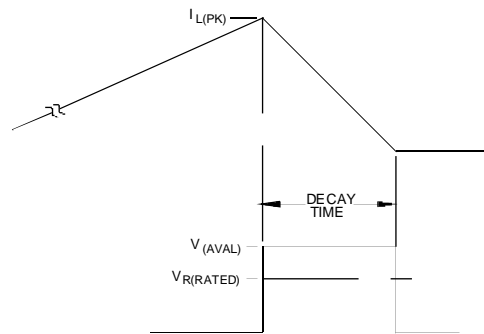
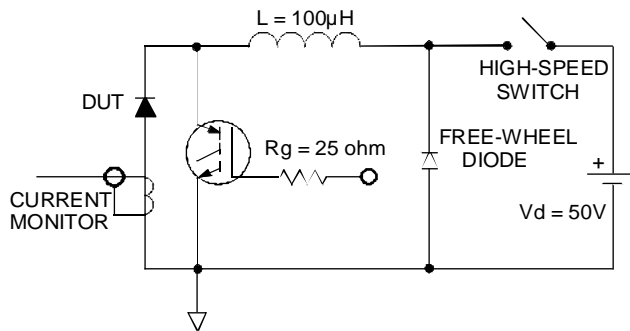

**Fig. 11 - Avalanche Test Circuit and Waveforms**

# HFA08PB120

International  
**IOR** Rectifier

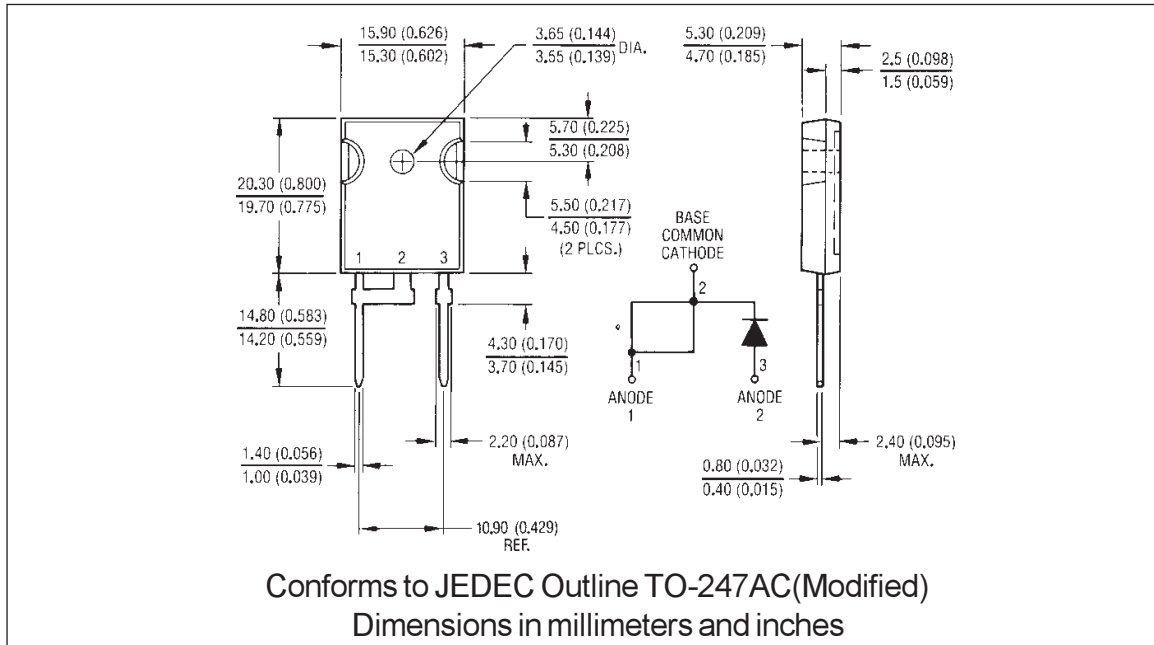

International  
**IOR** Rectifier

**WORLD HEADQUARTERS:** 233 Kansas St., El Segundo, California 90245, Tel: (310) 322 3331

**EUROPEAN HEADQUARTERS:** Hurst Green, Oxted, Surrey RH8 9BB, UK Tel: ++ 44 1883 732020

**IR CANADA:** 7321 Victoria Park Ave., Suite 201, Markham, Ontario L3R 2Z8, Tel: (905) 475 1897

**IR GERMANY:** Saalburgstrasse 157, 61350 Bad Homburg Tel: ++ 49 6172 96590

**IR ITALY:** Via Liguria 49, 10071 Borgaro, Torino Tel: ++ 39 11 451 0111

**IR FAR EAST:** K&H Bldg., 2F, 30-4 Nishi-Ikebukuro 3-Chome, Toshima-Ku, Tokyo Japan 171 Tel: 81 3 3983 0086

**IR SOUTHEAST ASIA:** 315 Outram Road, #10-02 Tan Boon Liat Building, Singapore 0316 Tel: 65 221 8371

<http://www.irf.com/> Data and specifications subject to change without notice. 5/97