

Photologic[®] Slotted Optical Switches Types OPB900W, OPB910W "Wide Gap" Series

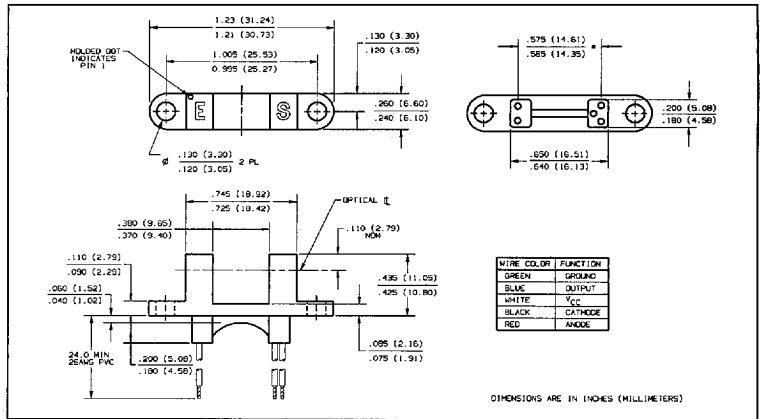
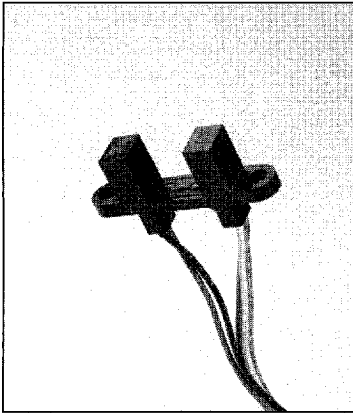

Features

- 0.375" (9.53 mm) wide gap
- Choice of aperture
- Choice of output configuration
- Choice of opaque or IR transmissive shell material
- Data rates to 250 kBaud
- 24" min, 26AWG wire leads

Description

The OPB900W and OPB910W series of Photologic[®] Photo Integrated Circuit Switches provide optimum flexibility for the design engineer. Building from a standard housing with a 0.375" (9.53 mm) wide slot, the user can specify (1) type and polarity of TTL output and (2) discrete shell material.

The electrical output can be specified as either TTL totem pole or TTL open collector. Either may be supplied with inverter or buffer output polarity. All have added stability of a built-in hysteresis amplifier.

Absolute Maximum Ratings (T_A = 25° C unless otherwise noted)

Supply Voltage, V _{CC} (Not to exceed 3 sec.)	10 V
Storage Temperature Range	-40° C to +80° C
Operating Temperature Range	-40° C to +70° C
Input Diode Power Dissipation	100 mW ⁽¹⁾
Output Photologic [®] Power Dissipation	200 mW ⁽²⁾
Total Device Power Dissipation	300 mW ⁽³⁾
Voltage at Output Lead (Open Collector Output)	35 V
Diode Forward D.C. Current	40 mA
Diode Reverse D.C. Voltage	2 V

Notes:

- (1) Derate linearly 2.22 mW/° C above 25° C.
- (2) Derate linearly 4.44 mW/° C above 25° C.
- (3) Derate linearly 6.66 mW/° C above 25° C.
- (4) The OPB900W/OPB910W series are terminated with 24 inches of 7 strand 26 AWG, UL 1429 insulated wire on each terminal. Insulation function and colors are :

Red - IRED Anode	White - V _{CC}
Black - IRED Cathode	Blue - Output
	Green - Ground

Other wire lengths and/or colors in addition to customer selected connectors are available. Contact your local representative or call the factory.

- (5) Normal application would be with light source blocked, simulated by I_F = 0 mA.
- (6) All parameters tested using pulse technique.
- (7) Methanol and isopropanol are recommended as cleaning agents. Housings are soluble in chlorinated hydrocarbons and ketones.

■ 6798580 0003106 209 ■

Types OPB900W, OPB910W Series

6798580 0003107 145

Electrical Characteristics (T_A = -40° C to +70° C unless otherwise noted)

SYMBOL	PARAMETER	MIN	TYP	MAX	UNITS	TEST CONDITIONS
Input Diode						
V _F	Forward Voltage			1.7	V	I _F = 20 mA, T _A = 25° C
I _R	Reverse Current			100	μA	V _R = 2 V, T _A = 25° C
Output Photologic[®] Sensor						
V _{CC}	Operating D.C. Supply Voltage	4.75		5.25	V	
I _{CCL}	Low Level Supply Current: Buffered Totem-Pole Output Buffered Open-Collector Output			15	mA	V _{CC} = 5.25 V, I _F = 0 mA ⁽⁵⁾
	Inverted Totem-Pole Output Inverted Open-Collector Output			15	mA	V _{CC} = 5.25 V, I _F = 20 mA
I _{CCH}	High Level Supply Current: Buffered Totem-Pole Output Buffered Open-Collector Output			15	mA	V _{CC} = 5.25 V, I _F = 20 mA
	Inverted Totem-Pole Output Inverted Open-Collector Output			15	mA	V _{CC} = 5.25 V, I _F = 0 mA ⁽⁵⁾
V _{OL}	Low Level Output Voltage: Buffered Totem-Pole Output Buffered Open-Collector Output			0.4	V	V _{CC} = 4.75 V, I _{OL} = 12.8 mA I _F = 0 mA ⁽⁵⁾
	Inverted Totem-Pole Output Inverted Open-Collector Output			0.4	V	V _{CC} = 4.75 V, I _{OL} = 12.8 mA I _F = 20 mA
V _{OH}	High Level Output Voltage: Buffered Totem-Pole Output	2.4			V	V _{CC} = 4.75 V, I _{OH} = -800 μA I _F = 20 mA
	Inverted Totem-Pole Output	2.4			V	V _{CC} = 4.75 V, I _{OH} = -800 μA I _F = 0 mA ⁽⁵⁾
I _{OH}	High Level Output Current: Buffered Open-Collector Output			100	μA	V _{CC} = 4.75 V, V _{OH} = 30 V I _F = 20 mA, T _A = 25° C
	Inverted Open-Collector Output			100	μA	V _{CC} = 4.75 V, V _{OH} = 30 V I _F = 0 mA, T _A = 25° C
I _{F(+)}	LED Positive-Going Threshold Current			20	mA	V _{CC} = 5 V, T _A = 25° C
I _{F(+)} /I _{F(-)}	Hysteresis		2.0			V _{CC} = 5 V
I _{OS}	Short Circuit Output Current: Buffered Totem-Pole Output	-30		-100	mA	V _{CC} = 5.25 V, I _F = 20 mA Output = GND
	Inverted Totem-Pole Output	-30		-100	mA	V _{CC} = 5.25 V, I _F = 0 mA Output = GND
t _r , t _f	Output Rise Time, Output Fall Time		70		ns	V _{CC} = 5 V, T _A = 25° C
t _{PLH} , t _{PHL}	Propagation Delay Low-High & High-Low		5.0		μs	I _F = 0 or 20 mA R _L = 8 TTL Loads (Totem-Pole) R _L = 360 Ω (Open-Collector)

SLOTTED
OPTICAL
SWITCHES

Housing

All housings are an opaque grade of injection-molded plastic to minimize the assembly's sensitivity to ambient radiation, both visible and near-infrared. Discrete shells (exposed on the parallel faces inside the device throat) are either IR transmissive plastic for applications where aperture contamination may occur or opaque plastic for maximum protection against ambient light.

Optek reserves the right to make changes at any time in order to improve design and to supply the best product possible.

Optek Technology, Inc. 1215 W. Crosby Road Carrollton, Texas 75006 (972)323-2200 Fax (972)323-2396

PART NUMBER GUIDE

OPB 9 X X X X X

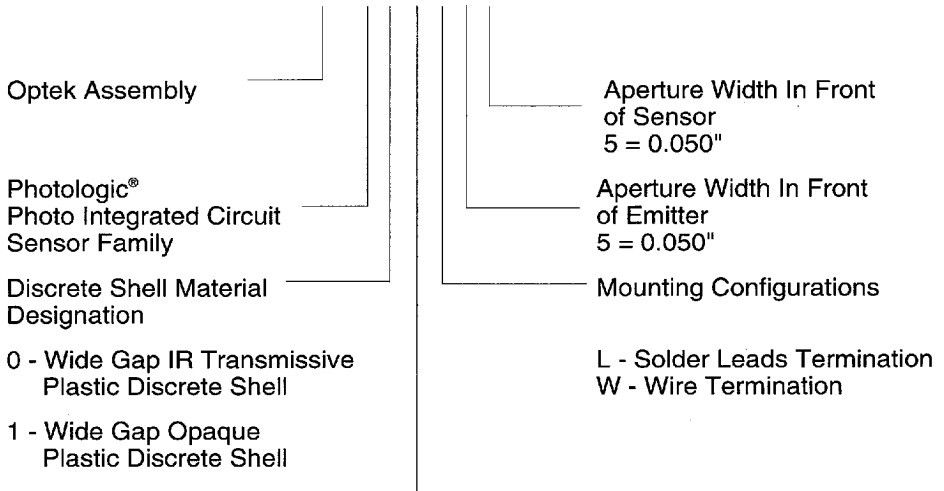

Electrical Specification Variations

- 0 - Buffered Totem-Pole Output
- 1 - Buffered Open-Collector Output
- 2 - Inverted Totem-Pole Output
- 3 - Inverted Open-Collector Output

Schematics

**OPB900/OPB910
(Totem-Pole Output)
Buffer**

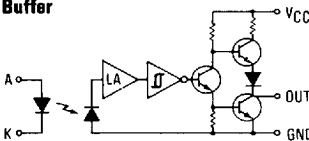

**OPB901/OPB911
(Open-Collector Output)
Buffer**

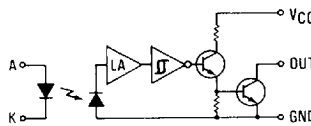

**OPB902/OPB912
(Totem-Pole Output)
Inverter**

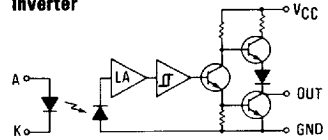

**OPB903/OPB913
(Open-Collector Output)
Inverter**

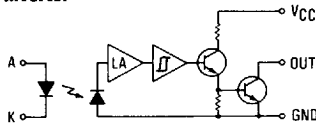

■ 6798580 0003108 081 ■

Types OPB900W, OPB910W Series

Typical Performance Curves

OPB900L, OPB902L, OPB910L, OPB912L

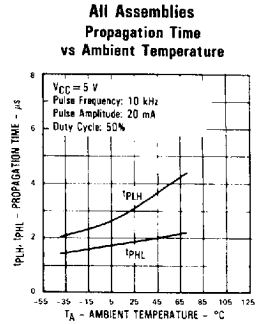
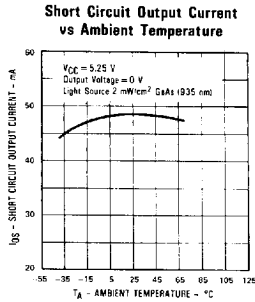
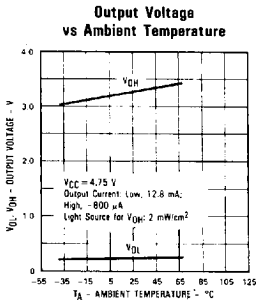

SLOTTED OPTICAL SWITCHES

OPB901L, OPB903L, OPB911L, OPB913L

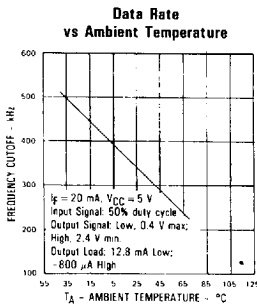
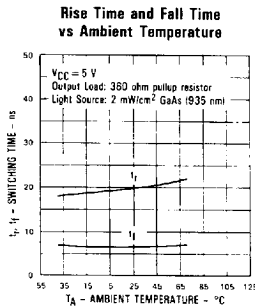
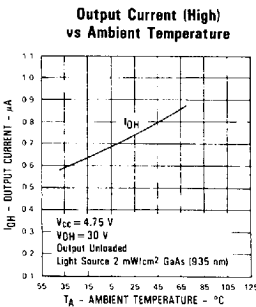

OPB900L, OPB901L, OPB910L, OPB911L

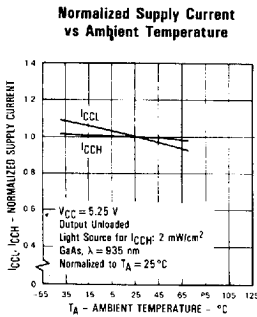

OPB902L, OPB903L, OPB912L, OPB913L

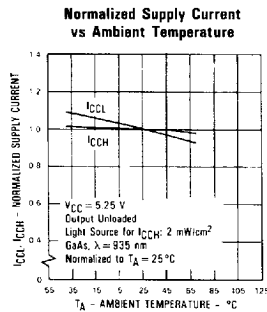

All Assemblies

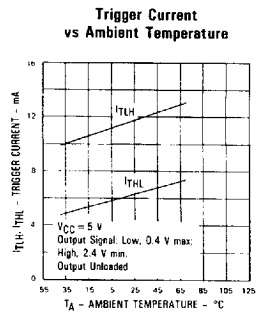

Switching Test Curve for Buffers

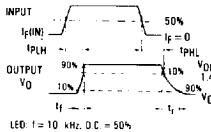

Switching Test Curve for Inverters

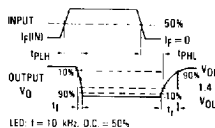

6798580 0003109 T18

Optek reserves the right to make changes at any time in order to improve design and to supply the best product possible.

Optek Technology, Inc. 1215 W. Crosby Road Carrollton, Texas 75006 (972)323-2200 Fax (972)323-2396