

## 50W 5-Line Array Surface Mount TVS Diodes

### FEATURES

- Protects five I/O lines
- 5V working voltage
- Transient protection for data, signal, and Vcc bus to IEC 61000-4-2 (ESD) & IEC 61000-4-4 (EFT)
- Low Leakage Current
- Solid state silicon avalanche technology
- Low operating and clamping voltages

### MECHANICAL DATA

- JEDEC SOT-563 package
- Solder temperature: 265°C for 10 seconds
- Readily solderable terminals

### APPLICATION

- Cordless phones
- Cellular phones & accessories
- Audio/Video inputs
- Portable electronics (Digital Cameras, MP3 Players, etc.)
- Networks

The **N505AT56 Series** of transient voltage suppressors are designed to protect components which are connected to multi-line data and transmission lines from over voltages caused by electrostatic discharge (ESD), electrical fast transients (EFT), and induced lightning.

### SCHEMATIC & PIN CONFIGURATION

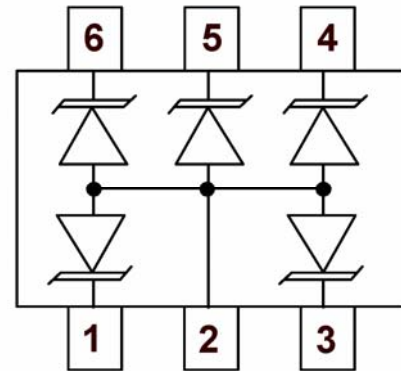

### MAXIMUM RATINGS

RATING	SYMBOL	VALUE	UNIT
Peak Pulse Power (tp = 8 x 20 μs)	P <sub>pk</sub>	40	W
Operating Temperature	T <sub>j</sub>	-55 to +150	°C
Storage Temperature	T <sub>stg</sub>	-55 to +150	°C

### ELECTRICAL CHARACTERISTICS

PARAMETER	SYMBOL	CONDITIONS	MIN.	TYP.	MAX.	UNIT
Reverse Breakdown Voltage	V <sub>BR</sub>	I <sub>t</sub> = 1mA	6.15	6.5	7.15	V
Clamping Voltage	V <sub>C</sub>	I <sub>pp</sub> = 1A <sup>1</sup>	-	-	9	V
Maximum Peak Pulse Current	I <sub>pp</sub>	t <sub>p</sub> = 8/20μs	-	-	3.5	A
Reverse Leakage Current	I <sub>R</sub>	V <sub>RWM</sub> = 5V	-	10	35	μA
Diode Capacitance	C <sub>D</sub>	V <sub>R</sub> = 0V, f = 1MHz	-	22	28	pF
Differential Resistance	r <sub>diff</sub>	I <sub>r</sub> = 1mA	-	20	100	Ohms

Note:

1. Clamping voltage values are based upon an industry standard 8 x 20μs peak pulse current (I<sub>pp</sub>) waveform.

August 2007 / Rev.5

**Non-Repetitive Peak Pulse Power vs. Pulse Time**

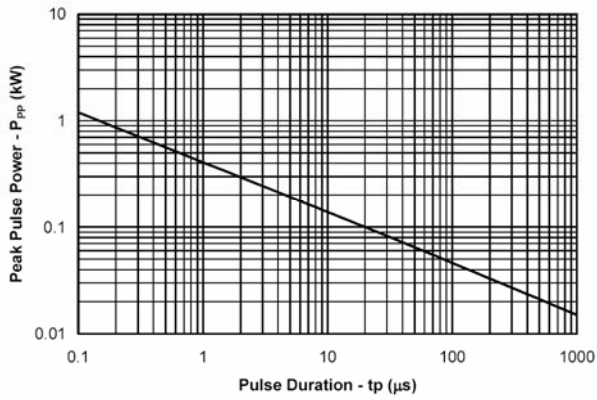

**Power Derating Curve**

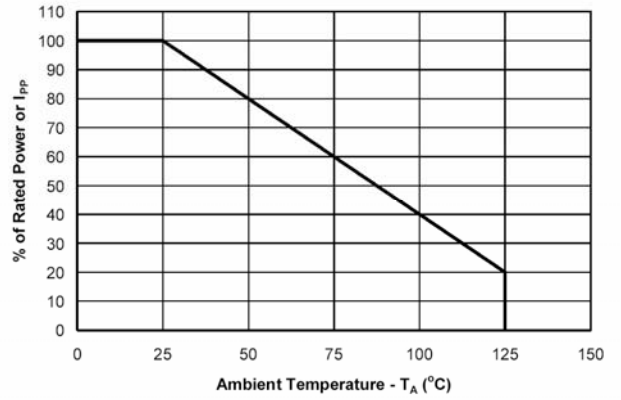

**Clamping Voltage vs. Peak Pulse Current**

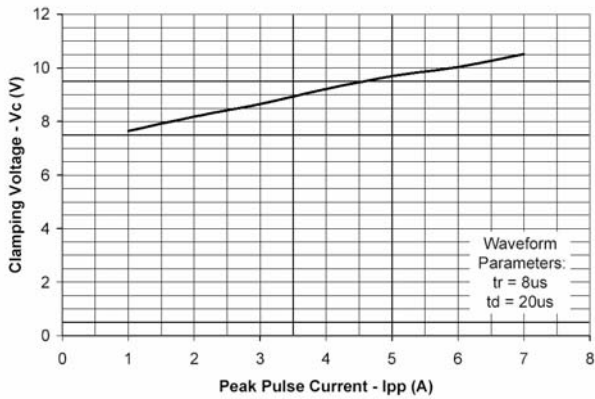

**Forward Voltage vs. Forward Current**

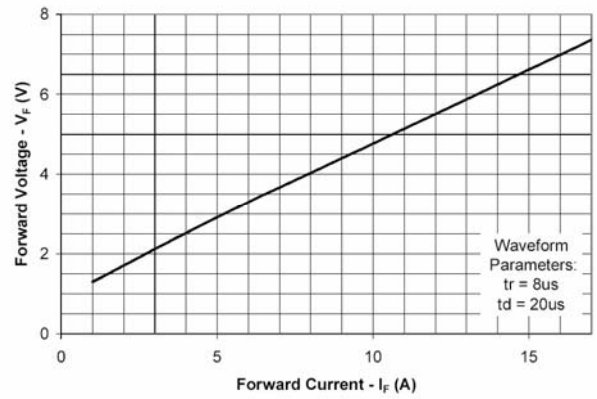

**Junction Capacitance vs. Reverse Voltage**

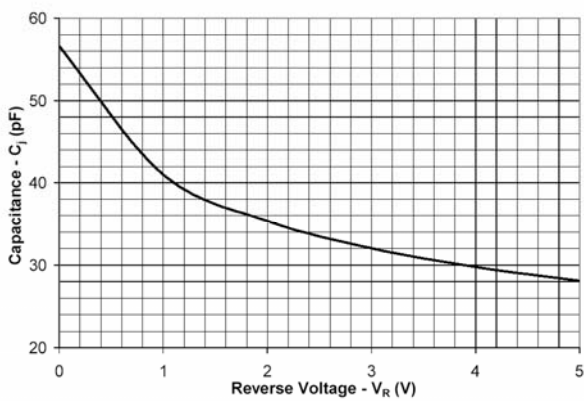

**Insertion Loss S21**

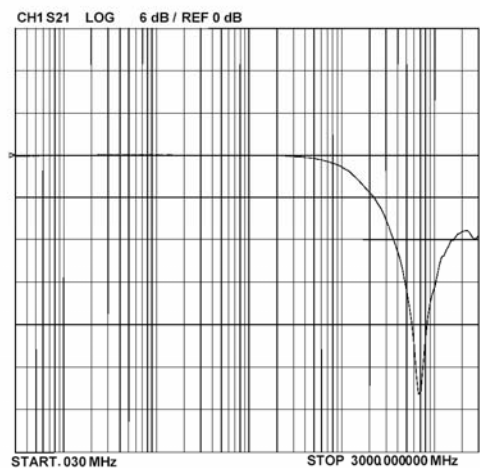

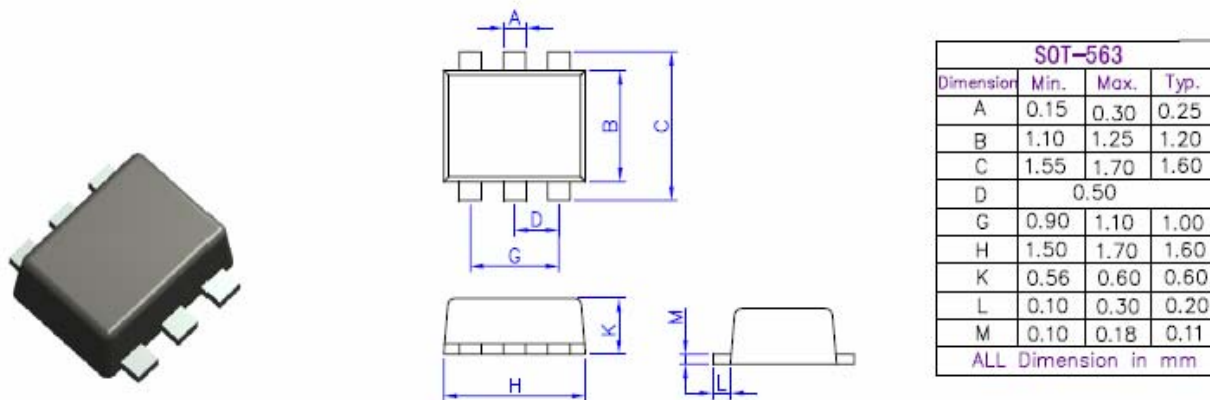
**PACKAGE DIMENSIONS****MARKING CODE**