

# SK 50 DGDL 066 T

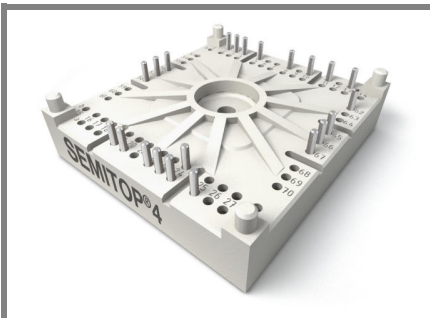

**SEMITOP®4**

**3-phase bridge rectifier +  
brake chopper + 3-phase  
bridge inverter**  
**SK 50 DGDL 066 T**

Preliminary Data

## Features

- One screw mounting module
- Fully compatible with SEMITOP®1,2,3
- Improved thermal performances by aluminium oxide substrate
- Trench IGBT technology
- CAL technology free-wheeling diode
- Integrated NTC temperature sensor

## Typical Applications\*

- Inverter up to 12,5 kVA
- Typical motor power 5,5 kW

## Remarks

- $V_{CE,sat}$ ,  $V_F$  = chip level value

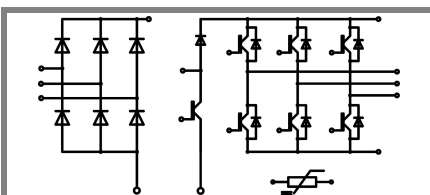

DGDL - T

Absolute Maximum Ratings		$T_s = 25^\circ\text{C}$ , unless otherwise specified	
Symbol	Conditions	Values	Units
<b>IGBT - Inverter, Chopper</b>			
$V_{CES}$		600	V
$I_C$	$T_s = 25 (70)^\circ\text{C}$ , $T_j = 175^\circ\text{C}$	69 (55)	A
$I_C$	$T_s = 25 (70)^\circ\text{C}$ , $T_j = 150^\circ\text{C}$	62 (47)	A
$I_{CRM}$	$I_{CRM} = 2 \times I_{Cnom}$ , $t_p = 1 \text{ ms}$	100	A
$V_{GES}$		$\pm 20$	V
$T_j$		-40 ... + 175	$^\circ\text{C}$
<b>Diode - Inverter, Chopper</b>			
$I_F$	$T_s = 25 (70)^\circ\text{C}$ , $T_j = 150^\circ\text{C}$	48 (35)	A
$I_F$	$T_s = 25 (70)^\circ\text{C}$ , $T_j = 175^\circ\text{C}$	54 (42)	A
$I_{FRM}$	$I_{FRM} = 2 \times I_{Fnom}$ , $t_p = 1 \text{ ms}$	56	A
<b>Diode - Rectifier</b>			
$V_{RRM}$		800	V
$I_F$	$T_s = 70^\circ\text{C}$	35	A
$I_{FSM}$	$t_p = 10 \text{ ms}$ , $\sin 180^\circ$ , $T_j = 25^\circ\text{C}$	370	A
$i^2t$	$t_p = 10 \text{ ms}$ , $\sin 180^\circ$ , $T_j = 25^\circ\text{C}$	680	$\text{A}^2\text{s}$
$T_j$		-40 ... + 175	$^\circ\text{C}$
$T_{sol}$	Terminals, 10 s	260	$^\circ\text{C}$
$T_{stg}$		-40 ... + 125	$^\circ\text{C}$
$V_{isol}$	AC, 1 min.	2500	V

Characteristics		$T_s = 25^\circ\text{C}$ , unless otherwise specified			Units
Symbol	Conditions	min.	typ.	max.	Units
<b>IGBT - Inverter, Chopper</b>					
$V_{CE(sat)}$	$I_{Cnom} = 50 \text{ A}$ , $T_j = 25 (150)^\circ\text{C}$	1,05	1,45 (1,65)	1,85 (2,05)	V
$V_{GE(th)}$	$V_{GE} = V_{CE}$ , $I_C = 0,8 \text{ mA}$	5	5,8	6,5	V
$V_{CE(TO)}$	$T_j = 25 (150)^\circ\text{C}$		0,9 (0,8)	1,1 (1)	V
$r_{CE}$	$T_j = 25 (150)^\circ\text{C}$		11 (17)	15 (21)	$\text{m}\Omega$
$C_{ies}$	$V_{CE} = 25 \text{ V}$ , $V_{GE} = 0 \text{ V}$ , $f = 1 \text{ MHz}$		3,1		nF
$C_{oes}$	$V_{CE} = 25 \text{ V}$ , $V_{GE} = 0 \text{ V}$ , $f = 1 \text{ MHz}$		0,2		nF
$C_{res}$	$V_{CE} = 25 \text{ V}$ , $V_{GE} = 0 \text{ V}$ , $f = 1 \text{ MHz}$		0,093		nF
$R_{th(j-s)}$	per IGBT		0,95		K/W
$t_{d(on)}$	under following conditions		28		ns
$t_r$	$V_{CC} = 300 \text{ V}$ , $V_{GE} = -7 / + 15 \text{ V}$		32		ns
$t_{d(off)}$	$I_{Cnom} = 50 \text{ A}$ , $T_j = 150^\circ\text{C}$		301		ns
$t_f$	$R_{Gon} = R_{Goff} = 16 \Omega$		45		ns
$E_{on} (E_{off})$	inductive load		2,2 (1,74)		mJ
<b>Diode - Inverter, Chopper</b>					
$V_F = V_{EC}$	$I_F = 37 \text{ A}$ , $T_j = 25 (150)^\circ\text{C}$		1,35 (1,31)		V
$V_{(TO)}$	$T_j = 25 (150)^\circ\text{C}$		(0,85)		V
$r_T$	$T_j = 25 (150)^\circ\text{C}$		(12,6)		$\text{m}\Omega$
$R_{th(j-s)}$	per diode		1,6		K/W
$I_{RRM}$	under following conditions		44		A
$Q_{rr}$	$I_{Fnom} = 50 \text{ A}$ , $V_R = 300 \text{ V}$		4,8		$\mu\text{C}$
$E_{rr}$	$V_{GE} = 0 \text{ V}$ , $T_j = 150^\circ\text{C}$		0,73		mJ
	$di_F/dt = 2438 \text{ A}/\mu\text{s}$				
<b>Diode - Rectifier</b>					
$V_F$	$I_{Fnom} = 25 \text{ A}$ , $T_j = 25^\circ\text{C}$		1,1		V
$V_{(TO)}$	$T_j = 150^\circ\text{C}$		0,8		V
$r_T$	$T_j = 150^\circ\text{C}$		13		$\text{m}\Omega$
$R_{th(j-s)}$	per diode		1,5		K/W
<b>Temperature Sensor</b>					
$R_{ts}$	5 %, $T_r = 25 (100)^\circ\text{C}$		5000(493)		$\Omega$
<b>Mechanical Data</b>					
w			60		g
$M_s$	Mounting torque	2,5		2,75	Nm

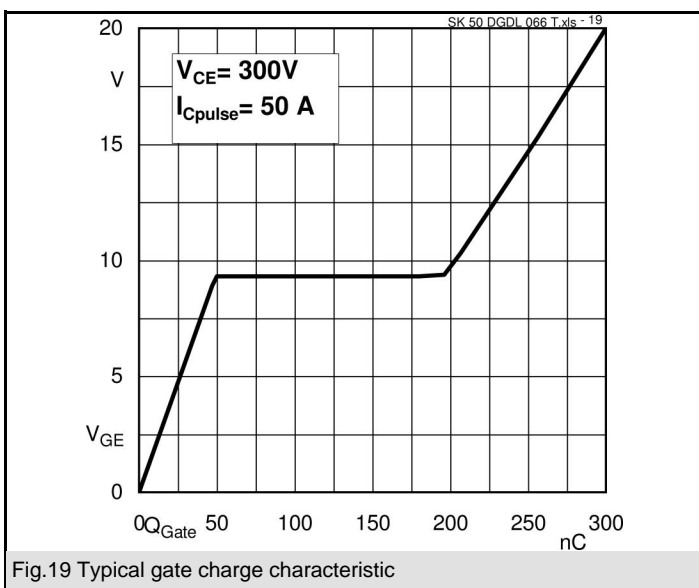
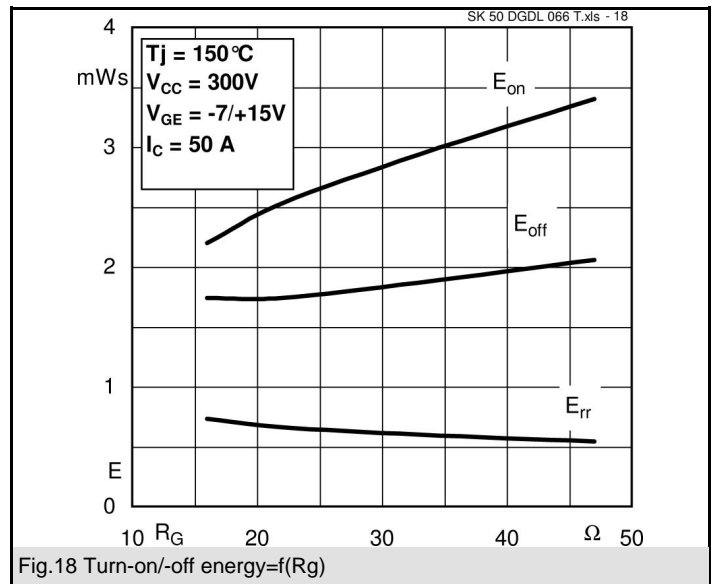
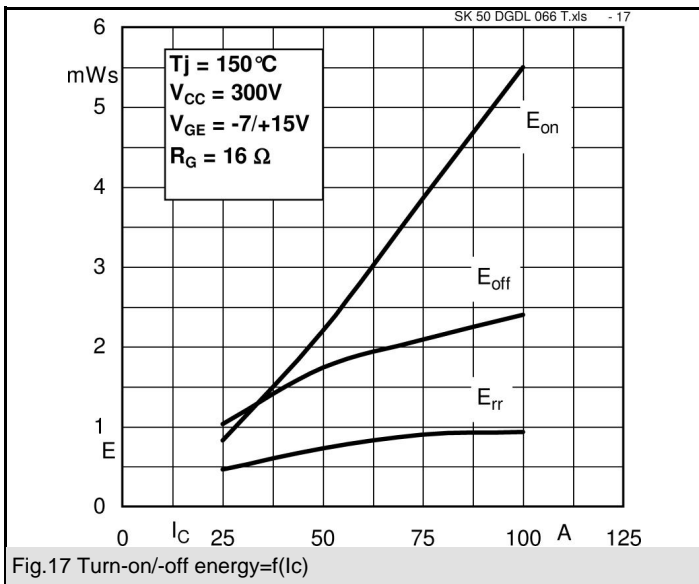
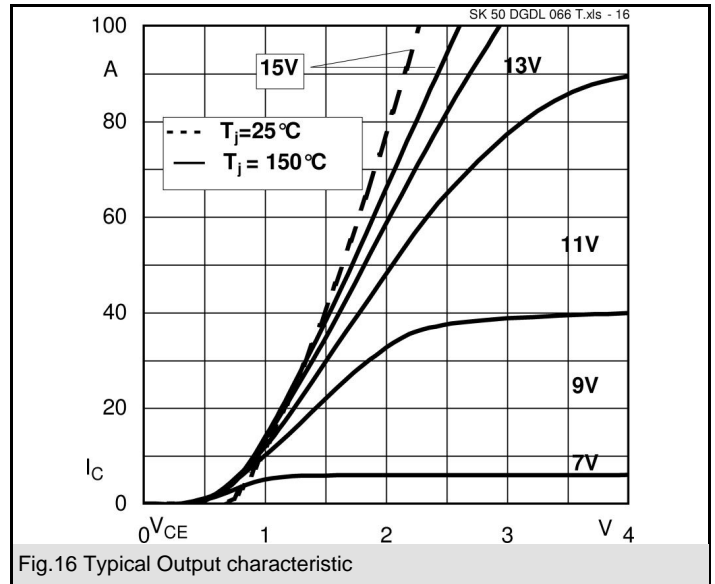
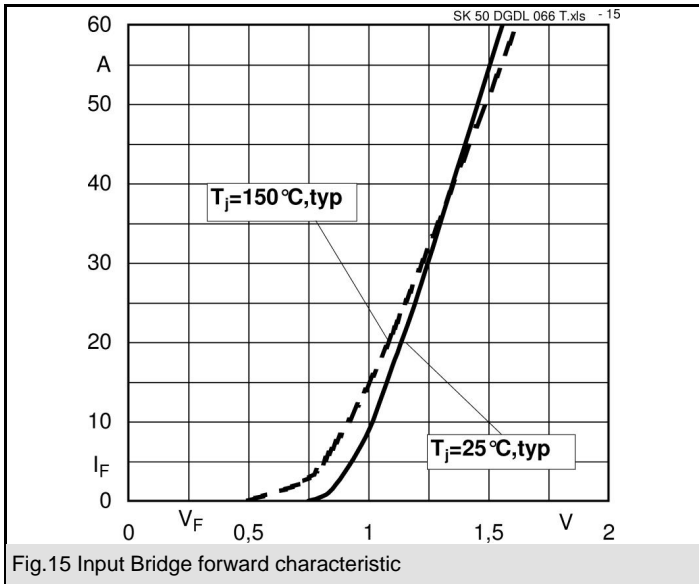

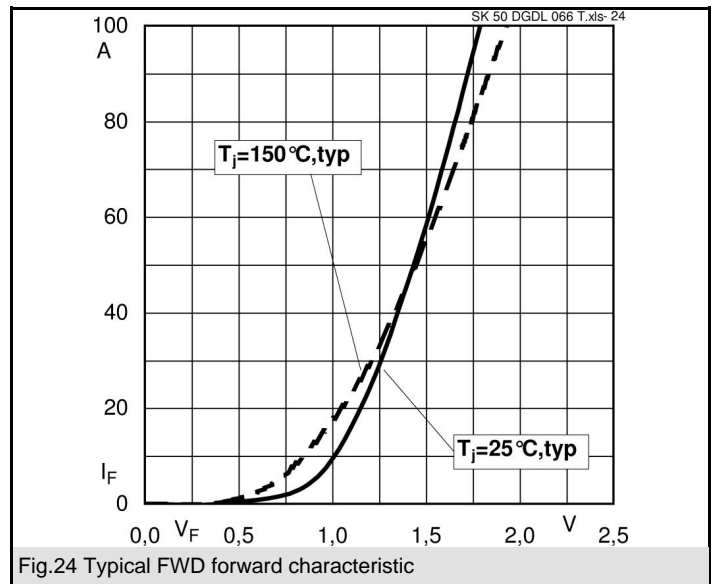
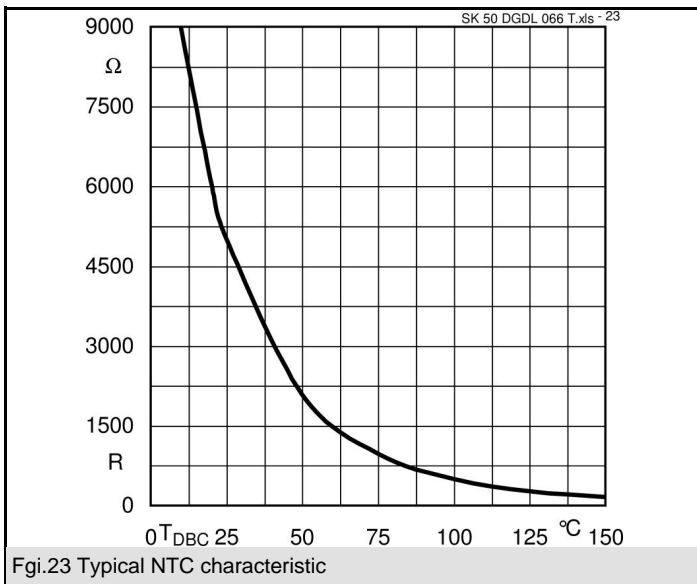
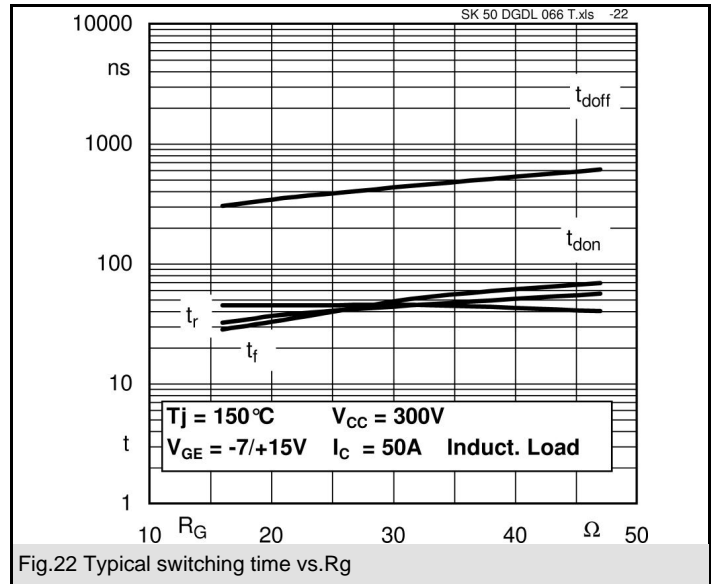
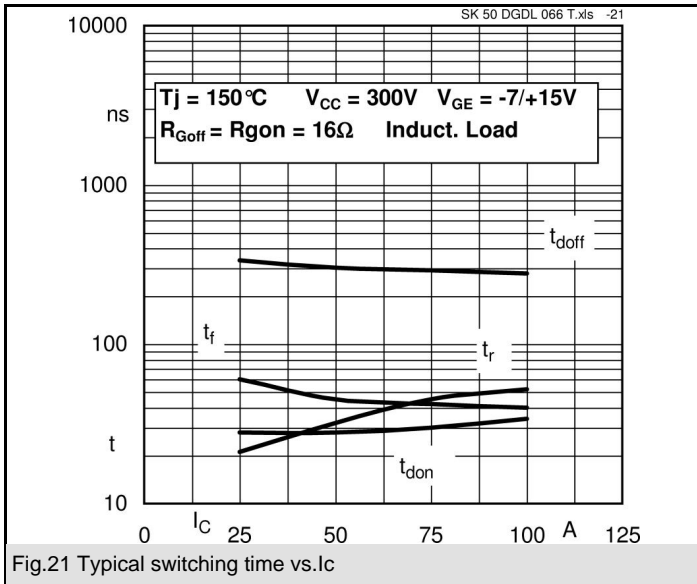

# SK 50 DGDL 066 T

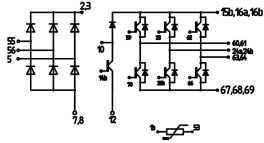

Case T 75  
(pin without  
letter refers  
to row "a",  
unless  
otherwise  
specified)

UL recognized  
file no E 63 532

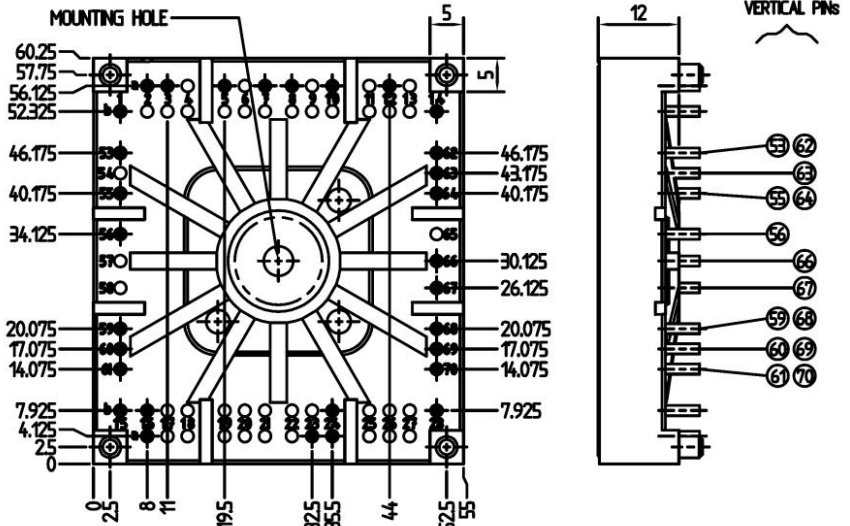
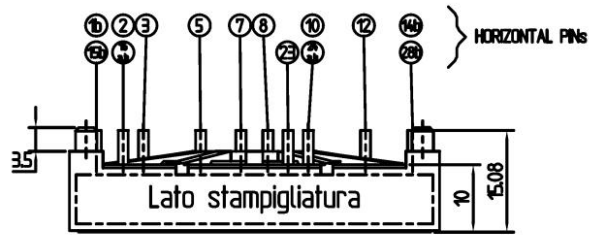

Case T 75 (Suggested hole diameter for the solder pins in the circuit board: 2mm.  
Suggested hole diameter for the mounting pins in the circuit board: 3,6mm )

This is an electrostatic discharge sensitive device (ESDS), international standard IEC 60747-1, Chapter IX.

\* The specifications of our components may not be considered as an assurance of component characteristics. Components have to be tested for the respective application. Adjustments may be necessary. The use of SEMIKRON products in life support appliances and systems is subject to prior specification and written approval by SEMIKRON. We therefore strongly recommend prior consultation of our personal.