

LED Strip Specifications

PRODUCT SPECIFICATION

Model No.: FYLH-5050UX3C-09-12V-BW

Applications:
<ul style="list-style-type: none"> ■ Channel Letters ■ Lighting source for shop windows ■ Indoor Decoration Lighting ■ Advertising Signs ■ Replacement for Neon



CUSTOMER APPROVED SIGNATURES	APPROVED BY	CHECKED BY	PREPARED BY

NINGBO FORYARD OPTOELECTRONICS CO.,LTD.
Add:NO.115 Qixin Road Ningbo Zhejiang China **Zip:**315051
Tel: 0086-574-87933652 87927870 87922206
Fax: 0086-574-87927917
E-mail:Sales@foryard.com (General)
[Http://www.foryard.com](http://www.foryard.com)

Model No.: FYLH-5050UX3C-09-12V-BW

■ Photo

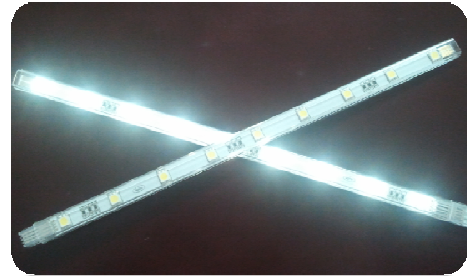

■ Drawing (1 PC)

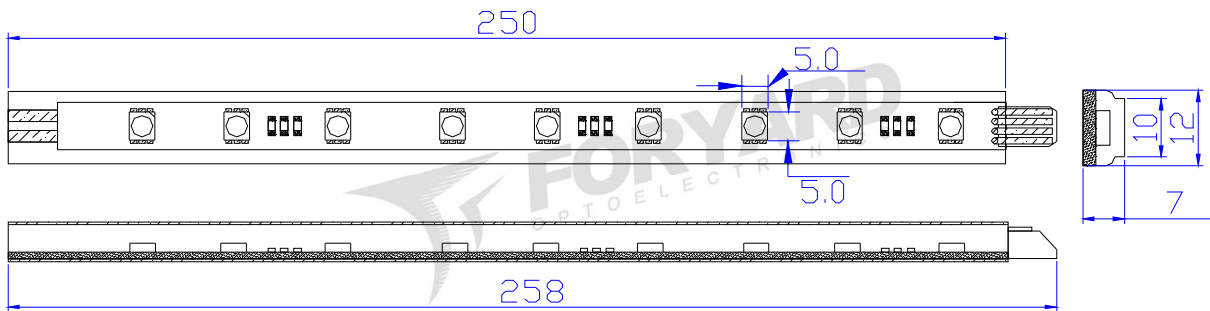

Notes:

1. All dimensions are millimeters.
2. Tolerance is $\pm 0.2\text{mm}$ unless otherwise specified.
3. Specifications are subject to change without notice.
4. Dimension: L250*W12*H7mm.without prior notice.

■ Circuit Diagram(1PC)

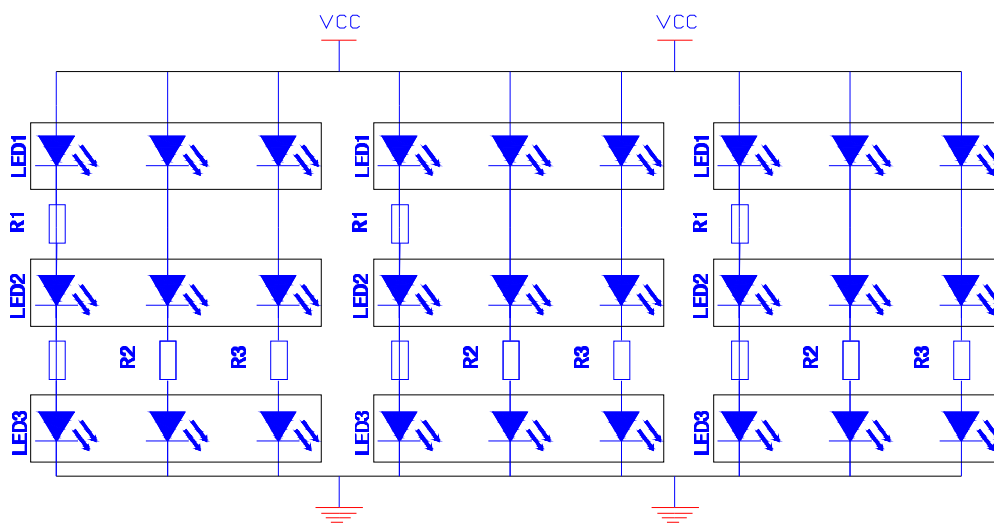



Model No.: FYLH-5050UX3C-09-12V-BW



■ Rating Electrical/Optical Characteristics(1PC)

Item	Red	Yellow	Blue	Green	White
Operation Voltage(V)	DC12	DC12	DC12	DC12	DC12
Power Dissipation(W)	2.7	2.7	2.7	2.7	2.7
Input Current(mA)	220	220	220	220	220
Wavelength(nm)	625-635	590-594	465-475	515-525	CCT:5000K-6500K
Single LED Luminous Intensity(MCD)	4500	4800	3000	3200	6000
Luminous Flux(lm)	144	150	90	110	162
Angle(°)	120				
Operation Temperature(°C)	-20~60				
single LED Operating	20				
LED Quantity(pcs)	60				
Dimension:(mm)	L250*W12*H7mm				
Life Time(hrs)	50000				
net weight:(g)	16				
Approval	CE(NO:E8N 08 03 57489 001)				

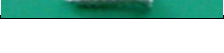
■ Standard Configuration

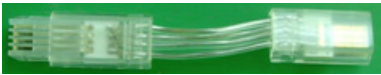
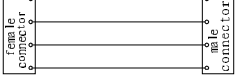

Name	Specs	Number	Photo
LED Linear strip	L*W*H=258*12*7mm	2PCS	Refer to the photo in page 1
Power Lead	1007 24AWG 2m	1PCS	
End cap	Material:pc	1PCS	
Clip	Material:pc	4PCS	
Screw	PA 2.5X5	4PCS	

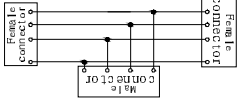
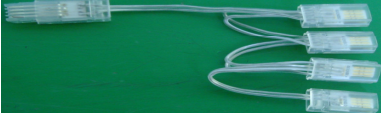
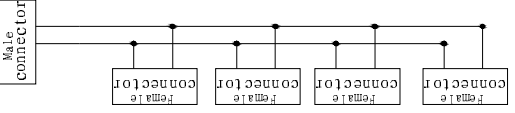
■ Accessory for Option (Interconnector Series)

Name	Photo	Structure Drawing
One-to-one connector		
One-to-two connector		
One-to-four connector		

Model No.: FYLH-5050UX3C-09-12V-BW

■ Accessory for Option (Power Supply Series)

Name	Specs	The most conjunction linear number	Photo
Switch Power Supply	30W (12V/2.5A)	10pcs	
	150W (12V/12.5A)	55pcs	

■ Use Demonstration

1. End to end.

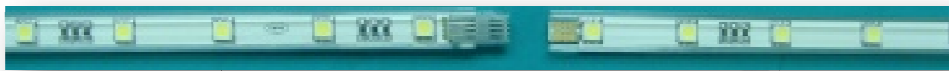

2. Connection finished.

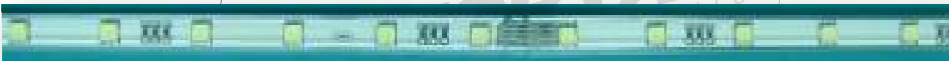

3. The connection between power lead and strip



4. Connection finished.

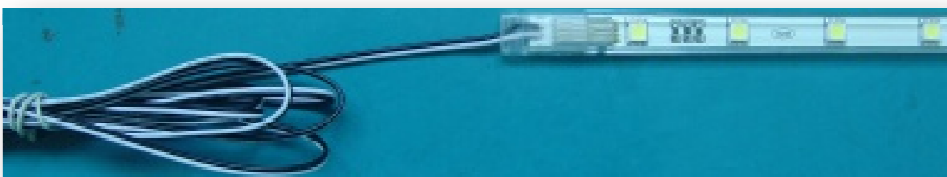

5. Press the strip into the clip instead of inserting into the clip.



6. Insert the end cap from the end of the linear strip.



7. When connected to the power supply, the white wire is anode, while the black wire is cathode.

Notes:

Package

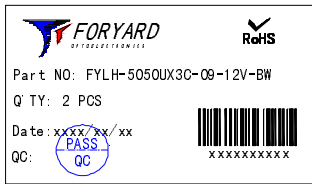
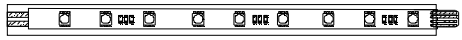

2Pcs / Polybag

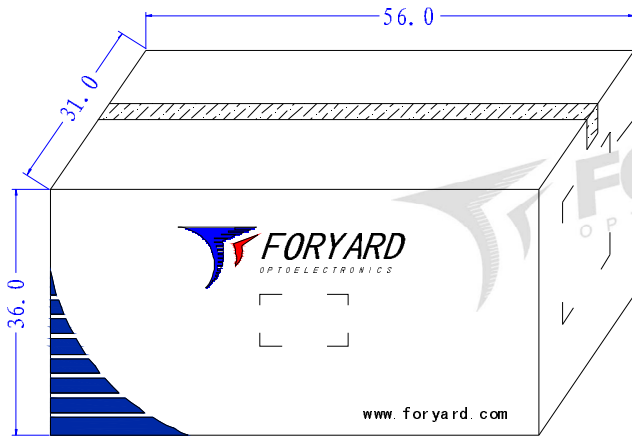

4Boxes/Carton

OUTSIDE LABEL

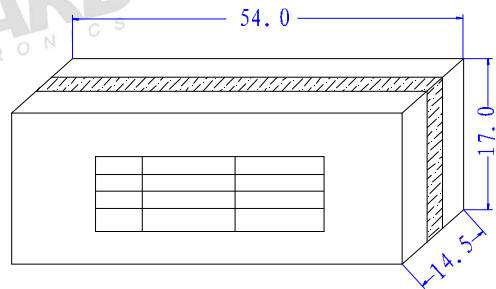

200 Bags/Box



OUTSIDE LABEL