

V_{RSM}	=	2800 V
$I_{F(AV)M}$	=	7385 A
$I_{F(RMS)}$	=	11600 A
I_{FSM}	=	87×10^3 A
V_{F0}	=	0.8 V
r_F	=	0.05 mW

Rectifier Diode

5SDD 60Q2800

Doc. No. 5SYA1161-01 Feb. 05

- Patented free-floating silicon technology
- Very low on-state losses
- Optimum power handling capability

Blocking

Maximum rated values ¹⁾

Parameter	Symbol	Conditions	Value	Unit
Repetitive peak reverse voltage	V_{RRM}	$f = 50$ Hz, $t_p = 10$ ms, $T_j = 160^\circ\text{C}$	2000	V
Non-repetitive peak reverse voltage	V_{RSM}	$f = 5$ Hz, $t_p = 10$ ms, $T_j = 160^\circ\text{C}$	2800	V

Characteristic values

Parameter	Symbol	Conditions	min	typ	max	Unit
Max. (reverse) leakage current	I_{RRM}	V_{RRM} , $T_j = 160^\circ\text{C}$			400	mA

Mechanical data

Maximum rated values ¹⁾

Parameter	Symbol	Conditions	min	typ	max	Unit
Mounting force	F_M		81	90	108	kN
Acceleration	a	Device unclamped			50	m/s^2
Acceleration	a	Device clamped			100	m/s^2

Characteristic values

Parameter	Symbol	Conditions	min	typ	max	Unit
Weight	m			2.1		kg
Housing thickness	H	$F_M = 90$ kN, $T_a = 25^\circ\text{C}$	25.8		26.2	mm
Surface creepage distance	D_S		36			mm
Air strike distance	D_a		15			mm

1) Maximum rated values indicate limits beyond which damage to the device may occur

ABB Switzerland Ltd, Semiconductors reserves the right to change specifications without notice.



On-state

Maximum rated values ¹⁾

Parameter	Symbol	Conditions	min	typ	max	Unit
Max. average on-state current	$I_{F(AV)M}$	50 Hz, Half sine wave, $T_C = 90^\circ\text{C}$			7385	A
Max. RMS on-state current	$I_{F(RMS)}$				11600	A
Max. peak non-repetitive surge current	I_{FSM}	$t_p = 10\text{ ms}$, $T_j = 160^\circ\text{C}$, $V_R = 0\text{ V}$			87×10^3	A
Limiting load integral	I^2t				38.5×10^6	A^2s
Max. peak non-repetitive surge current	I_{FSM}	$t_p = 8.3\text{ ms}$, $T_j = 160^\circ\text{C}$, $V_R = 0\text{ V}$			95×10^3	A
Limiting load integral	I^2t				38×10^6	A^2s

Characteristic values

Parameter	Symbol	Conditions	min	typ	max	Unit
On-state voltage	V_F	$I_F = 5000\text{ A}$, $T_j = 160^\circ\text{C}$		1.05		V
Threshold voltage	$V_{(T0)}$	$T_j = 160^\circ\text{C}$ $I_T = 2500 \dots 7500\text{ A}$			0.8	V
Slope resistance	r_T				0.05	$\text{m}\Omega$

Switching

Characteristic values

Parameter	Symbol	Conditions	min	typ	max	Unit
Recovery charge	Q_{rr}	$di_F/dt = -10\text{ A}/\mu\text{s}$, $V_R = 200\text{ V}$ $I_{FRM} = 4000\text{ A}$, $T_j = 160^\circ\text{C}$			6300	μAs

Thermal

Maximum rated values ¹⁾

Parameter	Symbol	Conditions	min	typ	max	Unit
Operating junction temperature range	T _{vj}				160	°C
Storage temperature range	T _{stg}		-40		175	°C

Characteristic values

Parameter	Symbol	Conditions	min	typ	max	Unit
Thermal resistance junction to case	R _{th(j-c)}	Double-side cooled F _m = 81...108 kN			5	K/kW
	R _{th(j-c)A}	Anode-side cooled F _m = 81...108 kN			10	K/kW
	R _{th(j-c)C}	Cathode-side cooled F _m = 81...108 kN			10	K/kW
Thermal resistance case to heatsink	R _{th(c-h)}	Double-side cooled F _m = 81...108 kN			1	K/kW
	R _{th(c-h)}	Single-side cooled F _m = 81...108 kN			2	K/kW

Analytical function for transient thermal impedance:

$$Z_{th(j-c)}(t) = \sum_{i=1}^n R_{thi} (1 - e^{-t/t_i})$$

i	1	2	3	4
R _{thi} (K/kW)	3.378	0.919	0.426	0.280
τ _i (s)	0.4710	0.0707	0.0074	0.0014

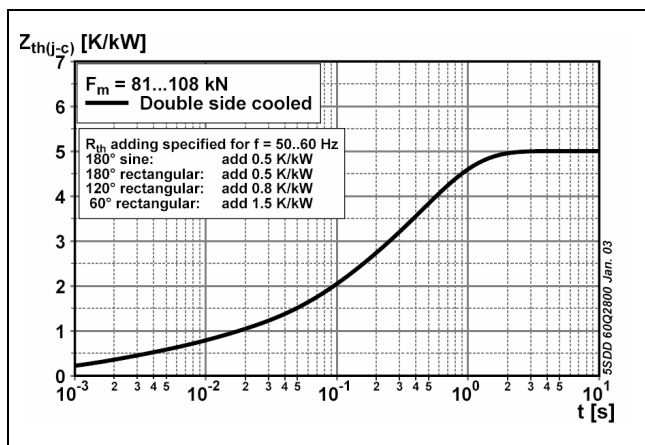

Fig. 1 Transient thermal impedance junction-to-case.

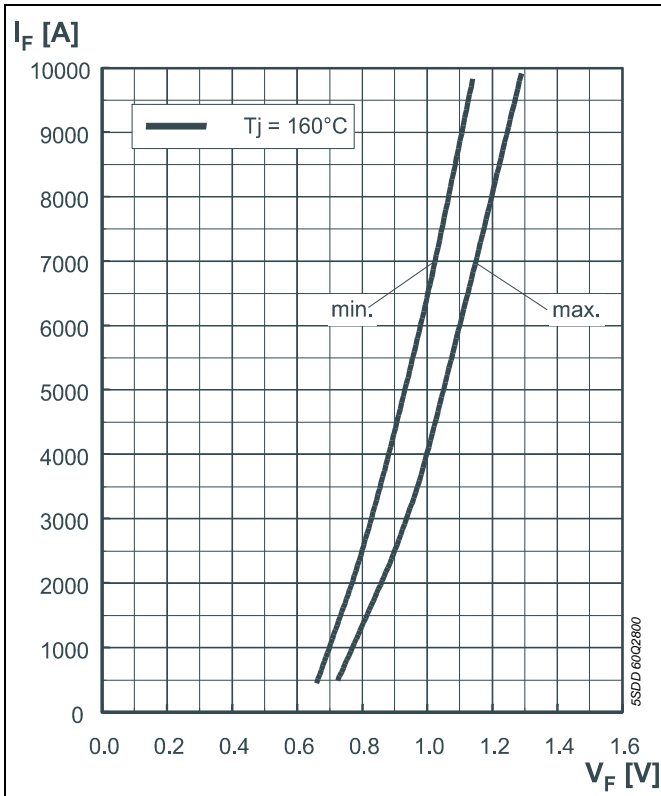

Fig. 2 On-state characteristics.

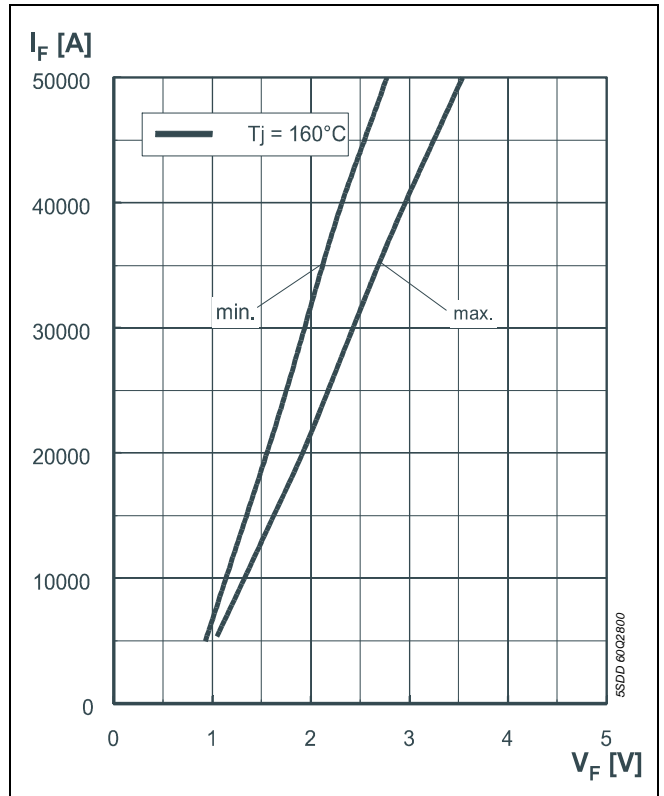

Fig. 3 On-state characteristics.

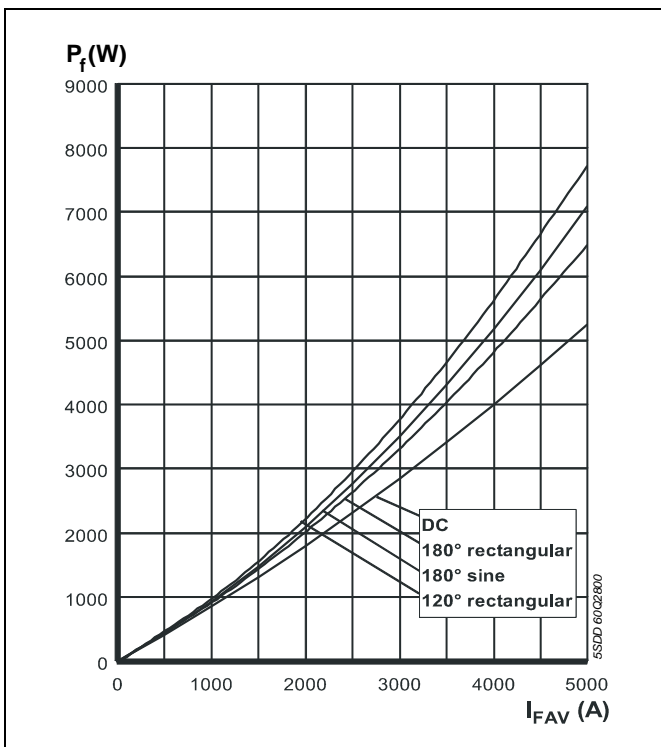

Fig. 4 On-state power losses vs average on-state current.

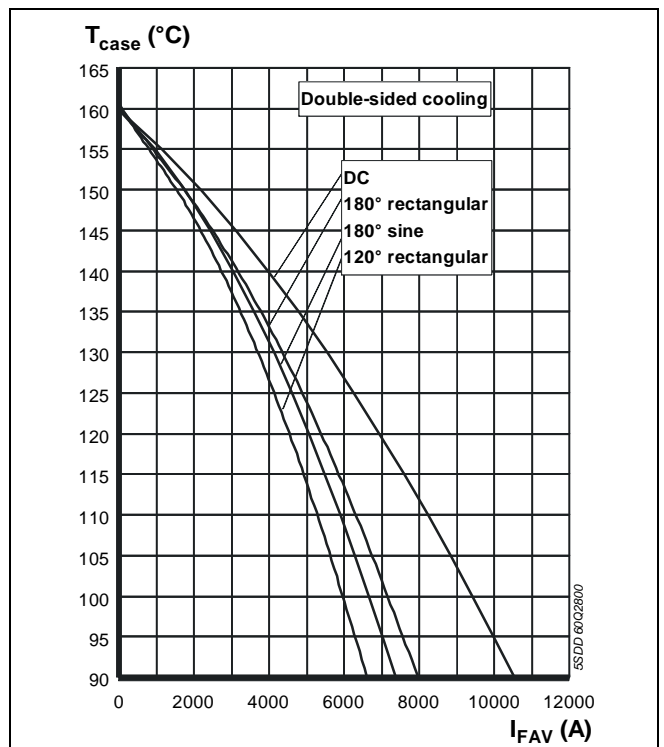

Fig. 5 Max. permissible case temperature vs average on-state current.

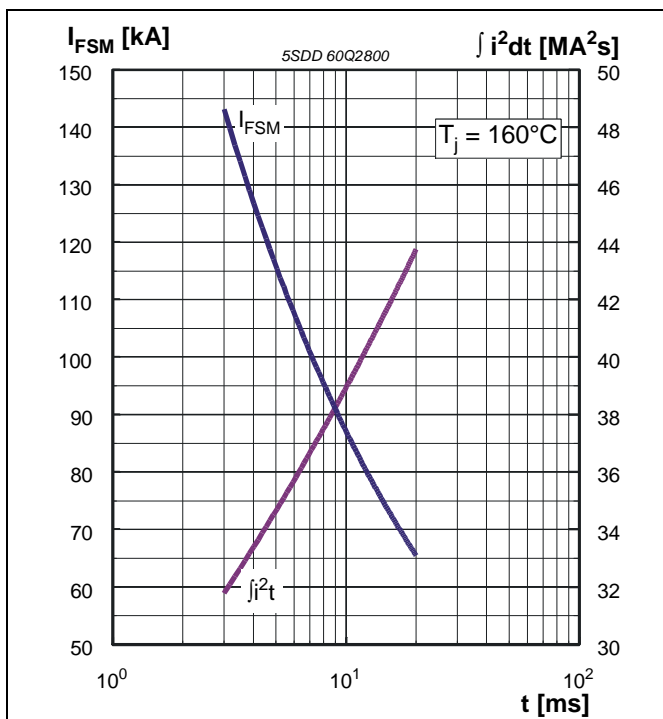

Fig. 6 Surge on-state current vs. pulse length. Half-sine wave.

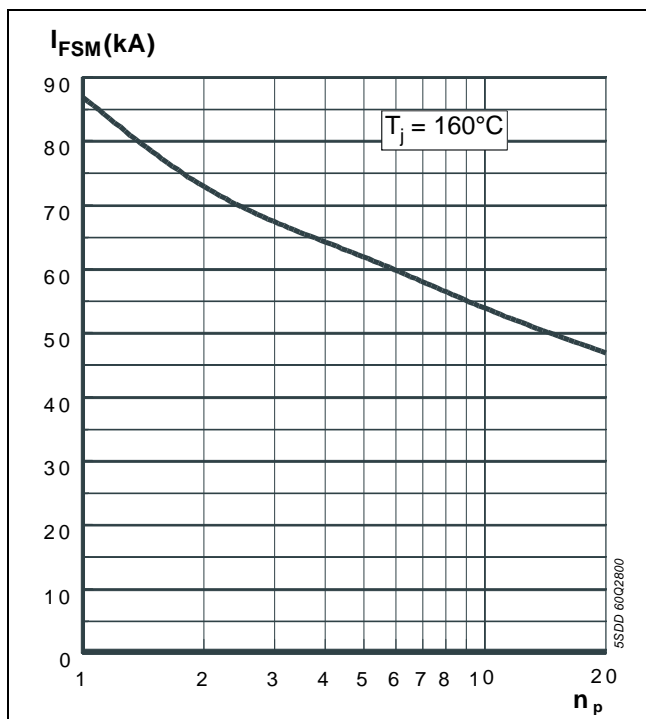

Fig. 7 Surge on-state current vs. number of pulses. Half-sine wave, 10 ms, 50Hz.

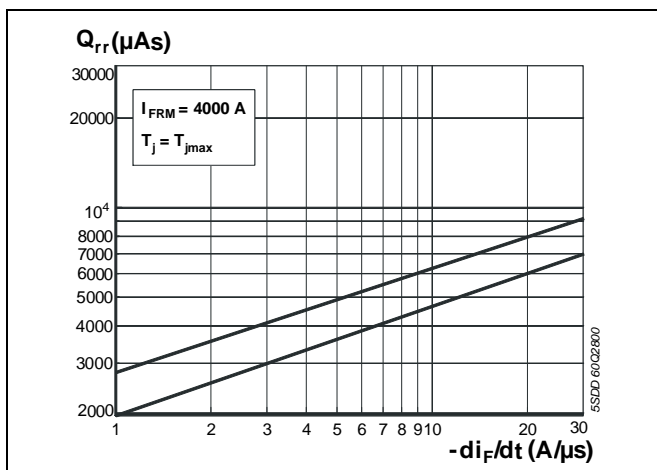

Fig. 8 Recovery charge vs. decay rate of on-state current.

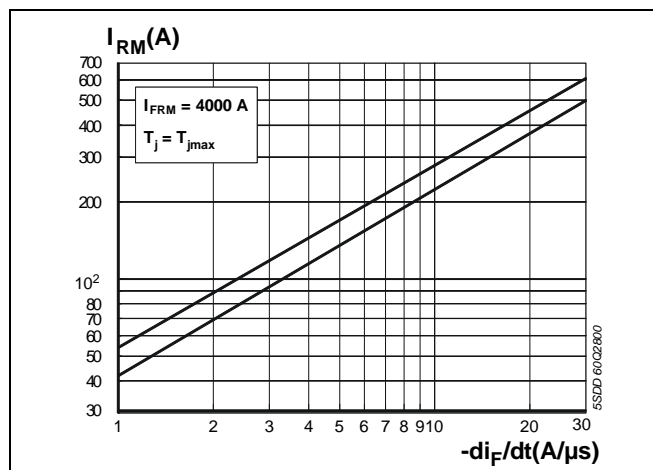

Fig. 9 Peak reverse recovery current vs. decay rate of on-state current.

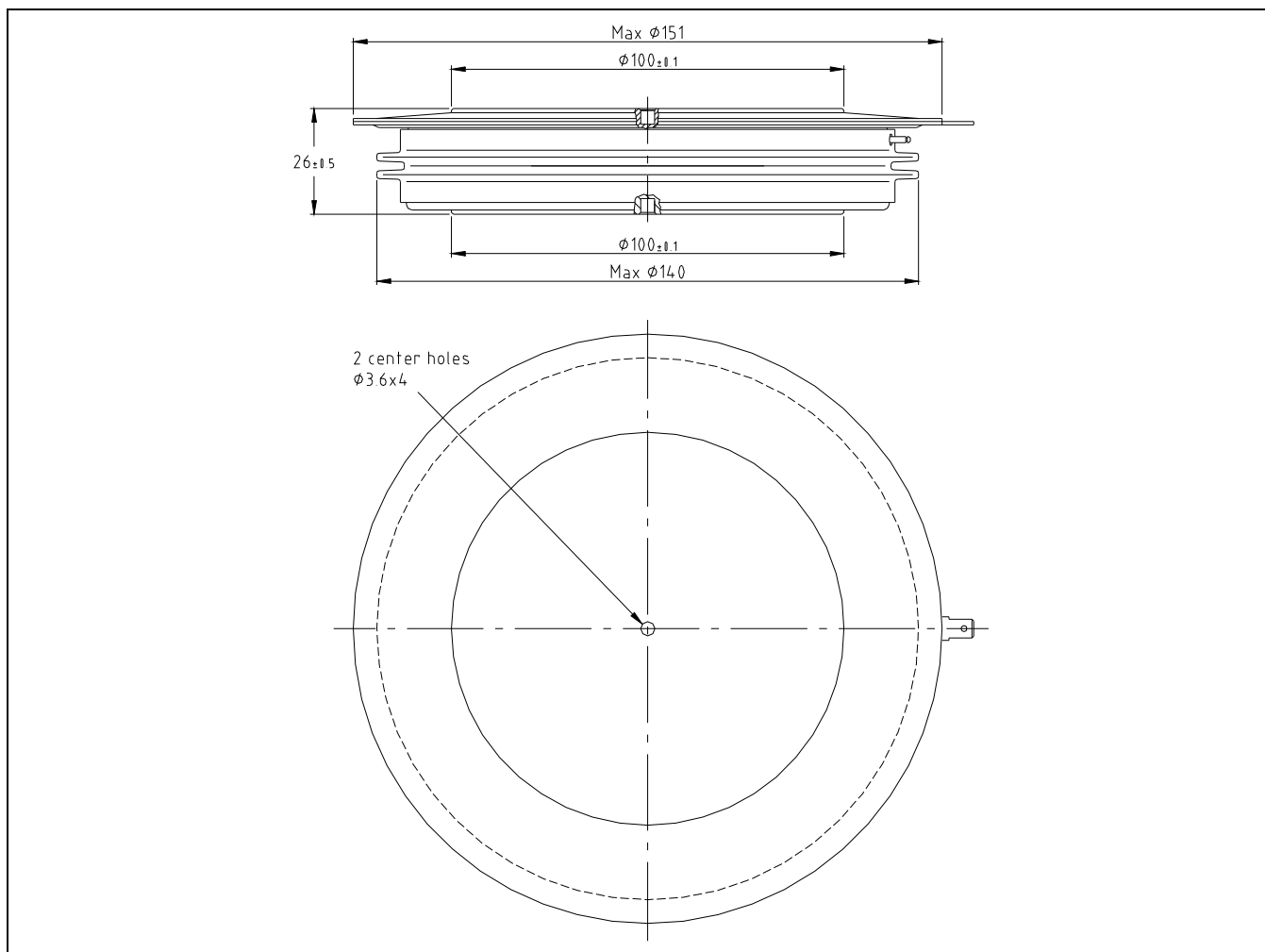

Fig. 10 Outline drawing. All dimensions are in millimeters and represent nominal values unless stated otherwise.

Related application notes:

Doc. Nr	Titel
5SYA 2020	Design of RC-Snubbers for Phase Control Applications
5SYA 2029	Designing Large Rectifiers with High Power Diodes
5SYA 2036	Recommendations regarding mechanical clamping of Press Pack High Power Semiconductors

Please refer to <http://www.abb.com/semiconductors> for actual versions.

ABB Switzerland Ltd, Semiconductors reserves the right to change specifications without notice.



ABB Switzerland Ltd
Semiconductors
 Fabrikstrasse 3
 CH-5600 Lenzburg, Switzerland

Doc. No. 5SYA1161-01 Feb. 05

Telephone +41 (0)58 586 1419
 Fax +41 (0)58 586 1306
 Email abbsem@ch.abb.com
 Internet www.abb.com/semiconductors